

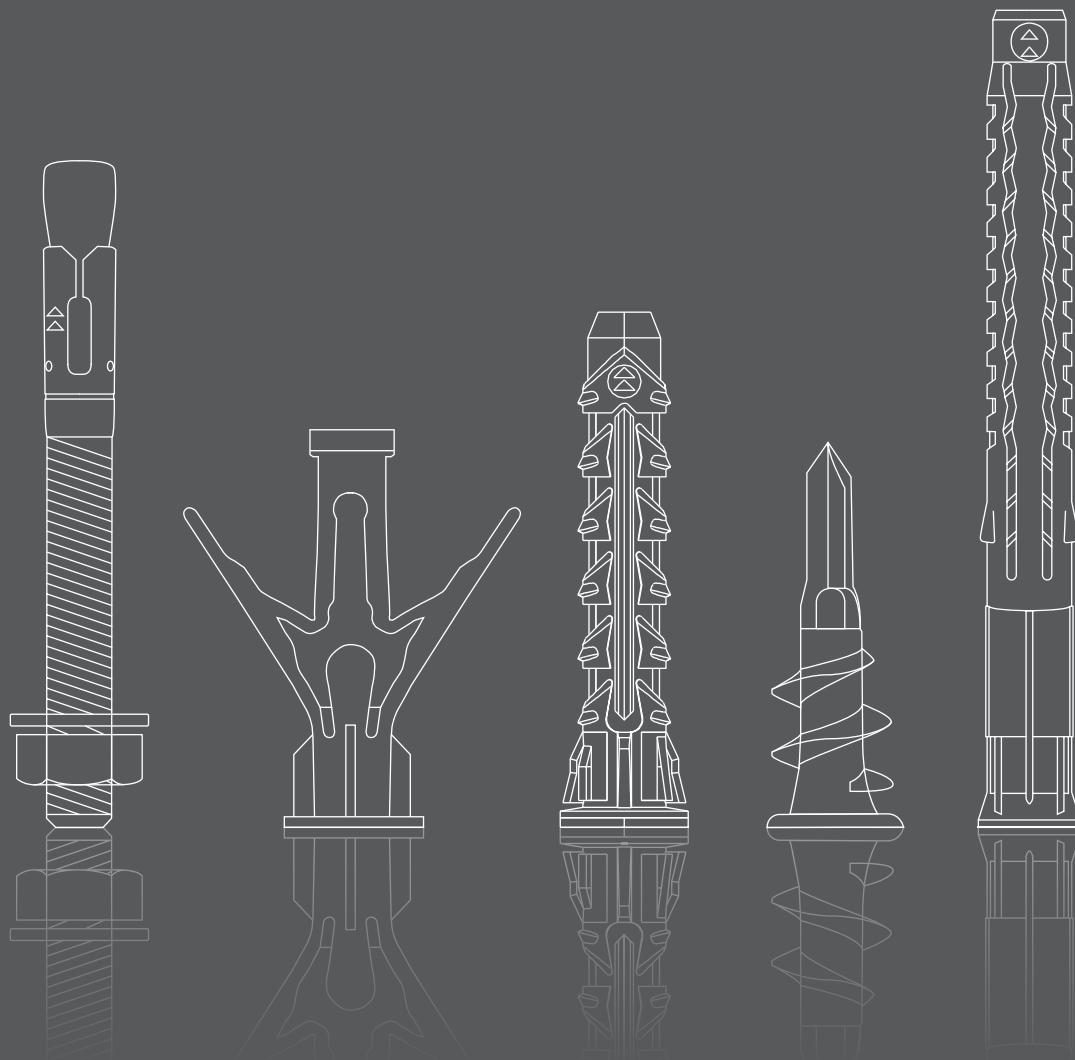

CATALOGO GENERALE

01



KEEP FIXING YOUR FUTURE

IT

nobex.it



Abbiamo il desiderio di spingerci sempre oltre. Perché **ogni traguardo non è mai un punto d'arrivo**, ma solo l'occasione per accelerare ancora. E di questa adrenalina vedrà traccia in ogni pagina che seguirà, **un vero e proprio cambio di passo per Nobex**: l'espressione concreta di un'evoluzione, un tributo alla tecnica e un riferimento sicuro per ogni professionista.

L'ingresso di Nobex in Sistem Air Group non è stata un'operazione senz'anima, ma la naturale attrazione verso l'amore per la tecnica che contraddistingue il nostro Gruppo. Un investimento guidato da una visione chiara, per **offrire ai professionisti una certezza nel lavoro e affermarsi come un partner di fiducia al loro fianco**. Sistem Air Group, leader del settore in Europa, con una presenza capillare nei mercati internazionali, mette la sua esperienza e solidità industriale al servizio di un marchio storico, che da oltre trent'anni **rappresenta un'azienda di riferimento nella produzione dei sistemi di fissaggio**.

Questo catalogo è la prova tangibile e racconta dove vogliamo andare: soluzioni in grado di rispondere a tutte le esigenze di fissaggio, da quelle universali in nylon e metallo, fino alle applicazioni più specifiche, dove la capacità progettuale di Nobex fa la differenza. Ma non basta. **L'elevata qualità di prodotto**, alla base di ogni fase del processo, dall'ingegnerizzazione alla certificazione, trova adesso l'evoluzione nella competitività e nell'eccellenza tecnica di un grande Gruppo altamente specializzato.

Prima di tutto la sostanza. Nobex ha sempre avuto la tecnica cucita sulla pelle e oggi esprime liberamente tutto il suo potenziale con Sistem Air Group, che ha fatto della competenza e del servizio al professionista la propria missione. **Dietro ogni soluzione di fissaggio c'è una squadra di specialisti** che studia, progetta, realizza, collauda e garantisce che ogni prodotto sia non solo efficace ma il miglior strumento di lavoro possibile.

Perché quando si parla di fissaggio, non può e non dev'essere altrimenti.

Giancarlo Plebani
Fondatore e CEO di Sistem Air Group

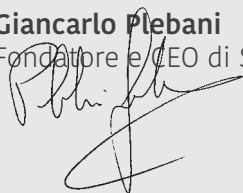

Nobex

Nobex è un brand di **Sistem Air Group** TecnoPlus Srl, azienda italiana leader nella produzione meccanica, soluzioni per il cleaning e realizzazione di progetti conto terzi.

Lavora acciaio, ferro e plastica per offrire al mercato infinite soluzioni. Una linea completa a 360°, che parte dalla progettazione e arriva al prodotto finito, distribuito attraverso la logistica integrata.

Nata nel 1993 a Gravellona Lomellina, oggi rappresenta **il più grande produttore europeo del settore**, presente stabilmente in oltre 54 paesi nel mondo.

Un global player internazionale riconosciuto per gli elevati standard di prodotto e servizio post vendita.

Progettazione & engineering

Idee all'avanguardia che anticipano i tempi, orientate a rispondere alle esigenze del mercato.

Partiamo dall'idea del prodotto, lo progettiamo, ingegnerizziamo e lo affidiamo all'esperienza dei nostri tecnici interni altamente specializzati.

Siamo un produttore completo, in grado di trasformare ogni progetto in realtà.





Produzione e logistica rappresentano la chiave del successo.



Dal cuore produttivo dell'Italia, i sistemi di fissaggio sono esportati in oltre 54 paesi nel mondo.





▶▶ Non penserai
ad altro

nobex.it

▶▶ Progettata per i professionisti

Una gamma unica per fare tutto

Nobex è il partner eletto dei professionisti che cercano soluzioni affidabili **senza compromessi**. Conosciamo le esigenze di chi lavora sul campo ogni giorno e sappiamo quanto sia importante poter contare su prodotti di qualità, **facili da scegliere e sempre disponibili**. Per questo, abbiamo una gamma completa in grado di rispondere con precisione a ogni necessità.

I prodotti nascono dall'ascolto attento delle reali esigenze del settore. Ogni soluzione è studiata per garantire performance elevate, sicurezza e durata nel tempo, perché sappiamo che il fissaggio giusto non è solo un dettaglio, ma un elemento chiave per il successo di ogni lavoro.

Nel catalogo Nobex il professionista trova tutto ciò di cui ha bisogno.
Con la certezza di scegliere soluzioni progettate per fare la differenza.





Certificazioni

Nobex è certificata secondo la **norme ISO 9001:2015** per i sistemi di qualità aziendali.

Garantiamo la **qualità del processo produttivo** dal controllo della materia prima fino allo stoccaggio finale del prodotto, con la possibilità di controllare la tracciabilità del lotto di produzione.











Legenda

La guida semplifica la lettura delle specifiche dei prodotti presenti a catalogo.

Si invita a scaricare la scheda tecnica del prodotto, **inquadrando il QR code** presente accanto a ogni articolo, per il download della documentazione completa.

Codice	Descrizione	Ø T mm	L1 mm	T/PIX mm	Scatola singola	Imballo complessivo
NB00000	Tassello	6	50	1	100 pz	5 Scatole
NB00001	Tassello	8	60	3	100 pz	5 Scatole





















Certificazioni e documentazioni

ETA - European Technical Approval Option 1 for cracked and uncracked concrete Option 7 for uncracked concrete	 
FM Approved	
VDS Schadenverhütung	
VDS CEA VDS CEA 4001:2008-11 (03) for applications of water extinguishing systems on concrete elements	
VOC CLASSIFICATION - Volatile Organic Compounds	
Certificazione antincendio	
EAD - European Assessment Document Test eseguiti secondo le direttive EAD di competenza presso il Dicar di Pavia	
Istituto Giordano Test eseguiti nel laboratorio di prova dell'Istituto Giordano	
Università di Pavia Test eseguiti presso il Dipartimento di Ingegneria civile e Architettura	
Scheda di sicurezza	



FISSAGGI PESANTI

MATERIALE DI SUPPORTO











	LINEA	APPLICAZIONI RACCOMANDATE	CALCESTRUZZO	PIETRA NATURALE	MATTONI PIENI	MATTONE CLS PIENO	CLS CELLULARE	LEGNO	MATTONI FORATI	MATTONE CLS FORATI	CARTONGESSO	MATERIALI ISOLANTI	PAG
	 TMC 7	Tassello in acciaio passante ad espansione omologato ETA Opzione 7 per calcestruzzo non fessurato idoneo per applicazioni su materiali compatti per carichi di elevata portata.											2
	 TMC 7 inox	Tassello in acciaio passante ad espansione omologato ETA Opzione 7 per calcestruzzo non fessurato idoneo per applicazioni su materiali compatti per carichi di elevata portata. Disponibile In inox A4.											3
	TM-FL	Tassello in acciaio passante ad espansione per calcestruzzo fessurato non fessurato idoneo per applicazioni su materiali compatti per carichi di elevata portata. Indicato per carpenteria pesante, strutture provvisionali, scaffalature industriali, tende da sole, ancoraggi di impianti di condizionamento ed elettrici, mensole, scale, binari per ascensori, strutture porta cavi, cancelli e inferriate, segnaletica stradale, arredo urbano, ecc. Disponibile in versione TMX INOX A2 e A4											4 S 190 B 198
	 TMX		5										
	 TM CS  	Tassello in acciaio passante ad espansione omologato ETA opzione 1 e categoria di prestazione sismica C1/C2 per calcestruzzo fessurato idoneo per applicazioni su materiali compatti per carichi di elevata portata. Indicato per carpenteria pesante, strutture provvisionali, scaffalature industriali, tende da sole, ancoraggi di impianti di condizionamento ed elettrici, mensole, scale, binari per ascensori, strutture porta cavi, cancelli e inferriate, segnaletica stradale, arredo urbano, ecc											6
	NX	Ancoraggio in acciaio non passante ad espansione idoneo per applicazioni su materiali compatti per carichi di forte portata. Indicato per Carpenteria pesante, strutture provvisionali, scaffalature metalliche, tende da sole, ancoraggi di impianti di condizionamento, idraulici ed elettrici, mensole, strutture porta-cavi, scale antincendio e di sicurezza macchinari, strutture per facciate ventilate, segnaletica stradale, profili, ecc...											8
	NX-B		8 B 199										
	NX-BF		9										
	NX-OA		9 B 199										
	NX-OC		9 B 199										
	NX-OCPS		10										
	 NX-OCS 23		Il tassello NX-OCS Ø 23 in acciaio passante ad espansione è adatto per essere impiegato su materiali compatti quali calcestruzzo, mattoni pieni e pietra naturale per carichi elevati. Indicato per elementi in sospensione, ancoraggi di strutture provvisionali.										10
	 NXX		Ancoraggio in acciaio non passante ad espansione idoneo per applicazioni su materiali compatti per carichi di forte portata. In acciaio inox A - aisi.										

= applicazione idonea

= previa verifica consistenza del materiale di base

S = secchiello

B = blister

LINEA	APPLICAZIONI RACCOMANDATE	CALCESTRUZZO	PIETRA NATURALE	MATTONI PIENI	MATTONE CLS PIENO	CLS CELLULARE	LEGNO	MATTONI FORATI	MATTONE CLS FORATI	CARTONGESSO	MATERIALI ISOLANTI	PAG	
 NXX-BX	Ancoraggio in acciaio non passante ad espansione idoneo per applicazioni su materiali compatti per carichi di elevata portata. In acciaio inox A - aisi 304 con bullone T.E. A2 e rondella inox.											11	
 HSP	Ancoraggio in acciaio non passante ad espansione per calcestruzzo non fessurato, idoneo per applicazioni su materiali compatti per carichi di forte portata. Indicati per carpenteria pesante, strutture provvisionali, scaffalature metalliche, tende da sole, ancoraggi di impianti di condizionamento, idraulici ed elettrici, mensole, strutture porta-cavi, scale antincendio e di sicurezza macchinari, strutture per facciate ventilate, segnaletica stradale, profili, ecc...											12	
 HSP-B												12	
 HSP-OA													13
 HSP-OC													13
 HPM	Ancoraggio in lega di Zamak non passante ad espansione, idoneo per applicazioni su materiali compatti per carichi di forte portata. Indicato per carpenteria pesante, strutture provvisionali, scaffalature metalliche, tende da sole, ancoraggi di impianti di condizionamento, idraulici ed elettrici, mensole, strutture porta-cavi, scale antincendio e di sicurezza macchinari, strutture per facciate ventilate, segnaletica stradale, profili.											14	
 HPM-B													14
 HPM-OA													15
 HPM-OC													15
 HPM-BX		Ancoraggio in lega di Zamak non passante ad espansione, idoneo per applicazioni su materiali compatti per carichi di forte portata. Con Bullone T.e. 8.8 e rondella in acciaio inox A2, a richiesta A4.											15
 SXP	Ancorante in acciaio non passante ad espansione a più settori, idoneo per applicazioni su materiali compatti per carichi di media portata , con bullone t.e. e rondella in inox A2, o richiesta A4.											16	

FISSAGGI PESANTI

MATERIALE DI SUPPORTO

LINEA	APPLICAZIONI RACCOMANDATE	CALCESTRUZZO	PIETRA NATURALE	MATTONI PIENI	MATTONE CLS PIENO	CLS CELLULARE	LEGNO	MATTONI FORATI	MATTONE CLS FORATI	CARTONGESSO	MATERIALI ISOLANTI	PAG
 SXPX-BX	Ancorante in acciaio non passante ad espansione a più settori, idoneo per applicazioni su materiali compatti per carichi di media portata. Con bullone t.e. e rondella in inox A2 o richiesta A4.											16
 SXP CE	Ancorante in acciaio non passante ad espansione, omologato ETA opzione 7 per calcestruzzo non fessurato a 3 settori di espansione idoneo per applicazioni su materiali compatti per carichi di media portata. Indicato per carpenteria pesante, strutture provvisionali, scaffalature metalliche, tende da sole, ancoraggi di impianti di condizionamento, idraulici ed elettrici, mensole, strutture porta-cavi, scale antincendio e di sicurezza, cancelli e inferriate, macchinari, strutture per facciate ventilate, segnaletica stradale, profili, ecc...											16
 SXP-B CE	Ancorante in acciaio non passante ad espansione, omologato ETA opzione 7 per calcestruzzo non fessurato a 3 settori di espansione idoneo per applicazioni su materiali compatti per carichi di media portata. Indicato per carpenteria pesante, strutture provvisionali, scaffalature metalliche, tende da sole, ancoraggi di impianti di condizionamento, idraulici ed elettrici, mensole, strutture porta-cavi, scale antincendio e di sicurezza, cancelli e inferriate, macchinari, strutture per facciate ventilate, segnaletica stradale, profili, ecc...											17
 SXPX CE	Ancorante in acciaio non passante ad espansione omologato ETA opzione 7 per calcestruzzo non fessurato a 3 settori di espansione idoneo per applicazioni su materiali compatti per carichi di media portata. In inox A4.											17
 SXPX-BX CE	Ancorante in acciaio, non passante ad espansione, omologato ETA opzione 7 per calcestruzzo non fessurato, a 3 settori di espansione, idoneo per applicazioni su materiali compatti per carichi di media portata. Con Bullone T.E e rondella inox A4.											17
 SXP												18
 SXP-B	Ancoraggio in acciaio non passante ad espansione, idoneo per applicazioni su materiali compatti per carichi di forte portata. Indicato per carpenteria pesante, strutture provvisionali, scaffalature metalliche, tende da sole, ancoraggi di impianti di condizionamento, idraulici ed elettrici, mensole, strutture porta-cavi, scale antincendio e di sicurezza macchinari, strutture per facciate ventilate, segnaletica stradale, profili, ecc...											18
 SXP-BF												19
 SXP-OA												19

= applicazione idonea



















= previa verifica consistenza del materiale di base

S = secchiello

B = blister









FISSAGGI PESANTI

MATERIALE DI SUPPORTO

LINEA	APPLICAZIONI RACCOMANDATE	CALCESTRUZZO	PIETRA NATURALE	MATTONI PIENI	MATTONI CLS PIENO	CLS CELLULARE	LEGNO	MATTONI FORATI	MATTONI CLS FORATI	CARTONGESSO	MATERIALI ISOLANTI	PAG	
 SXP-OC	Ancoraggio in acciaio non passante ad espansione, idoneo per applicazioni su materiali compatti per carichi di forte portata. Indicato per carpenteria pesante, strutture provvisorie, scaffalature metalliche, tende da sole, ancoraggi di impianti di condizionamento, idraulici ed elettrici, mensole, strutture porta-cavi, scale antincendio e di sicurezza macchinari, strutture per facciate ventilate, segnaletica stradale, profili, ecc...											19	
 SXP-SV												B 198	
 SXP-P													20
 SXP-TAPR													B 198
 SXC	Tassello in acciaio passante ad espansione, con dado cieco removibile, per applicazioni su materiali compatti per carichi di elevata portata											20	
 SKB	  Sismica Cat. C1-C2											22	
 SKB-BF	  Sismica Cat. C1-C2	Tassello in acciaio passante omologato ETA per calcestruzzo non fessurato, idoneo per parapetti, travi di acciaio macchine utensili, impianti industriali, costruzioni metalliche pesanti, blindosbarre, camminamenti sospesi e quadri elettrici industriali.										22	
 SKB-SV												23	
 SXB												23	
 SXB-BF		Tassello in acciaio passante certificato opzione 7 per calcestruzzo non fessurato, idoneo per parapetti, travi di acciaio, macchine utensili, impianti industriali costruzioni metalliche pesanti, blindosbarre, camminamenti sospesi e quadri elettrici industriali.										24	
 SXB-DC												24	
												25	

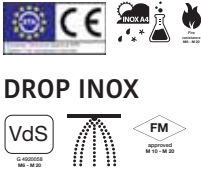
FISSAGGI PESANTI

MATERIALE DI SUPPORTO

LINEA	APPLICAZIONI RACCOMANDATE	CALCESTRUZZO	PIETRA NATURALE	MATTONI PIENI	MATTONE CLS PIENO	CLS CELLULARE	LEGNO	MATTONI FORATI	MATTONE CLS FORATI	CARTONGESSO	MATERIALI ISOLANTI	PAG
 DROP IN	Ancoraggio in acciaio non passante con filetto interno ad espansione tramite punzone, per calcestruzzo non fessurato, idoneo per applicazioni con carichi distanziati e/o di elementi in sospensione.											26
 DROP SF CE7 	Ancoraggio in acciaio non passante con filetto interno ad espansione tramite punzone omologato ETA in opzione 7, per calcestruzzo non fessurato, idoneo per applicazioni con carichi distanziati e/o di elementi in sospensione.											26
 DROP INOX 	Ancoraggio in acciaio non passante con filetto interno ad espansione tramite punzone omologato ETA in opzione 7, per calcestruzzo non fessurato, idoneo per applicazioni con carichi distanziati e/o di elementi in sospensione. In inox A4.											27
 Punzone	Attrezzo per per espandere il cono interno della gamma drop.											27
 NTO 	Ancoraggio in ottone non passante con filetto interno ad espansione, idoneo per fissaggi su materiali compatti per applicazioni con carichi distanziati e/o di elementi in sospensione.											27

B 199

FISSAGGI MEDIO PESANTI

MATERIALE DI SUPPORTO

LINEA	APPLICAZIONI RACCOMANDATE	CALCESTRUZZO	PIETRA NATURALE	MATTONI PIENI	MATTONE CLS PIENO	CLS CELLULARE	LEGNO	MATTONI FORATI	MATTONE CLS FORATI	CARTONGESSO	MATERIALI ISOLANTI	PAG
 SXL-V	Tassello in acciaio passante in lamierino, ad espansione, per applicazioni su materiali compatti e semicompatti per carichi di media portata. Indicati per carpenteria metallica, strutture provvisorie, scaffalature industriali, tende da sole, ancoraggi di impianti di condizionamento, idraulici ed elettrici, mensole, scale, binari per ascensori, strutture porta cavi, cancelli e inferriate, segnaletica stradale, arredo urbano, serramenti, ecc..											28
 SXL-OAF												

= applicazione idonea















= previa verifica consistenza del materiale di base

S = secchiello

B = blister







FISSAGGI MEDIO PESANTI

MATERIALE DI SUPPORTO

LINEA	APPLICAZIONI RACCOMANDATE	CALCESTRUZZO	PIETRA NATURALE	MATTONI PIENI	MATTONE CLS PIENO	CLS CELLULARE	LEGNO	MATTONI FORATI	MATTONE CLS FORATI	CARTONGESSO	MATERIALI ISOLANTI	PAG
 SXL-OCF	Tassello in acciaio passante in lamierino ad espansione, per applicazioni su materiali compatti e semicompatti per carichi di media portata. Indicati per carpenteria metallica, strutture provvisionali, scaffalature industriali, tende da sole, ancoraggi di impianti di condizionamento, idraulici ed elettrici, mensole, scale, binari per ascensori, strutture porta cavi, cancelli e inferriate, segnaletica stradale, arredo urbano, serramenti, ecc..											29
 SXLV-GL												29
 SXL-INV												
 DIBOLT con vite TE 6.8	Tassello in acciaio passante in lamiera ad espansione, per applicazioni su materiali compatti per carichi di media portata. Indicati per carpenteria metallica, strutture provvisionali, scaffalature industriali, tende da sole, ancoraggi di impianti di condizionamento, idraulici ed elettrici, mensole, scale, binari per ascensori, strutture porta cavi, cancelli e inferriate, segnaletica stradale, arredo urbano, serramenti, ecc.											29
 DIBOLT con vite TE 8.8												30
 DIBOLT-SV												31
 DIBOLT CE	 ETAG 001-02 per uso su calcestruzzo non fessurato (cen/TS 1992-4 Metodo A)	Tassello in acciaio passante certificato ETA Opzione 7 per calcestruzzo non fessurato in lamiera ad espansione per applicazioni su materiali compatti per carichi di media portata.										31
 SCB con testa esagonale flangiata	Vite in acciaio autofilettante parzialmente filettato, per fissaggi su materiali compatti per carichi di media portata. Indicata per carpenteria pesante, strutture provvisionali, scaffalature metalliche, tende da sole, ancoraggi di impianti di condizionamento, idraulici ed elettrici, mensole, strutture porta-cavi, scale antincendio e di sicurezza macchinari, strutture per facciate ventilate, segnaletica stradale, profili, ringhiere, corrimani, scale, ecc..											30
 SCB con testa esagonale												
 SCB CE	 											32
 AUT-C A	Vite in acciaio autofilettante per fissaggi su materiali compatti, con testa cilindrica Torx indicata per opere di carpenteria metallica.											33
 AUT-C B	Vite in acciaio autofilettante per fissaggi su materiali compatti, con testa conica Torx indicata per opere di carpenteria.											34

FISSAGGI UNIVERSALI

MATERIALE DI SUPPORTO

LINEA	APPLICAZIONI RACCOMANDATE	CALCESTRUZZO	PIETRA NATURALE	MATTONI PIENI	MATTONE CLS PIENO	CLS CELLULARE	LEGNO	MATTONI FORATI	MATTONE CLS FORATI	CARTONGESSO	MATERIALI ISOLANTI	PAG	
 <p>EMC² Ø6-Ø8</p>	Tassello universale bi-materiale con doppio bordo e avanzato sistema anti rotazione, idoneo per fissaggio di carichi medio leggeri su materiali compatti, semicompatti, forati, pannelli e lastre in cartongesso, tufo e gasbeton.											39 S 184	
 <p>NC</p>	Ancorante universale in nylon multiespansione, idoneo per materiali compatti, semicompatti, forati, pannelli e lastre in cartongesso. Indicato per fissaggio di lampade, guide per tende e riloghe, piccoli pensili e armadietti, carpenteria leggera, interruttori e quadri elettrici, cassette portalettere, ecc...											40 S 184 B 191	
 <p>NCV</p>											41 S 184 B 192		
 <p>NCV-TL</p>												42 S 185	
 <p>NCV-TC</p>												42	
 <p>NCV-TE</p>												42 B 192	
 <p>NC-6</p>													43

= applicazione idonea









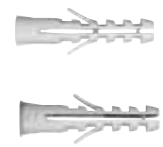

= previa verifica consistenza del materiale di base

S = secchiello

B = blister

FISSAGGI UNIVERSALI

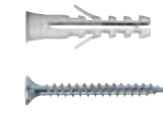
MATERIALE DI SUPPORTO

LINEA	APPLICAZIONI RACCOMANDATE	CALCESTRUZZO	PIETRA NATURALE	MATTONI PIENI	MATTONI CLS PIENO	CLS CELLULARE	LEGNO	MATTONI FORATI	MATTONI CLS FORATI	CARTONGESSO	MATERIALI ISOLANTI	PAG	
 <p>NCV plastic bag</p>	<p>Ancorante universale in nylon multiespansione, idoneo per materiali compatti, semicompatti, forati, pannelli e lastre in cartongesso. Indicato per fissaggio di lampade, guide per tende e riloghe, piccoli pensili e armadietti, carpenteria leggera, interruttori e quadri elettrici, cassette portalettere, ecc...</p>											41	
 <p>NCV small bag</p>													41
 <p>A - AB Eltex</p>													43
 <p>A</p>													44
													S 185 B 190
 <p>AB</p>													45
													S 186
 <p>AV-TC</p>	<p>Ancorante universale in nylon ad espansione con e senza bordo, idoneo per materiali compatti, semicompatti, forati, per carichi medio leggeri. Indicati per fissaggio di lampade, guide per tende e riloghe, piccoli pensili e armadietti, carpenteria leggera, interruttori e quadri elettrici, cassette portalettere, piccoli quadri e oggetti a parete, ecc...</p>											46	
 <p>AVB-TC</p>													S 185 B 190 B 191
													46
													S 186 B 191
 <p>AV-TE</p>													47
													B 191
 <p>KIT AVB-TC</p>													47
 <p>AQ</p>													47
													B 193









FISSAGGI UNIVERSALI LEGGERI

MATERIALE DI SUPPORTO

LINEA	APPLICAZIONI RACCOMANDATE	CALCESTRUZZO	PIETRA NATURALE	MATTONI PIENI	MATTONE CLS PIENO	CLS CELLULARE	LEGNO	MATTONI FORATI	MATTONE CLS FORATI	CARTONGESSO	MATERIALI ISOLANTI	PAG
 TOP-CB in polipropilene	Ancorante universale in polipropilene con e senza bordo, multiespansione, idoneo per materiali compatti, semi compatti e forati, per carichi medio leggeri. Indicato per fissaggio di lampade, guide per tende e riloghe, piccoli pensili e armadietti, carpenteria leggera, interruttori e quadri elettrici, cassette portalettere, piccoli quadri e oggetti a parete, ecc...											48
 TOP-V CB in polipropilene												
 TFN in nylon	Ancorante universale in nylon ad espansione, con bordo, idoneo per materiali compatti, semi compatti, forati, pannelli e lastre per carichi medio leggeri. Indicato per fissaggio di lampade, guide per tende e riloghe, piccoli pensili e armadietti, carpenteria leggera, interruttori e quadri elettrici, cassette portalettere, piccoli quadri e oggetti a parete, ecc...											49
 TFN-V in nylon												
												B 192

FISSAGGI UNIVERSALI

MATERIALE DI SUPPORTO

LINEA	APPLICAZIONI RACCOMANDATE	CALCESTRUZZO	PIETRA NATURALE	MATTONI PIENI	MATTONE CLS PIENO	CLS CELLULARE	LEGNO	MATTONI FORATI	MATTONE CLS FORATI	CARTONGESSO	MATERIALI ISOLANTI	PAG	
 TOP FUN-V	Ancoranti in nylon ad espansione controllata, idonei per fissaggi su materiali compatti semi compatti e forati indicato per installazioni distanziate per carichi medio leggeri. Fissaggio di lampade, pensili, quadri, impianti di antifurto, assi di legno, interruttori, accessori bagno, armadietti a muro, tende e riloghe, ecc.,											50	
 TOP FUN-GC													S 184 B 194
 TOP FUN-GM													50
 TOP FUN-GL													S 186 B 194
 TOP FUN-OA													50
 TOP FUN-OC													S 187 B 194
 TOP FUN-OC													51
 TOP FUN-DD													S 187 B 195
												51	
												S 187 B 195	
												51	
												B 195	

= applicazione idonea





= previa verifica consistenza del materiale di base

S = secchiello

B = blister

FISSAGGI UNIVERSALI PROLUNGATI

MATERIALE DI SUPPORTO

LINEA	APPLICAZIONI RACCOMANDATE	CALCESTRUZZO	PIETRA NATURALE	MATTONI PIENI	MATTONE CLS PIENO	CLS CELLULARE	LEGNO	MATTONI FORATI	MATTONE CLS FORATI	CARTONGESSO	MATERIALI ISOLANTI	PAG	
 TOP FUNP-V	Ancorante universale prolungato in nylon e acciaio, ad espansione controllata, completo di rondella e pitoneria premontata, idoneo per fissaggi di media portata. Indicato per il fissaggio di pensili, lampade, quadri, accessori bagno, armadietti da muro, cassette portalettere, tende, accessori per tende, ecc..											52	
 TOP FUNP-GC													52
 TOP FUNP-GM													52
 TOP FUNP-OA													53
 TOP FUNP-OC													53

PARACOLPI PER PORTE

MATERIALE DI SUPPORTO

LINEA	APPLICAZIONI RACCOMANDATE	CALCESTRUZZO	PIETRA NATURALE	MATTONI PIENI	MATTONE CLS PIENO	CLS CELLULARE	LEGNO	MATTONI FORATI	MATTONE CLS FORATI	CARTONGESSO	MATERIALI ISOLANTI	PAG
 FP 9	Ancorante universale prolungato in nylon e acciaio, ad espansione controllata, con tampone fermaporta.											53
												B 195

FISSAGGI UNIVERSALI MEDIO LEGGERI

MATERIALE DI SUPPORTO

LINEA	APPLICAZIONI RACCOMANDATE	CALCESTRUZZO	PIETRA NATURALE	MATTONI PIENI	MATTONE CLS PIENO	CLS CELLULARE	LEGNO	MATTONI FORATI	MATTONE CLS FORATI	CARTONGESSO	MATERIALI ISOLANTI	PAG
 NNB	Ancorante in nylon ad espansione, di tipo passante, idoneo per fissaggi su materiali compatti, semi compatti e forati, per carichi medio leggeri. Indicato per fissaggio di scaldabagni, caldaie, pensili, impianti, accessori bagno, armadietti a muro, mensole a scomparsa, serramenti, cancellate, ringhiere, inferriate, arredo da giardino, segnaletica stradale, gazebo, ecc...											54
 NNBB												
 NNB-CG	Ancorante per fissaggio di scaldabagni e caldaie.											54









REGGIMENSOLA A SCOMPARSA

MATERIALE DI SUPPORTO

LINEA	APPLICAZIONI RACCOMANDATE	CALCESTRUZZO	PIETRA NATURALE	MATTONI PIENI	MATTONE CLS PIENO	CLS CELLULARE	LEGNO	MATTONI FORATI	MATTONE CLS FORATO	CARTONGESSO	MATERIALI ISOLANTI	PAG
 <p>RG-S</p>	Reggimensola a scomparsa con tassello per pareti semi compatte.											55

FISSAGGI UNIVERSALI

MATERIALE DI SUPPORTO

LINEA	APPLICAZIONI RACCOMANDATE	CALCESTRUZZO	PIETRA NATURALE	MATTONI PIENI	MATTONE CLS PIENO	CLS CELLULARE	LEGNO	MATTONI FORATI	MATTONE CLS FORATO	CARTONGESSO	MATERIALI ISOLANTI	PAG
 <p>TSP</p>	<p>Ancorante in nylon con espansione elicoidale, ideale per cartongesso e pareti vuote, per carichi medi. Indicato per il fissaggio di pensili, lampade, quadri , accessori bagno, armadietti, tende ecc.</p>											56
 <p>TSP-T</p>												56
 <p>TSP-P</p>												57
 <p>TSP-GM</p>												57
 <p>TSP-SV</p>												58
 <p>TSP-TP</p>												58
 <p>TSP-OA</p>												59
 <p>TSP-OC</p>												59

= applicazione idonea











= previa verifica consistenza del materiale di base

S = secchiello



B = blister

FISSAGGI UNIVERSALI IN ACCIAIO

MATERIALE DI SUPPORTO

LINEA	APPLICAZIONI RACCOMANDATE	CALCESTRUZZO	PIETRA NATURALE	MATTONI PIENI	MATTONE CLS PIENO	CLS CELLULARE	LEGNO	MATTONI FORATI	MATTONE CLS FORATO	CARTONGESSO	MATERIALI ISOLANTI	PAG	
 FUA-V	Ancoranti in acciaio ad espansione, idonei per fissaggi su materiali compatti, per installazioni distanziate per carichi medio leggeri. Indicato per il fissaggio di lampade, pensili, quadri, impianti di antifurto, assi di legno, interruttori, accessori bagno, armadietti a muro, tende e riloghe, ecc.											60 S 187 B 196	
 FUA-GC													60 S 187 B 196
 FUA-GM													60 S 188 B 196
 FUA-GL													61
 FUA-OA													61 S 188 B 196
 FUA-OC													61 B 196
 FUA-DD													62 B 196
 FUA-DDC													62
 AC-V MINI BULK MINI V	Ancoranti in acciaio mini, ad espansione, idonei per fissaggi su materiali compatti per carichi leggeri. Indicato per il fissaggio di lampade, quadri, impianti di antifurto, assi di legno, interruttori, accessori bagno, armadietti a muro, tende e riloghe, ecc.,											63 B 195	
 AC-G MINI BULK MINI G													63 B 195
 AC-O MINI BULK MINI O													63 B 195

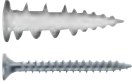

FISSAGGI PER CARTONGESSO
MATERIALE DI SUPPORTO

	LINEA	APPLICAZIONI RACCOMANDATE	CALCESTRUZZO	PIETRA NATURALE	MATTONI PIENI	MATTONE CLS PIENO	CLS CELLULARE	LEGNO	MATTONI FORATI	MATTONE CLS FORATO	CARTONGESSO	MATERIALI ISOLANTI	PAG
	SPV	Ancorante in nylon autopercorante di tipo non passante, idoneo per cartongesso per carichi leggeri.											64 B 197
	SPZ	Ancorante in Zamak autopercorante di tipo non passante, idoneo per cartongesso per carichi leggeri.											64 B 197



FISSAGGI PER CONTROSOFFITTI
MATERIALE DI SUPPORTO

	LINEA	APPLICAZIONI RACCOMANDATE	CALCESTRUZZO	PIETRA NATURALE	MATTONI PIENI	MATTONE CLS PIENO	CLS CELLULARE	LEGNO	MATTONI FORATI	MATTONE CLS FORATO	CARTONGESSO	MATERIALI ISOLANTI	PAG
	TC	Ancorante in acciaio per installazioni distanziate di pendinature per controsoffitti sia rigidi che flessibili, su materiali compatti.											64

VITI AUTOPERFORANTI E AUTOFILETTANTI
MATERIALE DI SUPPORTO

	LINEA	APPLICAZIONI RACCOMANDATE	CALCESTRUZZO	PIETRA NATURALE	MATTONI PIENI	MATTONE CLS PIENO	CLS CELLULARE	LEGNO	MATTONI FORATI	MATTONE CLS FORATO	CARTONGESSO	MATERIALI ISOLANTI	PAG
	V-ATL P.C.	Vite zincata, autofilettante, testa larga Philips PH2, punta a chiodo.											65
	V-ATL P.T.	Vite zincata, autofilettante, testa larga Philips PH2, punta a trapano.											65

VITI FOSFATE
MATERIALE DI SUPPORTO

	LINEA	APPLICAZIONI RACCOMANDATE	CALCESTRUZZO	PIETRA NATURALE	MATTONI PIENI	MATTONE CLS PIENO	CLS CELLULARE	LEGNO	MATTONI FORATI	MATTONE CLS FORATO	CARTONGESSO	MATERIALI ISOLANTI	PAG
	V-FOSF Punta a chiodo	Vite fosfatata, autofilettante, testa cono Philips PH2 punta a chiodo.											65 B 197
	V-FOSF punta a trapano	Vite fosfatata, autofilettante, testa cono Philips PH2 punta a trapano.											65

= applicazione idonea



= previa verifica consistenza del materiale di base

S = secchiello

B = blister





FISSAGGI PER PARETI VUOTE E CARTONGESSO

MATERIALE DI SUPPORTO

LINEA	APPLICAZIONI RACCOMANDATE	CALCESTRUZZO	PIETRA NATURALE	MATTONI PIENI	MATTONI CLS PIENO	CLS CELLULARE	LEGNO	MATTONI FORATI	MATTONI CLS FORATO	CARTONGESSO	MATERIALI ISOLANTI	PAG
 HAV	Ancorante in nylon di tipo non passante idoneo per cartongesso e pareti vuote, per carichi leggeri.											66
 HAV-V con vite truciolare												66 B 197

FISSAGGI PER PARETI VUOTE E CARTONGESSO

MATERIALE DI SUPPORTO

LINEA	APPLICAZIONI RACCOMANDATE	CALCESTRUZZO	PIETRA NATURALE	MATTONI PIENI	MATTONI CLS PIENO	CLS CELLULARE	LEGNO	MATTONI FORATI	MATTONI CLS FORATO	CARTONGESSO	MATERIALI ISOLANTI	PAG	
 TUBE-FIX	Sistema di fissaggio di tubi per installazione su muratura piena, forata e cartongesso, tramite apposito adattatore.											67	
 GRAP-FIX singolo												67	
 GRAP-FIX doppio													67
 CLIP-FIX													67

FISSAGGI IN ACCIAIO PER CONTROSOFFITTI, CARTONGESSO E CALCESTRUZZO CELLULARE







MATERIALE DI SUPPORTO

LINEA	APPLICAZIONI RACCOMANDATE	CALCESTRUZZO	PIETRA NATURALE	MATTONI PIENI	MATTONI CLS PIENO	CLS CELLULARE	LEGNO	MATTONI FORATI	MATTONI CLS FORATO	CARTONGESSO	MATERIALI ISOLANTI	PAG
 CPV	Ancorante in acciaio di tipo non passante, ad espansione, idoneo per il fissaggio di carichi leggeri su pannelli in cartongesso.											68
 CPV-B												68
 PINZE	Pinza per montaggio CPV.											68

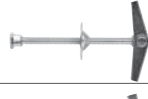
FISSAGGI RAPIDI IN NYLON
MATERIALE DI SUPPORTO

LINEA	APPLICAZIONI RACCOMANDATE	CALCESTRUZZO	PIETRA NATURALE	MATTONI PIENI	MATTONI CLS PIENO	CLS CELLULARE	LEGNO	MATTONI FORATI	MATTONI CLS FORATO	CARTONGESSO	MATERIALI ISOLANTI	PAG
 TNSM-RE	Tassello in nylon con vite premontata, rapido a battuta, ad installazione controllata di tipo passante. Ideale per coperture, infissi e impiantistica.											69
 TNB	Tasselli in nylon con vite premontata, rapidi a battuta, ad installazione controllata di tipo passante. Indicato per fissaggio di lamiere, scossaline, profili per cartongesso, listelli in legno, infissi, canaline a parete, impianti elettrici ed idraulici, pluviali, ecc.											69
 NGB	Ancorante in nylon, con serraggio a esagono incassato ideale per calcestruzzo cellulare.											69

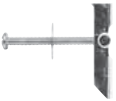
FISSAGGI PER ANCORE E BASCULANTI
MATERIALE DI SUPPORTO

LINEA	APPLICAZIONI RACCOMANDATE	CALCESTRUZZO	PIETRA NATURALE	MATTONI PIENI	MATTONI CLS PIENO	CLS CELLULARE	LEGNO	MATTONI FORATI	MATTONI CLS FORATO	CARTONGESSO	MATERIALI ISOLANTI	PAG
 AK-V	Ancorine con molla in acciaio zincato, per un fissaggio stabile, per montaggi di elementi leggeri. Vite e rondella.											70 S 187 B 194
 AK-DC	Ancorine con molla in acciaio zincato, per un fissaggio stabile, per montaggi di elementi leggeri. Dado cieco.											70 B 194
 AK-DD	Ancorine con molla in acciaio zincato, per un fissaggio stabile, per montaggi di elementi leggeri. Barra filettata, rondella e doppio dado.											70 S 189
 AK-OA	Ancorine con molla in acciaio zincato, per un fissaggio stabile, per montaggi di elementi leggeri. Occhio aperto.											71 S 189 B 194
 AK-OC	Ancorine con molla in acciaio zincato, per un fissaggio stabile, per montaggi di elementi leggeri. Occhio chiuso.											71 S 190 B 194
 AK-R	Ricambio ancorina con nottolino piatto.											71
 BK-V	Bascula con molla in acciaio zincato, per un fissaggio stabile, per montaggi di elementi leggeri. Vite e rondella.											72
 BK-DD	Bascula con molla in acciaio zincato, per un fissaggio stabile, per montaggi di elementi leggeri. Barra filettata, rondella e doppio dado.											72



= applicazione idonea

= previa verifica consistenza del materiale di base

S = secchiello











B = blister

FISSAGGI PER ANCORE E BASCULANTI

LINEA	APPLICAZIONI RACCOMANDATE	CALCESTRUZZO	PIETRA NATURALE	MATTONI PIENI	MATTONI CLS PIENO	CLS CELLULARE	LEGNO	MATTONI FORATI	MATTONI CLS FORATO	CARTONGESSO	MATERIALI ISOLANTI	PAG
 BK-OC	Bascula con molla in acciaio zincato, per un fissaggio stabile, per montaggi di elementi leggeri. Occhiolo aperto.											72
 BK-OA	Bascula con molla in acciaio zincato, per un fissaggio stabile, per montaggi di elementi leggeri. Occhiolo chiuso.											73
 BK-R	Ricambio bascula.											73

MATERIALE DI SUPPORTO











FISSAGGI PROLUNGATI PER SERRAMENTI

LINEA	APPLICAZIONI RACCOMANDATE	CALCESTRUZZO	PIETRA NATURALE	MATTONI PIENI	MATTONI CLS PIENO	CLS CELLULARE	LEGNO	MATTONI FORATI	MATTONI CLS FORATO	CARTONGESSO	MATERIALI ISOLANTI	PAG	
 NC-PS V	Tassello in nylon NC-PS di tipo passante, per fissaggi prolungati con particolare geometria del corpo, espandente a 4 settori, che consente un'espansione differenziata a seconda del tipo di materiale di posa in opera. Indicato per fissaggi di profili, serramenti, coperture in legno e in acciaio, listelli di legno, controtelai, pareti ventilate, etc...											74	
 NC-PS T												74	
 NC-PS TE													75
 NC-PS TEF													75
 NC-PS VTS													75
 NC-L	Tassello in nylon NC-XL di tipo passante, per fissaggi prolungati con particolare geometria del corpo, espandente a 4 settori, che consente un'espansione differenziata a seconda del tipo di materiale di posa in opera. Indicato per fissaggi di profili, serramenti, coperture in legno e in acciaio, listelli di legno, controtelai, pareti ventilate, etc...											76	
 NC-XL													76
 NC-XL V													76
 NC-XL T													77
 NC-XL TE													77

MATERIALE DI SUPPORTO

FISSAGGI PROLUNGATI PER SERRAMENTI

MATERIALE DI SUPPORTO

LINEA	APPLICAZIONI RACCOMANDATE	CALCESTRUZZO	PIETRA NATURALE	MATTONI PIENI	MATTONE CLS PIENO	CLS CELLULARE	LEGNO	MATTONI FORATI	MATTONE CLS FORATO	CARTONGESSO	MATERIALI ISOLANTI	PAG
 AF	Ancorante in nylon ad espansione, passante, con vite premontata, idoneo per il fissaggio dei serramenti su materiali compatti, semi compatti e forati, per carichi medio leggeri. Indicato per fissaggio di profili per serramenti in alluminio, legno, pvc, finestre e porte finestre, infissi, telai, sottostrutture di tetti, cancellate, ecc..											78
 TNAP	Ancorante universale passante in nylon, con bordo, idoneo per materiali compatti, semicompatti e forati, per carichi medio leggeri. Indicato per fissaggio di listelli in legno, tubi metallici, lampade, guide per tende e riloghe, coperture, profili di serramenti, infissi, accessori elettrici, grate, cordoli stradali, carpenteria leggera, ecc...											78
 TNAP-V												79
 TNAP-T												79
 TNAP-TE												80
 TNAP-VTS												80
 TNSV		Ancorante universale passante in nylon con bordo, idoneo per materiali compatti, semicompatti e forati, per carichi medio leggeri. Indicato per fissaggio di listelli in legno, tubi metallici, lampade, guide per tende e riloghe, coperture, profili di serramenti, accessori elettrici, carpenteria leggera, ecc...										
 ABP ABP 14-3 alette	Ancorante universale passante in nylon con bordo, idoneo per materiali compatti, semicompatti e forati, per carichi medio leggeri. Indicato per fissaggio di listelli in legno, tubi metallici, lampade, guide per tende e riloghe, coperture, profili di serramenti, accessori elettrici, carpenteria leggera, ecc...											82
 ABP TR ABP 16-4 alette												82
 ABP TR ABP 14-3 alette												

= applicazione idonea



= previa verifica consistenza del materiale di base

S = secchiello

B = blister

FISSAGGI PROLUNGATI PER SERRAMENTI

MATERIALE DI SUPPORTO







LINEA	APPLICAZIONI RACCOMANDATE	CALCESTRUZZO	PIETRA NATURALE	MATTONI PIENI	MATTONE CLS PIENO	CLS CELLULARE	LEGNO	MATTONI FORATI	MATTONE CLS FORATO	CARTONGESSO	MATERIALI ISOLANTI	PAG
 ABP TRF	Ancorante universale passante in nylon, multisetto con bordo e vite, con zincatura flakes, idoneo per carichi medi. Indicato per fissaggio di listelli in legno, tubi metallici, lampade, guide per tende e riloghe, coperture, profili di serramenti, accessori elettrici, carpenteria leggera, ecc...											83
 AB PROL	Ancorante universale passante in nylon, con bordo, idoneo per materiali compatti, semicompatti e forati, per carichi medio leggeri. Indicato per fissaggio di listelli in legno, tubi metallici, lampade, guide per tende e riloghe, coperture, profili di serramenti, accessori elettrici, carpenteria leggera, ecc...											83
 ABTR												83

FISSAGGI RAPIDI A BATTUTA



MATERIALE DI SUPPORTO

LINEA	APPLICAZIONI RACCOMANDATE	CALCESTRUZZO	PIETRA NATURALE	MATTONI PIENI	MATTONE CLS PIENO	CLS CELLULARE	LEGNO	MATTONI FORATI	MATTONE CLS FORATO	CARTONGESSO	MATERIALI ISOLANTI	PAG	
 TNSM-RE	Tassello in nylon con vite premontata, rapido, a battuta, ad installazione controllata di tipo passante. Indicato per fissaggio di coperture, listelli in legno, infissi, telai e controtelai, profili, canaline a parete, impianti elettrici ed idraulici, pluviali, ecc Disponibili in versione con vite INOX											84	
 TNSM-SV												85 S 188 B 193	
 TNSMX-RE												86	
 TNSMX-SV												86	
 TNB												87 S 189 B 194	
 TNB-VTX													87
 TNA-FIL		Tassello in nylon con perno a testa filettata. Indicato per il montaggio di collari.											87

FISSAGGI RAPIDI A BATTUTA
MATERIALE DI SUPPORTO

LINEA	APPLICAZIONI RACCOMANDATE	CALCESTRUZZO	PIETRA NATURALE	MATTONI PIENI	MATTONE CLS PIENO	CLS CELLULARE	LEGNO	MATTONI FORATI	MATTONE CLS FORATO	CARTONGESSO	MATERIALI ISOLANTI	PAG
 TNB-RX	Tasselli in nylon con vite premontata, rapidi , a battuta ad installazione controllata di tipo passante. Indicato per fissaggio di lamiere, scossaline, profili per cartongesso, listelli in legno, infissi, canaline a parete, impianti elettrici ed idraulici, pluviali, ecc.											88
 TNB-RR												88
 TNB-TRL												88
 TNB-TM												89
 TNB-TMR												89
 TZB	Tassello in Zamak di tipo passante con chiodo premontato in acciaio, con installazione a battuta. Indicato per fissaggio di lamiere, scossaline, cartellonistica, listelli in legno, infissi, carpenteria leggera, ecc.											89

FISSAGGI RAPIDI A BATTUTA ETICS PER ISOLAMENTO
MATERIALE DI SUPPORTO

LINEA	APPLICAZIONI RACCOMANDATE	CALCESTRUZZO	PIETRA NATURALE	MATTONI PIENI	MATTONE CLS PIENO	CLS CELLULARE	LEGNO	MATTONI FORATI	MATTONE CLS FORATO	CARTONGESSO	MATERIALI ISOLANTI	PAG
  ISO	Tassello in polipropilene bianco con chiodo percussore, in poliammide rinforzato con fibra di vetro, di tipo passante a battuta, idoneo per il fissaggio di materiali isolanti sia rigidi sia morbidi, su materiali compatti e semicompatti. Per applicazioni su materiali isolanti in polistirene, polistirolo, lana di vetro, lana di roccia, ecc...											92
 ISO-L	Tassello in polipropilene con perno in poliammide, di tipo passante a battuta, specifico per la messa in opera di sistemi di isolamento (ETICS) polistirolo, polistirene, lana di vetro, lana di roccia, materiali isolanti soffici.											92
 ISO-P	Tassello in polipropilene additivato, a battuta, specifico per pannelli isolanti rigidi.											92
  ISO-S CE	Tassello in poliammide con perno in acciaio o poliammide omologato secondo l'ETAG 014 di tipo passante a battuta, utilizzato per la messa in opera di sistemi per isolamento a cappotto (ETICS) poliuretano rigido, polistirolo, polistirene estruso, vetro cellulare, lana minerale, materiali isolanti resistenti a compressione.											93

= applicazione idonea

= previa verifica consistenza del materiale di base

S = secchiello

B = blister





RONDELLE ETICS PER ISOLAMENTO

MATERIALE DI SUPPORTO

LINEA	APPLICAZIONI RACCOMANDATE	CALCESTRUZZO	PIETRA NATURALE	MATTONI PIENI	MATTONE CLS PIENO	CLS CELLULARE	LEGNO	MATTONI FORATI	MATTONE CLS FORATO	CARTONGESSO	MATERIALI ISOLANTI	PAG
 <p>RP-I per ISO</p>	Rondelle in nylon da applicare a tassello ISO, con diametro maggiorato, per il fissaggio di materiali isolanti morbidi.											94
 <p>RP-T</p>	Rondelle in nylon da applicare a tassello ISO, con diametro maggiorato, per il fissaggio di materiali isolanti morbidi.											94

FISSAGGI A VITE ETICS PER ISOLAMENTO

MATERIALE DI SUPPORTO









LINEA	APPLICAZIONI RACCOMANDATE	CALCESTRUZZO	PIETRA NATURALE	MATTONI PIENI	MATTONE CLS PIENO	CLS CELLULARE	LEGNO	MATTONI FORATI	MATTONE CLS FORATO	CARTONGESSO	MATERIALI ISOLANTI	PAG
  <p>ISO-ST</p>	Tassello in Poliammide omologato con perno in acciaio, ad avvitamento, utilizzato per la messa in opera di sistemi di isolamento a cappotto (ETICS). Con fissaggio a vite, per evitare di danneggiare il supporto. Indicato per tutti i supporti specialmente schiuma di polistirolo e lana minerale.											95
  <p>ISO-ECO</p>	Tassello in poliammide rinforzato fibra di vetro con vite in acciaio, impronta Torx, include disco in lana minerale. Indicato per sistemi di isolamento su legno, pannelli a base legno e tavole in fibramento.											95

ACCESSORI ETICS PER ISOLAMENTO



MATERIALE DI SUPPORTO

LINEA	APPLICAZIONI RACCOMANDATE	CALCESTRUZZO	PIETRA NATURALE	MATTONI PIENI	MATTONE CLS PIENO	CLS CELLULARE	LEGNO	MATTONI FORATI	MATTONE CLS FORATO	CARTONGESSO	MATERIALI ISOLANTI	PAG
 <p>NPL</p>	Tassello in nylon con serraggio a esagono incassato, per fissaggio su cappotto.											96
  <p>ISO-D</p>	Tassello in acciaio ad applicazione chimica, per fissaggio su muri con cappotto termico, di cardini, fermaimposte pensiline, tende solari, grondaie, pluviali e pannelli leggeri.											96

FISSAGGI IDRO TERMO SANITARI
MATERIALE DI SUPPORTO

LINEA	APPLICAZIONI RACCOMANDATE	CALCESTRUZZO	PIETRA NATURALE	MATTONI PIENI	MATTONE CLS PIENO	CLS CELLULARE	LEGNO	MATTONI FORATI	MATTONE CLS FORATO	CARTONGESSO	MATERIALI ISOLANTI	PAG
 WC	Fissaggio VERTICALE WC e BIDET con dado in ottone nichelato.											100
 WC 2	Fissaggio LATERALE WC e BIDET MULTIFORO in nylon											100
 FL	Fissaggio per CASSETTA A PARETE con dado in acciaio e rondella in nylon.											101
 NNB-FL	Fissaggio per LAVABO con tassello a doppia espansione e dado in acciaio.											101
 FCS	Fissaggio SCALDABAGNO e CALDAIA tassello in nylon.											101
 NNB-CG	Fissaggio SCALDABAGNO e CALDAIA tassello in nylon con dado in acciaio.											102
 SXLV-GL	Fissaggio SCALDABAGNO e CALDAIA tassello in acciaio											102
 NCV-TE	Ancorante universale in nylon multiespansione idoneo per materiali compatti, semicompatti, forati, pannelli e lastre in cartongesso. Indicato per fissaggio di lampade, guide per tende e riloghe, piccoli pensili e armadietti, carpenteria leggera, interruttori e quadri elettrici, cassette portalettere. Con tirafondo.											102

COLLARI IN ACCIAIO PER TUBI PLUVIALI E FUMI
MATERIALE DI SUPPORTO

LINEA	APPLICAZIONI RACCOMANDATE	CALCESTRUZZO	PIETRA NATURALE	MATTONI PIENI	MATTONE CLS PIENO	CLS CELLULARE	LEGNO	MATTONI FORATI	MATTONE CLS FORATO	CARTONGESSO	MATERIALI ISOLANTI	PAG
 CF-KIT	Collare fermatubo con vite e tassello in nylon.											103
 CF												103

= applicazione idonea









= previa verifica consistenza del materiale di base

S = secchiello







B = blister

COLLARI IN ACCIAIO PER TUBI PLUVIALI E FUMI





MATERIALE DI SUPPORTO

LINEA	APPLICAZIONI RACCOMANDATE	CALCESTRUZZO	PIETRA NATURALE	MATTONI PIENI	MATTONE CLS PIENO	CLS CELLULARE	LEGNO	MATTONI FORATI	MATTONE CLS FORATO	CARTONGESSO	MATERIALI ISOLANTI	PAG
 CF-PVC	Collari fermatubo per tubi in pvc.											104
 CFC-PVC	Collare fermatubo per tubi in PVC con vite di giunzione e tassello in nylon											104
 CFX A2	Collari fermatubo in acciaio inox A2.											105
 CFX-C A2	Collari fermatubo in acciaio inox A2 con vite aisi 304 e tassello in nylon.											105
 CF-ISO	Collare per tubo con gomma epdm.											106
 CP	Collari zincati per tubo pluviale con vite e tassello in nylon.											106
 CP-TMRO	Collari testa di moro per tubo pluviale con vite e tassello in nylon.											107
 CP-RA	Collari rame per tubo pluviale con vite e tassello in nylon.											107
 CP-X	Collari in lamiera per tubo pluviale con vite e tassello in nylon.											107
 CF-RX	Collari in inox per fumi verniciato e regolabile.											108
 CL-R	Collari in rame, con vite di giunzione M6.											108
 CL-R BAG	Collari in rame, con vite di giunzione M6 e tassello in nylon.											109
 CL	Collare M6 per elettricisti e idraulici.											109
 CL - V	Collare M6 per elettricisti e idraulici con vite giunzione per collari e tassello in nylon.											110

FISSAGGI IDRAULICI ED ELETTRICI CAVALLOTTI

		LINEA	APPLICAZIONI RACCOMANDATE	PAG
		CV	Cavallotti labbro singolo.	111
		CVD	Cavallotti labbro doppio.	111
		CVP	Cavallotti pesanti labbro singolo.	112
		CAV	Cavallotti zincati filo tondo con dadi e rondelle per ancoraggio tubi.	112





VITI DI GIUNZIONE
MATERIALE DI SUPPORTO

LINEA	APPLICAZIONI RACCOMANDATE	CALCESTRUZZO	PIETRA NATURALE	MATTONI PIENI	MATTONE CLS PIENO	CLS CELLULARE	LEGNO	MATTONI FORATI	MATTONE CLS FORATO	CARTONGESSO	MATERIALI ISOLANTI	PAG
 VCG	Vite di giunzione doppio passo metrico / legno.											113
 VCG-A	Vite di giunzione doppio passo metrico / legno con tassello in nylon.											113
 VIS	Vite di giunzione doppio passo metrico / legno per collari.											114
 VIS-AB												114
 VIS-NC												114







= applicazione idonea

= previa verifica consistenza del materiale di base







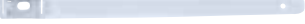

FISSAGGI IDRAULICI ED ELETTRICI CHIODI

	LINEA	APPLICAZIONI RACCOMANDATE	PAG
	CH	Chiodo in acciaio temperato con collarino.	115
	CHP	Punzone per installazione manuale chiodo in acciaio.	115
	BTS	Bandella per fissaggio con chiodi in acciaio temperato.	115
	BP	Bandella preforata.	115

FISSAGGI IDRAULICI ED ELETTRICI FASCETTE

	LINEA	APPLICAZIONI RACCOMANDATE	PAG
	FSC-B	Fascetta in nylon per cablaggi elettrici e per fissaggi di rete da ponteggio.	116
	FSC-V		116
	FSC-G		117
	FSC-R		117
	FSC-BL		117
	FSC-N		118
	VTN	Fascetta universale fissatubi	118



ACCESSORI PER FASCETTE TUBI

	LINEA	APPLICAZIONI RACCOMANDATE	PAG
	BSF	Basetta bidirezionale adesiva per fascette.	119
	TUBE-FIX	Sistema di fissaggio di tubi per installazione su muratura piena, forata e cartongesso tramite apposito adattatore.	119
	GRAP-FIX tassello singolo		119
	GRAP-FIX tassello doppio		120
	CLIP-FIX		120
	NFA fissatubo aperto		Fissatubi in poliammide.
	NCF fissatubo chiuso	121	
	FBP W1 - 9 MM FBP W1 - 12 MM FBP W2 - 9 MM FBP W2 - 12 MM FBP W4 - 9 MM FBP W4 - 12 MM	Fascette in acciaio stringitubo.	122 123 124
	FM MT W2 - 9 MM FM MT W4 - 9 MM	Rotolo fascetta metrica stringitubo.	125











= applicazione idonea

= previa verifica consistenza del materiale di base













ACCESSORI PER FASCETTE TUBI

	LINEA	APPLICAZIONI RACCOMANDATE	PAG
	FBP - MT	Carrello per fascetta metrica W2 e W4 stringitubo	125
	FBP-CF C7	Stringifascette manuale fem. 7.	125

ACCESSORI PER FISSAGGI E VITERIE

	LINEA	APPLICAZIONI RACCOMANDATE	PAG
	RPZ	Rondelle in acciaio	126
	 ROND-IX INOX	Rondelle in acciaio inox A2 IN 9021 UNI 6593 B	126
	 RQ-I	Rondella quadrata 70x70 per isolamento.	126
	B-FIL	Barre filettate in acciaio zincato bianco o inox a richiesta.	127
	BAR-F	Dado esagonale alto zincato bianco, per connessione barre filettate.	127
	DMZ	Dado esagonale.	128
	 DMX A2	Dado esagonale Inox.	128
	DA-Z	Dado autobloccante acciaio o Inox a richiesta.	128





ACCESSORI PER FISSAGGI E VITERIE

	LINEA	APPLICAZIONI RACCOMANDATE	PAG
	VITE TSP	Vite truciolare, zincata bianca impronta Pozi.	129
	TRF	Vite truciolare, zincata bianca testa esagono.	131
	W	Vite zincata gialla, autosvasante con impronta Torx per coperture di tetti in legno e strutture lignee.	132
	RW	Rondella tropicalizzata da abbinare a vite lunga W.	132
	AUT-LA	Vite zincata bianca, flangiata bombata testa esagono punta a chiodo per ancoraggi su legno, lastre truciolari, legno lamellare pannelli sandwich, lamiere ondulate e grecate.	133
	PERF-LA	Vite zincata bianca, flangiata bombata testa esagono punta a trapano per ancoraggi su legno, lastre truciolari, legno lamellare pannelli sandwich, lamiere ondulate e grecate.	133
	GUA-RC	Guarnizioni romboidali catramate.	134
	ROND-RM/PLA	Rondella romboidale in plastica.	134
	ROND-RM/LA	Rondella romboidale zincata.	134
	BR	Barretta zincata per coperture.	135
	VFX	Vite a doppio filetto (metrico + legno) per fissaggio di sistemi fotovoltaici, assemblata con guarnizione in EPDM e 3 dadi esagonali flangiati e rondella, in acciaio INOX A2-70 (AISI 304) certificata CE (EN 14592).	135
	BR-AP	Barra appendi pensili spessore 1,2 mm altezza 50 mm	135

= applicazione idonea





= previa verifica consistenza del materiale di base

ACCESSORI PER FISSAGGI E VITERIE



	LINEA	APPLICAZIONI RACCOMANDATE	PAG
	ROND-CA	Rondelle inox con cappellino a tenuta stagna.	136
	ROND-CB	Rondella inox verniciata con cappellino a tenuta stagna per viti	136
	ROND-CV	Rondelle acciaio zincato, coniche vulcanizzate per viti autoforanti da coperture.	136
	CPL	Cappellotti in acciaio con guarnizione a tenuta stagna	137
	ROND-PVC	Rondella in pvc trasparente per coperture in lamiera.	137
	ROND-LP	Rondella in policarbonato con tappo per il fissaggio di lastre in pvc.	137

FISSAGGI CHIMICI

MATERIALE DI SUPPORTO

LINEA	APPLICAZIONI RACCOMANDATE	CALCESTRUZZO	PIETRA NATURALE	MATTONI PIENI	MATTONI CLS PIENO	CLS CELLULARE	LEGNO	MATTONI FORATI	MATTONI CLS FORATO	CARTONGESSO	MATERIALI ISOLANTI	PAG
 NCE 300 400 ML	Ancorante chimico ad iniezione, a base vinilestere senza stirene, ad alto valore di aderenza ed elevate prestazioni. Per fissaggi pesanti, omologata ETA in opzione 1, su zone compresse per calcestruzzo non fessurato.											140
 NCE PLUS 300 420 ML	Ancorante chimico ad iniezione, a base uretan-metacrilato, ad elevate prestazioni. Per fissaggi pesanti, omologato sismico C1/C2 e opzione 1 per zone tese, fessurate e compresse.											140
 NCF 300 400 ML	Ancorante chimico ad iniezione, a base poliestere senza stirene, ad alto valore di aderenza ed elevate prestazioni. Per fissaggi pesanti, omologata per uso su muratura.											141
 NCS 300 410 ML	Ancorante chimico ad iniezione, a base poliestere, ad alto valore di aderenza. Per fissaggi medio-pesanti.											141

FISSAGGI CHIMICI
MATERIALE DI SUPPORTO

LINEA	APPLICAZIONI RACCOMANDATE	CALCESTRUZZO	PIETRA NATURALE	MATTONI PIENI	MATTONI CLS PIENO	CLS CELLULARE	LEGNO	MATTONI FORATI	MATTONI CLS FORATO	CARTONGESSO	MATERIALI ISOLANTI	PAG
 NCX	 Ancorante ad iniezione a base epossidica pura, senza stirene ad elevate prestazioni. Sismico C1 e C2 ETA opzione 1, con valutazione tecnica europea. Per uso su calcestruzzo fessurato, non fessurato e zona sismica.											142

ACCESSORI PER FISSAGGI CHIMICI

LINEA	APPLICAZIONI RACCOMANDATE	PAG
 PST-NCX	Pistola professionale per cartucce syde by syde da ml 384-400-585.	142
 MIXER E PROLUNGA PER NCX	Miscelatore con elicoidale interno per estrusione di resina chimica.	142
 PST-RB	Pistola Basic silicone.	143
 PST-RP	Pistola Professionale per cartuccia resina 300 ml.	143
 PST-BT	Pistola Professionale a batteria per cartucce da 380 ml a 420 ml.	143
 MIXER	Miscelatore con elicoidale interno per estrusione di resina chimica.	143
 AM	Pompa per rimozione di polvere residua dopo l'operazione di foratura.	144
 SCO	Scovolino in acciaio per rimozione di polvere residua e incremento di grip dopo l'operazione di foratura.	144
 ALB	Bussola in acciaio con filettatura interna, con superficie zigrinata per l'incremento del grip nel foro.	145

= applicazione idonea

= previa verifica consistenza del materiale di base





ACCESSORI PER FISSAGGI CHIMICI

	LINEA	APPLICAZIONI RACCOMANDATE	PAG
	GN - GDN	Gabbiette a rete in polipropilene singole, doppie e prolungate per fissaggi chimici, idonee per applicazioni su materiali compatti, semicompatti e forati.	145
	GM	Gabbietta in acciaio da 1mt per fissaggi chimici con profondità variabili.	145
	VCG	Viti di giunzione. Passo metrico e passo legno	146
	BR	Barretta filettata classe di resistenza 4.8.	146
	OC	Occhiolo stampato a freddo zincato bianco con filettatura metrica per fissaggi chimici.	147
	GA	Gancio stampato a freddo zincato bianco con filettatura metrica per fissaggi chimici.	147

SILICONI E SIGILLANTI

	LINEA	APPLICAZIONI RACCOMANDATE	PAG
	911 NS A SILICONE ACETICO	Sigillante silconico a polimerizzazione acetica, monocomponente, per sigillature generali col. trasparente, bianco, nero o avorio.	148
	993 NS N SILICONE NEUTRO	Sigillante silconico a polimerizzazione neutra alcolico, monocomponente a basso modulo, per sigillature generali col. trasparente, bianco, alluminio o testa di moro.	148
	912 NS AS SILICONE PER SANITARI	Sigillante silconico a polimerizzazione acetica, monocomponente per sigillature generali col. trasparente o bianco indicato per sanitari.	149
	934 NS L SILICONE LATTONERIA	Sigillante silconico a polimerizzazione neutra, monocomponente a basso modulo, indicato per applicazioni sigillanti all'esterno col. grigio o testa di moro.	149
	952 NS A-AT ALTE TEMPERATURE	Sigillante silconico a polimerizzazione acetica, monocomponente per alte temperature col. rosso.	150



SILICONI E SIGILLANTI

	LINEA	APPLICAZIONI RACCOMANDATE	PAG
	930 NSG AC SIGILLANTE ACRILICO	Colla di montaggio monocomponente a base acrilica, ideale per incollaggio di pannelli leggeri, piastrelle e interni col.bianco o grigio.	151
	931 NSG AC ACRILICO EFFETTO RUVIDO	Colla di montaggio monocomponente a base acrilica, ideale per incollaggio di pannelli leggeri, piastrelle e interni col.bianco effetto ruvido.	151
	981 MS-BT SIGILLANTE BITUMINOSO	Sigillante adesivo per giunzione e riparazione di guaine di copertura, sigillatura fissaggi, o attraversamenti su guaine impermeabilizzanti e staffaggi di pannelli solari.	152
	971 NS SIGILLANTE CRISTALLO	Sigillante adesivo base ibrida, ad alta viscosità, per incollaggi rapidi di materiali porosi e lisci, interni ed esterni inclusi plastica, vetro, legno muratura.	152

ACCESSORI SILICONI E SIGILLANTI

	LINEA	APPLICAZIONI RACCOMANDATE	PAG
	PST-SB	Pistola Basic per silicone.	153
	PST-SP	Pistola Professionale per silicone.	153
	BS	Beccuccio di ricambio per cartucce silicone.	153



SCHIUME POLIURETANICHE

	LINEA	APPLICAZIONI RACCOMANDATE	PAG
	NSP MANUALE	Schiuma poliuretana monocomponente ideale per sigillatura serramenti, crepe, buchi e interstizi attorno a tubi, versione manuale.	154
	NSP PER PISTOLA	Colla di montaggio monocomponente a base acrilica, ideale per incollaggio di pannelli leggeri, piastrelle e interni, col.bianco effetto ruvido.	154



= applicazione idonea

= previa verifica consistenza del materiale di base









SCHIUME POLIURETANICHE

	LINEA	APPLICAZIONI RACCOMANDATE	PAG
	NSP-TT SCHIUMA MANUALE PER TETTI	Schiuma poliuretana monocomponente ideale per sigillatura serramenti, crepe, buchi e interstizi attorno a tubi, versione per pistola.	154
	NSP-TT SCHIUMA PER PISTOLA PER TETTI	Schiuma poliuretana monocomponente ideale per sigillatura e giunzione su tetti muri e soffitti, versione a pistola.	154
	NSP-C PER PISTOLA	Schiuma poliuretana monocomponente ideale per applicazione di pannelli per cappotto, versione a pistola.	155
	NSP-SP SOLVENTE PULITORE	Solvente per resina poliuretana per pistola.	155

ACCESSORI PER SCHIUME

	LINEA	APPLICAZIONI RACCOMANDATE	PAG
	PPS	Pistola professionale per applicazione schiuma poliuretana.	156
	PPS-T	Pistola professionale per applicazione schiuma poliuretana con valvola teflonata.	156
	CR	Cannuccia di ricambio per schiuma poliuretana manuale.	156

SPRAY TECNICI

	LINEA	APPLICAZIONI RACCOMANDATE	PAG
	NST	LO SBLOCCANTE LUBRIFICANTE NST 50 e quello con alte performance per le incrostazioni più ostinate NST 90 SS proteggono dall'ossidazione grazie al potere anticorrosivo, penetrano in profondità sbloccando le parti grippate, lubrificano i componenti dei meccanismi, ricoprono le parti con cui viene a contatto creando una barriera protettiva contro ruggine e umidità.	158
	NST90SS		158
	NST98	IL SILICONE SPRAY NTS 98 ha funzione lubrificante e scivolante su cavi, guaine, metallo, plastica, gomma, ecc... isola, lucida e ha funzione idrorepellente; impermeabilizza creando un film oleoso di protezione ostacolando anche l'ossidazione nei metalli.	158
	NST 125	IL GRASSO MULTIUSO CON PTFE NST 125 ad elevato potere lubrificante per le parti meccaniche additivato con PTFE permette una lubrificazione in profondità, offre una protezione alla corrosione e riduce l'attrito tra le parti meccaniche favorendone l'avvio.	159
	NST 100	L'OLIO DI VASELINA NST 100 viene utilizzato per lubrificare macchinari e strumenti di precisione, cerniere e serrature. È incolore e inodore e non lascia macchie.	159
	NST 80	L'OLIO DA TAGLIO NST 80, viene utilizzato per prevenire l'usura e facilitare le operazioni di taglio e perforazione con utensili manuali ed elettro utensili, quali seghe, frese, dischi, punte, macchinari per taglio piastrelle, ecc... aumentandone la durata, facilitandone l'utilizzo, riducendone l'attrito e l'aumento di calore dovuto all'utilizzo intensivo e continuato.	159
	NST 150 CHIARO 99%	GLI ZINCANTI NST 150 proteggono tutte le superfici zincate o materiali ferrosi, quali ringhiere, inferriate, tubazioni idrauliche, tubazioni per ponteggi, giunti, opere di carpenteria, saldature dalla corrosione creando un film protettivo ad alto contenuto di zinco sovraverniciabile. Nelle sue tre versioni, permette nella versione chiara e brillante di ritoccare manufatti nuovi, e nelle versioni scure manufatti esposti alla luce solare o invecchiati o esposti alle intemperie.	160
	NST 150 S BRILLANTE 99% CHIARO		160
	NST 150 GT ZINCANTE 400°C		160

= applicazione idonea

= previa verifica consistenza del materiale di base

SPRAY TECNICI













	LINEA	APPLICAZIONI RACCOMANDATE	PAG
	NST 180	IL PULITORE PER CONTATTI NST 180 aderisce al metallo rimuovendone sporco ed umidità, eliminando e prevenendo cortocircuiti e dispersioni di corrente elettrica. Viene utilizzato su interruttori, motori elettrici, circuiti, pannelli elettrici, generatori di corrente, candele.	161
	NST 250	IL RIMUOVI SILICONE NST 250 è un solvente che viene utilizzato per rimuovere residui di silicone da superfici, fughe, infissi, ecc... I campi di applicazioni sono molteplici e vanno dalla meccanica, al settore automobilistico, dalla ferramenta, alla nautica, dall'edilizia civile a quella industriale.	161
	NST 200	L'ARIA COMPRESSA NST 200 elimina facilmente polvere, sporcizia, residui di grasso, unto. È indicata nel settore elettrico (interruttori), nel settore informatico (circuiti stampati, stampanti, fotocopiatrici, ecc...) e per strumenti ad alta precisione.	161
	883 TRACCIANTE GIALLO FLUORESCENTI	Tracciante giallo spray.	162
	883 TRACCIANTE ROSSO FLUORESCENTI	Tracciante rosso spray.	162

FISSAGGI PER PONTEGGI, FUNI E CAVI

MATERIALE DI SUPPORTO

LINEA	APPLICAZIONI RACCOMANDATE	CALCESTRUZZO	PIETRA NATURALE	MATTONI PIENI	MATTONE CLS PIENO	CLS CELLULARE	LEGNO	MATTONI FORATI	MATTONE CLS FORATO	CARTONGESSO	MATERIALI ISOLANTI	PAG
 <p>PTA T1 PTA T2</p> <p> Rapporto di prova</p>	Golfare in acciaio forgiato per ponteggi e strutture provvisorie, ad espansione per installazioni distanziate. Idoneo per applicazioni su materiali compatti per carichi di elevata portata.											166
 <p>PTA T3 PTA T4</p>	Golfare in acciaio a corpo unico forgiato per ponteggi e strutture provvisorie, ad espansione per installazioni distanziate. Idoneo per applicazioni su materiali compatti per carichi di elevata portata.											167









FISSAGGI PER PONTEGGI, FUNI E CAVI
MATERIALE DI SUPPORTO

LINEA	APPLICAZIONI RACCOMANDATE	CALCESTRUZZO	PIETRA NATURALE	MATTONI PIENI	MATTONE CLS PIENO	CLS CELLULARE	LEGNO	MATTONI FORATI	MATTONE CLS FORATO	CARTONGESSO	MATERIALI ISOLANTI	PAG
 PTA-K  	Golfare in acciaio forgiato per ponteggi e strutture provvisorie, ad espansione, per installazioni distanziate. Idoneo per applicazioni su materiali compatti in presenza di sistemi a cappotto per carichi di elevata portata.											168
 OC-G 	Occhio in acciaio filo 12, mordente legno Ø 51.											168
 PTRO-G	Golfare Ø 51 per ponteggi e strutture provvisorie, composto da occhio mordente legno filo 12 e tassello ad espansione in nylon, per installazioni distanziate. Idoneo per applicazioni su materiali compatti per carichi di elevata portata.											169
 ABP	Tassello in nylon ad espansione controllata, idoneo per fissaggi medio pesanti e golfari da ponteggio.											169
 OC-24 	Occhio in acciaio filo 12 mordente legno Ø 24.											170
 PTRO Ø 24 	Golfare Ø 24 per ponteggi e strutture provvisorie, composto da occhio mordente legno filo 12 e tassello ad espansione in nylon, per installazioni distanziate. Idoneo per applicazioni su materiali compatti per carichi di elevata portata.											170
 NX-OCS Ø 23 	Ancoraggio in acciaio non passante ad espansione. Idoneo per applicazioni su materiali compatti per carichi di forte portata. Corpo prolungato occhio da Ø 23 mm.											171













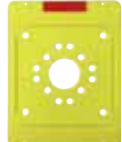

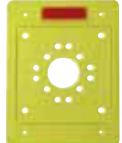









= applicazione idonea

= previa verifica consistenza del materiale di base

ACCESSORI PER SCHIUME

	LINEA	APPLICAZIONI RACCOMANDATE	PAG
	KIT TESTER	Tester portatile per prove di ancoraggio e tenuta, su golfari da ponteggio.	171
	TA-U	Tappo copriforo per ponteggi, multi-diametro.	171
	PPPG Ø 48 L 300	Elemento di collegamento utilizzato per l'ancoraggio del ponteggio metallico fisso a parete o struttura preesistente. Viene collegato al ponteggio attraverso un morsetto ortogonale, mentre il perno o gancio viene inserito in un occhiolo metallico fissato alla parete di supporto tramite tassello in materiale plastico Ø 48.	172
	PPPG Ø 48 L 480		172
	PPPG Ø 48 L 1000		172
	PPPG Ø 18 L 300	Elemento di collegamento utilizzato per l'ancoraggio del ponteggio metallico fisso, a parete o struttura preesistente. Viene collegato al ponteggio attraverso un morsetto ortogonale, mentre il perno o gancio viene inserito in un occhiolo metallico fissato alla parete di supporto tramite tassello in PPPG Ø 18 materiale plastico. Ø 18.	173
	PPPG Ø 18 L 500		173
	T	Il Gancio a T viene utilizzato come elemento intermedio di collegamento e ancoraggio tra il ponteggio e il tassello con occhiolo alla struttura del fabbricato, oggetto di opere di manutenzione ordinaria e/o straordinaria.	173





ACCESSORI PER PONTEGGI IN POLIPROPILENE

	LINEA	APPLICAZIONI RACCOMANDATE	PAG
	 NSB 	Sottobasetta per basi da ponteggio universale, impilabile, ad alta capacità di carico 215x185 mm.	174
	 SQ-T 	Sottobasetta per basi da ponteggio rettangolare, impilabile, ad alta capacità di carico 245x185.	174
	 SQ-I 	Sottobasetta per basi da ponteggio rettangolare, impilabile, ad alta capacità di carico 245x185. Inclinata a 5° impilabile per aumentare il grado di inclinazione.	174
	 ST 	Sottobasetta per basi ponteggio universale, impilabile a base tonda.	175
	 STR 5 	Sottobasetta rinforzata, a ripartizione di carico, altezza 5 cm.	175
	 CB 	Coprigiunto basic	175
	 CDM	Coprigiunto doppio per giunto multidirezionale.	176
	 SCM	Coprirosetta per giunto multidirezionale.	176
	 NGC 50	Copritubo ad innesto con catarifrangente cm 50 Ø 48.	176
	 NCT	Copritubo ad innesto con catarifrangente Ø 48.	177

= applicazione idonea









= previa verifica consistenza del materiale di base

ACCESSORI PER PONTEGGI IN POLIPROPILENE

	LINEA	APPLICAZIONI RACCOMANDATE	PAG
	 TPE 48	Tappo segnalatore morbido giallo, per tubo Ø 48.	177
	 FPR	Fungo segnalatore rigido rosso, Ø 6 -22 / Ø 22-35.	177

ACCESSORI PER PONTEGGI, FUNI E CAVI

MATERIALE DI SUPPORTO

LINEA	APPLICAZIONI RACCOMANDATE	CALCESTRUZZO	PIETRA NATURALE	MATTONI PIENI	MATTONE CLS PIENO	CLS CELLULARE	LEGNO	MATTONI FORATI	MATTONE CLS FORATO	CARTONGESSO	MATERIALI ISOLANTI	PAG
 CA-R	Copritubo in PE estruso, antiurto.											178
 NS 200 m	Nastro segnalatore bianco/rosso, altezza 7cm.											178
 NS-LV H10-200 m	Nastro segnalatore "lavori in corso" bianco/rosso altezza 10 cm.											178
 SPINA VERMALE	Gancio di sicurezza per ponteggi zincato, Ø6 / Ø8 / Ø10 per tubo Ø 48.											178
 BULLONE RICAMBIO	Bulloni di ricambio 1/2", per giunti da ponteggio.											179
  SXP-ORD	Ancorante di tipo passante per reti anticaduta, per installazione distanziata della rete. Con gancio a doppio ricciolo e dal tassello SXP omologato ETA in opzione 7 per zone compresse.											179
  OR-L	Gancio a ricciolo per fissaggio di fune Ø 13, da abbinare a tassello ABP14x100.											179

ACCESSORI PER PONTEGGI, FUNI E CAVI

	LINEA	APPLICAZIONI RACCOMANDATE	PAG
	CHP 21-22	Chiave poligonale nuda 21/22.	180
	CHP-R 21-22	Chiave poligonale manico plastica 21/22.	180
	CCHC-C CHC-NN	Chiave a cricchetto nuda 21/22.	180
	CHC-CR	Chiave nera a cricchetto rivestita 21/22.	180
	CHC-CN	Chiave a cricchetto 21/22 plastificata.	181

PUNTE DA TRAPANO

	LINEA	APPLICAZIONI RACCOMANDATE	PAG
	HSS	Punta elicoidale cilindrica, rullata, per forare tutti i tipi di metallo.	204
	HSS FRESATA	Punta elicoidale cilindrica, fresata, interamente rettificata. Per foratura di metalli ad alte prestazione e precisione Din 338, finitura lucida.	205
	HSS COBALTO 5%	Punta elicoidale cilindrica cobalto 5%. Per foratura di metalli ad alte prestazione e precisione Din 338.	206
	HSS COBALTO 8%	Punta elicoidale cilindrica cobalto 8%. Per foratura di metalli ad alte prestazione e precisione Din 338.	207
	HM SU	Punta con placchette di alta qualità, per perforare a forte percussione pareti murarie, calcestruzzo, marmo e pietra naturale.	208
	SDS-PLUS 4	Punta per trapani a martello con attacco SDS PLUS, taglio a roto-percussione 4 taglienti. Per pareti murarie, calcestruzzo, pietre naturali.	209
	SDS-MAX 3	Punta per trapani a martello con attacco SDS MAX, taglio a roto-percussione 3 taglienti. Per pareti murarie, calcestruzzo, pietre naturali.	210
	SDS PLUS	Adattatore attacco esagonale M16.	211

= applicazione idonea

= previa verifica consistenza del materiale di base

PUNTE DA TRAPANO

	LINEA	APPLICAZIONI RACCOMANDATE	PAG
	ACCESSORI E SCALPELLI	Scalpelli per trapano a martello con innesto sds-plus e sds-max.	211
	FRESA A CORONA	Fresa a corona 50 mm con attacco M16.	212
	PROLUNGA ESAGONALE	Prolunga attacco esagonale M16.	212
	PROLUNGA SDS PLUS	Prolunga attacco SDS PLUS M16.	212
	FRESA A CORONA	Fresa a corona 50 mm con attacco M22.	213
	PROLUNGA SDS PLUS	Prolunga attacco SDS PLUS M22.	213
	PUNTA CENTRATORE	Punta centratore per prolunga.	213
	FRESA A CORONA SDS MAX	Fresa a corona per applicazioni a roto-percussore.	214
	PROLUNGA SDS MAX	Prolunga attacco SDS MAX.	214
	PUNTA CENTRATORE	Punta centratore per prolunga, SDS MAX.	214
	PEL	Punta elicoidale cilindrica deoppia elica per legno.	215
	BIT	Punta elicoidale cilindrica doppia elica per legno.	215
	PORTAINSERTI MAGNETICO	Portainseriti magnetico con attacco esagonale 1/4".	217
	PORTAINSERTI QUICK	Portainseriti quick con attacco esagonale 1/4".	217

**FISSAGGI
METALLICI**

FISSAGGI METALLICI

TM-C7	2
TM-C7 INOX	3
TM-FL	4
TMX	5
TM-CS	6
NX	8-11
HSP	12-13
HPM	14-15
SXP	16-20
SXC/SKB/SXB	22-25
DROP/PUNZONE	26-27
NTO	27
SXL	28-29
DIBOLT	30-31
SCB	32-33
AUT-C	34

Tasselli in acciaio passanti

Tassello in acciaio passante ad espansione, per calcestruzzo fessurato e non fessurato, idoneo per applicazioni su materiali compatti per carichi di elevata portata. Disponibili in opzione 7, C1-C2, INOX A2 e A4. Indicato per Carpenteria pesante, strutture provvisoriale, scaffalature industriali, tende da sole, ancoraggi di impianti di condizionamento ed elettrici, mensole, scale, binari per ascensori, strutture porta cavi, cancelli e inferriate, segnaletica stradale, arredo urbano, ecc

MATERIALI DI SUPPORTO CALCESTRUZZO, PIETRA NATURALE, MATTONI PIENI, MATTONE CLS PIENO

TM C7 - Tasselli passanti in acciaio

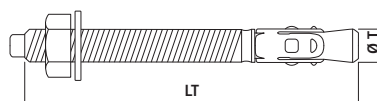

opzione 7



Codice	Descrizione	Ø T mm	LT mm	T/FIX mm	Scatola singola	Imballo complessivo
NB56185*	Tasselli passanti in acciaio TM C 7 6x60	6	60	2	200 pz	5 Scatole
NB56190*	Tasselli passanti in acciaio TM C 7 6x80	6	80	22	200 pz	5 Scatole
NB56200	Tasselli passanti in acciaio TM C 7 8x60	8	60	3	100 pz	5 Scatole
NB56205	Tasselli passanti in acciaio TM C 7 8x75	8	75	5	100 pz	5 Scatole
NB56210	Tasselli passanti in acciaio TM C 7 8x90	8	90	30	100 pz	5 Scatole
NB56215	Tasselli passanti in acciaio TM C 7 8x120	8	120	45	50 pz	5 Scatole
NB56300	Tasselli passanti in acciaio TM C 7 10x80	10	80	13	50 pz	5 Scatole
NB56305	Tasselli passanti in acciaio TM C 7 10x90	10	90	15	50 pz	5 Scatole
NB56307	Tasselli passanti in acciaio TM C 7 10x100	10	100	25	50 pz	5 Scatole
NB56310	Tasselli passanti in acciaio TM C 7 10x120	10	120	40	50 pz	5 Scatole
NB56315	Tasselli passanti in acciaio TM C 7 10x140	10	140	60	25 pz	5 Scatole
NB56320	Tasselli passanti in acciaio TM C 7 10x160	10	160	80	25 pz	5 Scatole
NB56390	Tasselli passanti in acciaio TM C 7 12x90	12	90	13	25 pz	5 Scatole
NB56400	Tasselli passanti in acciaio TM C 7 12x100	12	100	20	25 pz	5 Scatole
NB56405	Tasselli passanti in acciaio TM C 7 12x110	12	110	23	25 pz	5 Scatole
NB56407	Tasselli passanti in acciaio TM C 7 12x120	12	120	28	25 pz	5 Scatole
NB56410	Tasselli passanti in acciaio TM C 7 12x140	12	140	48	25 pz	5 Scatole
NB56415	Tasselli passanti in acciaio TM C 7 12x160	12	160	68	25 pz	5 Scatole
NB56420	Tasselli passanti in acciaio TM C 7 12x180	12	180	88	10 pz	5 Scatole
NB56520*	Tasselli passanti in acciaio TM C 7 14x120	14	120	22	25 pz	5 Scatole
NB56545*	Tasselli passanti in acciaio TM C 7 14x145	14	145	37	25 pz	5 Scatole
NB56600	Tasselli passanti in acciaio TM C 7 16x125	16	125	10	10 pz	5 Scatole
NB56605	Tasselli passanti in acciaio TM C 7 16x145	16	145	23	10 pz	5 Scatole
NB56610	Tasselli passanti in acciaio TM C 7 16x175	16	175	48	10 pz	5 Scatole
NB56670*	Tasselli passanti in acciaio TM C 7 20x170	20	170	23	5 pz	5 Scatole
NB56770*	Tasselli passanti in acciaio TM C 7 20x220	20	220	73	5 pz	5 Scatole

*Tasselli privi di ETA

TM C 7 - Tasselli passanti in acciaio inox A4

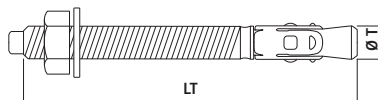

Inox A4

Codice	Descrizione	Ø T mm	LT mm	T/FIX mm	Scatola singola	Imballo complessivo
NB57113	Tasselli passanti in acciaio inox A4 TM C 7 8x75	8	75	5	100 pz	5 Scatole
NB57116	Tasselli passanti in acciaio inox A4 TM C 7 8x90	8	90	20	100 pz	5 Scatole
NB57119	Tasselli passanti in acciaio inox A4 TM C 7 8x115	8	115	45	50 pz	5 Scatole
NB57130	Tasselli passanti in acciaio inox A4 TM C 7 10x70	10	70	3	100 pz	5 Scatole
NB57133	Tasselli passanti in acciaio inox A4 TM C 7 10x90	10	90	10	50 pz	5 Scatole
NB57136	Tasselli passanti in acciaio inox A4 TM C 7 10x120	10	120	40	50 pz	5 Scatole
NB57139	Tasselli passanti in acciaio inox A4 TM C 7 10x150	10	150	70	10 pz	5 Scatole
NB57150	Tasselli passanti in acciaio inox A4 TM C 7 12x75	12	75	5	25 pz	5 Scatole
NB57153	Tasselli passanti in acciaio inox A4 TM C 7 12x90	12	90	13	25 pz	5 Scatole
NB57156	Tasselli passanti in acciaio inox A4 TM C 7 12x110	12	110	18	25 pz	5 Scatole
NB57159	Tasselli passanti in acciaio inox A4 TM C 7 12x140	12	140	48	25 pz	5 Scatole
NB57170	Tasselli passanti in acciaio inox A4 TM C 7 16x90	16	90	5	20 pz	5 Scatole
NB57173	Tasselli passanti in acciaio inox A4 TM C 7 16x145	16	145	25	10 pz	5 Scatole
NB57176	Tasselli passanti in acciaio inox A4 TM C 7 16x170	16	170	48	10 pz	5 Scatole
NB57190	Tasselli passanti in acciaio inox A4 TM C 7 20x120	20	120	5	5 pz	5 Scatole
NB57193	Tasselli passanti in acciaio inox A4 TM C 7 20x170	20	170	25	5 pz	5 Scatole
NB57196	Tasselli passanti in acciaio inox A4 TM C 7 20x220	20	220	73	5 pz	5 Scatole

Installazione di strutture porta cavi e carpenteria pesante



Tasselli in acciaio passanti

MATERIALI DI SUPPORTO CALCESTRUZZO, PIETRA NATURALE, MATTONI PIENI, MATTONE CLS PIENO

TM-FL - Tasselli in acciaio passante

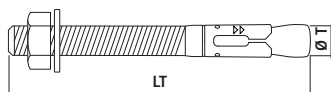

Codice	Descrizione	Ø T mm	LT mm	T/FIX mm	Scatola singola	Imballo complessivo
NB52979	Tassello in acciaio passante TM-FL 6x45	6	45	1	200 pz	5 Scatole
NB54300	Tassello in acciaio passante TM-FL 6x60	6	60	2	200 pz	5 Scatole
NB52986	Tassello in acciaio passante TM-FL 6x80	6	80	22	200 pz	5 Scatole
NB52988	Tassello in acciaio passante TM-FL 6x100	6	100	42	100 pz	5 Scatole
NB59633	Tassello in acciaio passante TM-FL 8x50	8	50	4	100 pz	5 Scatole
NB59635	Tassello in acciaio passante TM-FL 8x65	8	65	8	100 pz	5 Scatole
NB52993	Tassello in acciaio passante TM-FL 8x75	8	75	5	100 pz	5 Scatole
NB53006	Tassello in acciaio passante TM-FL 8x90	8	90	20	100 pz	5 Scatole
NB59640	Tassello in acciaio passante TM-FL 8x115	8	115	45	50 pz	5 Scatole
NB61520	Tassello in acciaio passante TM-FL 8x130	8	130	60	50 pz	5 Scatole
NB61522	Tassello in acciaio passante TM-FL 8x160	8	160	85	25 pz	5 Scatole
NB61524	Tassello in acciaio passante TM-FL 8x180	8	180	90	20 pz	5 Scatole
NB61526	Tassello in acciaio passante TM-FL 8x200	8	200	130	20 pz	5 Scatole
NB53013	Tassello in acciaio passante TM-FL 10x70	10	70	3	50 pz	5 Scatole
NB53014	Tassello in acciaio passante TM-FL 10x80	10	80	13	50 pz	5 Scatole
NB53020	Tassello in acciaio passante TM-FL 10x90	10	90	10	50 pz	5 Scatole
NB53025	Tassello in acciaio passante TM-FL 10x100	10	100	20	50 pz	5 Scatole
NB53037	Tassello in acciaio passante TM-FL 10x120	10	120	40	50 pz	5 Scatole
NB53039	Tassello in acciaio passante TM-FL 10x140	10	140	60	50 pz	5 Scatole
NB53043	Tassello in acciaio passante TM-FL 10x150	10	150	70	50 pz	5 Scatole
NB53041	Tassello in acciaio passante TM-FL 10x170	10	170	90	25 pz	5 Scatole
NB53047	Tassello in acciaio passante TM-FL 10x210	10	210	130	20 pz	5 Scatole
NB53049	Tassello in acciaio passante TM-FL 12x75	12	75	5	50 pz	5 Scatole
NB53044	Tassello in acciaio passante TM-FL 12x90	12	90	13	25 pz	5 Scatole
NB74988	Tassello in acciaio passante TM-FL 12x110	12	110	18	25 pz	5 Scatole
NB59664	Tassello in acciaio passante TM-FL 12x140	12	140	48	25 pz	5 Scatole
NB61537	Tassello in acciaio passante TM-FL 12x160	12	160	68	25 pz	5 Scatole
NB61540	Tassello in acciaio passante TM-FL 12x180	12	180	88	25 pz	5 Scatole
NB61543	Tassello in acciaio passante TM-FL 12x200	12	200	120	20 pz	5 Scatole
NB61545	Tassello in acciaio passante TM-FL 12x240	12	240	150	10 pz	5 Scatole
NB54105	Tassello in acciaio passante TM-FL 14x95	14	95	5	25 pz	5 Scatole
NB54110	Tassello in acciaio passante TM-FL 14x110	14	110	7	25 pz	5 Scatole
NB54115	Tassello in acciaio passante TM-FL 14x130	14	130	15	25 pz	5 Scatole
NB54120	Tassello in acciaio passante TM-FL 14x145	14	145	35	25 pz	5 Scatole
NB54125	Tassello in acciaio passante TM-FL 14x160	14	160	55	25 pz	5 Scatole
NB54130	Tassello in acciaio passante TM-FL 14x180	14	180	68	25 pz	5 Scatole
NB59671	Tassello in acciaio passante TM-FL 16x90	16	90	4	20 pz	5 Scatole
NB59673	Tassello in acciaio passante TM-FL 16x110	16	110	24	10 pz	5 Scatole
NB53075	Tassello in acciaio passante TM-FL 16x125	16	125	3	10 pz	5 Scatole
NB53082	Tassello in acciaio passante TM-FL 16x145	16	145	23	10 pz	5 Scatole
NB54287	Tassello in acciaio passante TM-FL 16x170	16	170	48	10 pz	5 Scatole
NB54292	Tassello in acciaio passante TM-FL 16x220	16	220	98	20 pz	3 Scatole
NB54294	Tassello in acciaio passante TM-FL 20x145	20	145	8	5 pz	5 Scatole
NB53341	Tassello in acciaio passante TM-FL 20x170	20	170	23	5 pz	5 Scatole
NB53358	Tassello in acciaio passante TM-FL 20x220	20	220	73	5 pz	5 Scatole
NB53360	Tassello in acciaio passante TM-FL 20x270	20	270	123	5 pz	5 Scatole
NB53362	Tassello in acciaio passante TM-FL 24x180	24	180	-	5 pz	2 Scatole
NB53364	Tassello in acciaio passante TM-FL 24x260	24	260	-	5 pz	2 Scatole



Tasselli in acciaio passanti

TMX - Tasselli passanti in acciaio inox A2 - A4

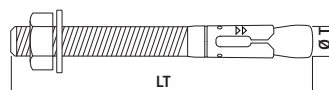

Inox A2

Codice	Descrizione	Ø T mm	LT mm	T/FIX mm	Scatola singola	Imballo complessivo
NB2240	Tassello passante in acciaio inox A2 TMX 8x50	8	50	4	100 pz	5 Scatole
NB2264	Tassello passante in acciaio inox A2 TMX M 8x75	8	75	5	100 pz	5 Scatole
NB2270	Tassello passante in acciaio inox A2 TMX M 8x115	8	115	45	50 pz	5 Scatole
NB2325	Tassello passante in acciaio inox A2 TMX M 10x90	10	90	10	50 pz	5 Scatole
NB2349	Tassello passante in acciaio inox A2 TMX M 10x120	10	120	40	50 pz	5 Scatole
NB2391	Tassello passante in acciaio inox A2 TMX M 12x90	12	90	13	25 pz	6 Scatole
NB2392	Tassello passante in acciaio inox A2 TMX M 12x100	12	100	-	25 pz	5 Scatole
NB2394	Tassello passante in acciaio inox A2 TMX M 12x110	12	110	18	25 pz	5 Scatole
NB2395	Tassello passante in acciaio inox A2 TMX M 12x120	12	120	-	25 pz	5 Scatole
NB2462	Tassello passante in acciaio inox A2 TMX M 16x125	16	125	3	10 pz	5 Scatole
NB2480	Tassello passante in acciaio inox A2 TMX M 16x150	16	150	-	10 pz	5 Scatole
NB2496	Tassello passante in acciaio inox A2 TMX M 20x160	20	160	-	5 pz	5 Scatole

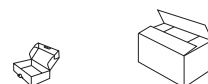

Inox A4

Codice	Descrizione	Ø T mm	LT mm	T/FIX mm	Scatola singola	Imballo complessivo
NB2400	Tassello passante in acciaio inox A4 TMX 8x50	8	50	4	100 pz	5 Scatole
NB2402	Tassello passante in acciaio inox A4 TMX 8x75	8	75	5	100 pz	5 Scatole
NB2404	Tassello passante in acciaio inox A4 TMX 8x115	8	115	45	50 pz	5 Scatole
NB2406	Tassello passante in acciaio inox A4 TMX 10x90	10	90	10	50 pz	5 Scatole
NB2408	Tassello passante in acciaio inox A4 TMX 10x120	10	120	40	50 pz	5 Scatole
NB2410	Tassello passante in acciaio inox A4 TMX 12x100	12	100	-	25 pz	5 Scatole
NB2412	Tassello passante in acciaio inox A4 TMX 12x120	12	120	-	25 pz	5 Scatole
NB2414	Tassello passante in acciaio inox A4 TMX 16x125	16	125	3	10 pz	5 Scatole
NB2416	Tassello passante in acciaio inox A4 TMX 16x150	16	150	-	10 pz	5 Scatole
NB2418	Tassello passante in acciaio inox A4 TMX 20x160	20	160	-	5 pz	5 Scatole

Tasselli in acciaio passanti
MATERIALI DI SUPPORTO CALCESTRUZZO, PIETRA NATURALE, MATTONI PIENI, MATTONE CLS PIENO

TM CS - Tasselli in acciaio passanti

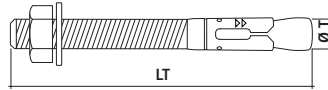
 Sismica
Cat. C1-C2

C1-C2

Codice	Descrizione	Ø T mm	LT mm	T/FIX mm	Scatola singola	Imballo complessivo
NB58000	Tassello in acciaio passante TM CS 8x80	8	80	10	50 pz	5 Scatole
NB58005	Tassello in acciaio passante TM CS 8x90	8	90	20	50 pz	5 Scatole
NB58010	Tassello in acciaio passante TM CS 8x110	8	110	40	50 pz	5 Scatole
NB58015	Tassello in acciaio passante TM CS 8x130	8	130	60	50 pz	5 Scatole
NB58020	Tassello in acciaio passante TM CS 8x170	8	170	100	25 pz	5 Scatole
NB58025	Tassello in acciaio passante TM CS 10x95	10	95	10	25 pz	5 Scatole
NB58030	Tassello in acciaio passante TM CS 10x105	10	105	20	25 pz	5 Scatole
NB58035	Tassello in acciaio passante TM CS 10x125	10	125	40	25 pz	5 Scatole
NB58040	Tassello in acciaio passante TM CS 10x145	10	145	60	25 pz	5 Scatole
NB58045	Tassello in acciaio passante TM CS 10x185	10	185	100	25 pz	5 Scatole
NB58050	Tassello in acciaio passante TM CS 10x245	10	245	160	15 pz	5 Scatole
NB58055	Tassello in acciaio passante TM CS 12x115	12	115	10	25 pz	5 Scatole
NB58060	Tassello in acciaio passante TM CS 12x125	12	125	20	25 pz	5 Scatole
NB58065	Tassello in acciaio passante TM CS 12x145	12	145	40	15 pz	5 Scatole
NB58070	Tassello in acciaio passante TM CS 12x165	12	165	60	15 pz	5 Scatole
NB58075	Tassello in acciaio passante TM CS 12x205	12	205	100	10 pz	5 Scatole
NB58080	Tassello in acciaio passante TM CS 12x225	12	225	120	10 pz	5 Scatole
NB58085	Tassello in acciaio passante TM CS 12x245	12	245	140	10 pz	5 Scatole
NB58090	Tassello in acciaio passante TM CS 12x265	12	265	160	10 pz	5 Scatole
NB58095	Tassello in acciaio passante TM CS 12x305	12	305	200	15 pz	3 Scatole
NB58100	Tassello in acciaio passante TM CS 12x350	12	350	245	15 pz	3 Scatole
NB58105	Tassello in acciaio passante TM CS 16x130	16	130	5	10 pz	5 Scatole
NB58110	Tassello in acciaio passante TM CS 16x145	16	145	20	10 pz	5 Scatole
NB58115	Tassello in acciaio passante TM CS 16x165	16	165	40	5 pz	5 Scatole
NB58120	Tassello in acciaio passante TM CS 16x225	16	225	100	5 pz	5 Scatole
NB58125	Tassello in acciaio passante TM CS 20x170	20	170	30	5 pz	5 Scatole
NB58130	Tassello in acciaio passante TM CS 20x200	20	200	60	5 pz	5 Scatole



▲ Installazione di linee di montaggio e attrezzature robotizzate

▼ Installazione di scale e parapetti



Tasselli in acciaio non passanti

Ancoraggio in acciaio non passante, ad espansione, idoneo per applicazioni su materiali compatti per carichi di elevata portata. Indicato per carpenteria pesante, strutture provvisorie, scaffalature metalliche, tende da sole, ancoraggi di impianti di condizionamento, idraulici ed elettrici, mensole, strutture porta-cavi, scale antincendio e di sicurezza macchinari, strutture per facciate ventilate, segnaletica stradale, profili, ecc...

MATERIALI DI SUPPORTO CALCESTRUZZO, PIETRA NATURALE, MATTONI PIENI, MATTONE CLS PIENO

NX - Tasselli in acciaio non passante

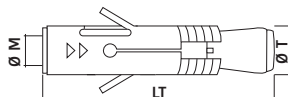

Codice	Descrizione	Ø M	LT mm	Ø T mm	Scatola singola	Imballo complessivo
NB17	Tassello in acciaio non passante NX M6x45	6	45	12	100 pz	5 Scatole
NB24	Tassello in acciaio non passante NX M8x55	8	55	14	50 pz	5 Scatole
NB31	Tassello in acciaio non passante NX M10x65	6	65	16	50 pz	5 Scatole
NB48	Tassello in acciaio non passante NX M12x75	12	75	20	25 pz	5 Scatole
NB55	Tassello in acciaio non passante NX M16x90	16	90	24	25 pz	5 Scatole



Confezioni industriali

Codice	Descrizione	Ø M mm	LT mm	Ø T mm	Scatola singola
NB88435	Bulk tassello in acciaio non passante NX M6x45	6	45	12	1.000 pz
NB88442	Bulk tassello in acciaio non passante NX M8x55	8	55	14	700 pz
NB88459	Bulk tassello in acciaio non passante NX M10x65	6	65	16	500 pz
NB88466	Bulk tassello in acciaio non passante NX M12x75	12	75	20	250 pz
NB88473	Bulk tassello in acciaio non passante NX M16x90	16	90	24	150 pz

NX-B - Tasselli in acciaio non passante con vite TE 8.8 e rondella

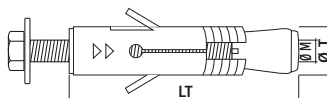

Codice	Descrizione	Ø M	LT mm	Ø T mm	Scatola singola	Imballo complessivo
NB79	Tassello in acciaio non passante NX-B M6x60 con vite TE 8.8 e rondella	6	45	12	50 pz	5 Scatole
NB86	Tassello in acciaio non passante NX-B M8x70 con vite TE 8.8 e rondella	8	55	14	50 pz	5 Scatole
NB93	Tassello in acciaio non passante NX-B M10x80 con vite TE 8.8 e rondella	10	65	16	40 pz	5 Scatole
NB109	Tassello in acciaio non passante NX-B M12x100 con vite TE 8.8 e rondella	12	75	20	20 pz	5 Scatole
NB277	Tassello in acciaio non passante NX-B M16x100 con vite TE 8.8 e	16	90	24	10 pz	5 Scatole



Disponibile in blister

Tasselli in acciaio non passanti

NX-BF - Tasselli in acciaio non passante con barra filettata, dado e rondella

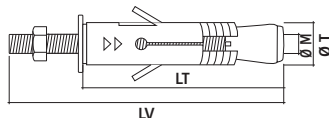

Codice	Descrizione	Ø M	LV mm	Ø T mm	LT mm	Scatola singola	Imballo complessivo
NB116	Tasselli in acciaio non passante NX-BF M6x45 barra filettata, dado e rondella	6	60	12	45	100 pz	5 Scatole
NB161	Tasselli in acciaio non passante NX-BF M8x55 barra filettata, dado e rondella	8	80	14	55	50 pz	5 Scatole
NB130	Tasselli in acciaio non passante NX-BF M8x65 barra filettata, dado e rondella	8	100	16	65	50 pz	5 Scatole
NB147	Tasselli in acciaio non passante NX-BF M10x75 barra filettata, dado e	10	85	20	75	40 pz	5 Scatole
NB154	Tasselli in acciaio non passante NX-BF M12x90 barra filettata, dado e	12	110	24	90	20 pz	5 Scatole

NX-OA - Tasselli in acciaio non passante con pitoneria occhio aperto

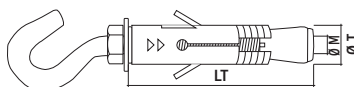

Codice	Descrizione	Ø V mm	LT mm	Ø T mm	Scatola singola	Imballo complessivo
NB222	Tasselli in acciaio non passante NX-OA M6x45 occhio aperto	6	45	12	50 pz	5 Scatole
NB239	Tasselli in acciaio non passante NX-OA M8x55 occhio aperto	8	55	14	40 pz	5 Scatole
NB246	Tasselli in acciaio non passante NX-OA M10x65 occhio aperto	10	65	16	25 pz	5 Scatole
NB253	Tasselli in acciaio non passante NX-OA M12x75 occhio aperto	12	75	20	10 pz	5 Scatole
NB260	Tasselli in acciaio non passante NX-OA M16x90 occhio aperto	16	90	24	10 pz	5 Scatole

NX-OC - Tasselli in acciaio non passante con pitoneria occhio chiuso stampato a freddo

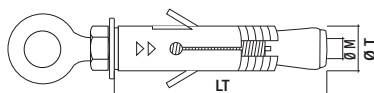

Codice	Descrizione	Ø M	LT mm	Ø T mm	Scatola singola	Imballo complessivo
NB178	Tasselli in acciaio non passante NX-OC M6x45 occhio chiuso	6	45	12	50 pz	5 Scatole
NB185	Tasselli in acciaio non passante NX-OC M8x55 occhio chiuso	8	55	14	50 pz	5 Scatole
NB192	Tasselli in acciaio non passante NX-OC M10x65 occhio chiuso	10	65	16	25 pz	5 Scatole
NB208	Tasselli in acciaio non passante NX-OC M12x75 occhio chiuso	12	75	20	15 pz	5 Scatole
NB215	Tasselli in acciaio non passante NX-OC M16x90 occhio chiuso	16	90	24	10 pz	5 Scatole

Disponibile in blister

Tasselli in acciaio non passanti
MATERIALI DI SUPPORTO CALCESTRUZZO, PIETRA NATURALE, MATTONI PIENI, MATTONE CLS PIENO

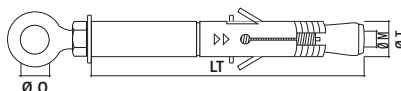
NX-OCPS - Tasselli in acciaio passante con occhiolo chiuso stampato a freddo

Codice	Descrizione	Ø T mm	LT mm	Ø foro mm	Scatola singola	Imballo complessivo
NB197	Tassello in acciaio non passante NX-OCPS M10x95 con occhiolo	10	95	16	25 pz	3 Scatole

NX-OCS - Tasselli in acciaio passante con occhiolo saldato

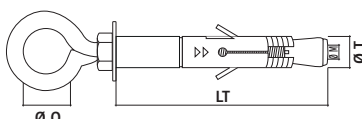
 DIPARTIMENTO
INGEGNERIA
CIVILE
ARCHITETTURA **dicaR**

Codice	Descrizione	Ø T mm	LT mm	Ø 0 mm	Scatola singola	Imballo complessivo
NB102168	Tassello in acciaio passante NX-OCS M10x65	10	65	23	25 pz	5 Scatole
NB102169	Tassello in acciaio passante NX-OCS M10x95	10	95	23	25 pz	5 Scatole
NB102170	Tassello in acciaio passante NX-OCS M10x115	10	115	23	20 pz	5 Scatole

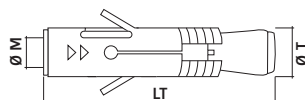
NXX - Tassello in acciaio inox A2 AISI 304 solo corpo

Codice	Descrizione	Ø M	LT mm	Ø T mm	Scatola singola	Imballo complessivo
NB2042	Tassello in acciaio inox A2 NXX M6x45	6	45	12	100 pz	5 Scatole
NB2059	Tassello in acciaio inox A2 NXX M8x55	8	55	14	50 pz	5 Scatole
NB2066	Tassello in acciaio inox A2 NXX M10x65	10	65	16	50 pz	5 Scatole
NB73875	Tassello in acciaio inox A2 NXX M12x75	12	75	20	25 pz	5 Scatole

Tasselli in acciaio non passanti

NXX-BX - Tasselli in acciaio Inox A2 AISI 304 con vite TE in A2 e rondella inox

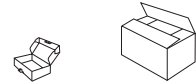
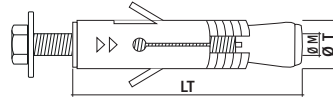

Codice	Descrizione	Ø M	LT mm	Ø T mm	Scatola singola	Imballo complessivo
NB2073	Tasselli in acciaio Inox A2 NXX-BX M6x45 con vite TE e rondella inox	6	45	12	50 pz	5 Scatole
NB2080	Tasselli in acciaio Inox A2 NXX-BX M8x55 con vite TE e rondella inox	8	55	14	50 pz	5 Scatole
NB2097	Tasselli in acciaio Inox A2 NXX-BX M10x65 con vite TE e rondella inox	10	65	16	40 pz	5 Scatole
NB73882	Tasselli in acciaio Inox A2 NXX-BX M12x75 con vite TE e rondella inox	12	75	20	20 pz	5 Scatole

Installazione di arredi urbani



Tasselli in acciaio non passanti

Ancoraggio in acciaio non passante, ad espansione per calcestruzzo non fessurato, idoneo per applicazioni su materiali compatti per carichi di elevata portata. Indicati per carpenteria pesante, strutture provvisorie, scaffalature metalliche, tende da sole, ancoraggi di impianti di condizionamento, idraulici ed elettrici, mensole, strutture porta-cavi, scale antincendio e di sicurezza macchinari, strutture per facciate ventilate, segnaletica stradale, profili, ecc...

MATERIALI DI SUPPORTO CALCESTRUZZO, PIETRA NATURALE, MATTONI PIENI, MATTONE CLS PIENO

HSP - Tasselli in acciaio non passante solo corpo

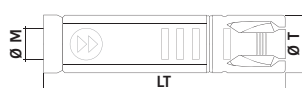

Codice	Descrizione	Ø M	LT mm	Ø T mm	Scatola singola	Imballo complessivo
NB60196	Tassello in acciaio non passante HSP M6x40	6	40	10	100 pz	5 Scatole
NB60202	Tassello in acciaio non passante HSP M8x50	8	50	14	50 pz	5 Scatole
NB60219	Tassello in acciaio non passante HSP M10x60	10	60	16	50 pz	5 Scatole
NB60226	Tassello in acciaio non passante HSP M12x80	12	80	20	25 pz	5 Scatole
NB60233	Tassello in acciaio non passante HSP M16x100	16	100	25	10 pz	5 Scatole

HSP-B - Tasselli in acciaio non passante con vite TE 8.8 e rondella

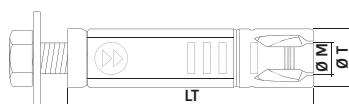

Codice	Descrizione	Ø M	LT mm	Ø T mm	Scatola singola	Imballo complessivo
NB64156	Tasselli in acciaio non passante HSP-B M6x50 con vite TE 8.8 e rondella	6	50	10	50 pz	5 Scatole
NB64163	Tasselli in acciaio non passante HSP-B M8x60 con vite TE 8.8 e rondella	8	60	14	50 pz	5 Scatole
NB64170	Tasselli in acciaio non passante HSP-B M10x70 con vite TE 8.8 e rondella	10	70	16	25 pz	5 Scatole
NB64187	Tasselli in acciaio non passante HSP-B M12x100 con vite TE 8.8 e rondella	12	100	20	20 pz	5 Scatole
NB64194	Tasselli in acciaio non passante HSP-B M16x130 con vite TE 8.8 e rondella	16	130	25	15 pz	5 Scatole

Tasselli in acciaio non passanti

HSP-OA - Tasselli in acciaio non passante occhiolo aperto stampato a freddo

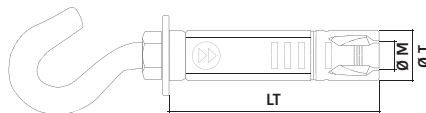

Codice	Descrizione	Ø M	LT mm	Ø T mm	Scatola singola	Imballo complessivo
NB789	Tassello in acciaio non passante HSP-OA M6x40 con occhiolo aperto	6	40	10	50 pz	5 Scatole
NB796	Tassello in acciaio non passante HSP-OA M8x50 con occhiolo aperto	8	50	14	50 pz	5 Scatole
NB802	Tassello in acciaio non passante HSP-OA M10x60 con occhiolo aperto	10	60	16	25 pz	5 Scatole
NB819	Tassello in acciaio non passante HSP-OA M12x80 con occhiolo aperto	12	80	20	10 pz	5 Scatole

HSP-OC - Tasselli in acciaio passante con occhiolo chiuso stampato a freddo

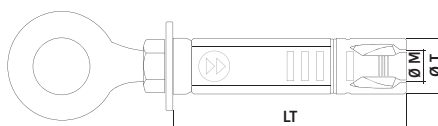

Codice	Descrizione	Ø M	LT mm	Ø T mm	Scatola singola	Imballo complessivo
NB826	Tassello in acciaio non passante HSP-OC M6x40 con occhiolo chiuso	6	40	10	50 pz	5 Scatole
NB833	Tassello in acciaio non passante HSP-OC M8x50 con occhiolo chiuso	8	50	14	50 pz	5 Scatole
NB840	Tassello in acciaio non passante HSP-OC M10x60 con occhiolo chiuso	10	60	16	25 pz	5 Scatole
NB857	Tassello in acciaio non passante HSP-OC M12x80 con occhiolo chiuso	12	80	20	10 pz	5 Scatole

Tasselli in Zamak non passanti

Ancoraggio in lega di Zamak non passante ad espansione, idoneo per applicazioni su materiali compatti, per carichi di elevata portata. Indicato per carpenteria pesante, strutture provvisorie, scaffalature metalliche, tende da sole, ancoraggi di impianti di condizionamento, idraulici ed elettrici, mensole, strutture porta-cavi, scale antincendio e di sicurezza macchinari, strutture per facciate ventilate, segnaletica stradale, profili.

MATERIALI DI SUPPORTO CALCESTRUZZO, PIETRA NATURALE, MATTONI PIENI, MATTONE CLS PIENO

HPM - Tasselli in zamak non passanti solo corpo

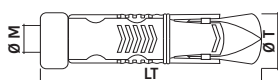

Codice	Descrizione	Ø M	LT mm	Ø T mm	Scatola singola	Imballo complessivo
NB864	Tassello in zamak HPM M6x45	6	45	12	100 pz	5 Scatole
NB871	Tassello in zamak HPM M8x50	8	50	14	50 pz	5 Scatole
NB888	Tassello in zamak HSP M10x60	10	60	16	50 pz	5 Scatole
NB895	Tassello in zamak HPM M12x70	12	70	20	25 pz	5 Scatole
NB901	Tassello in zamak HPM M16x115	16	115	25	15 pz	5 Scatole
NB918	Tassello in zamak HPM M20x130	20	130	32	8 pz	5 Scatole
NB925	Tassello in zamak HPM M24x140	24	140	38	6 pz	5 Scatole

HPM-B - Tasselli in zamak non passanti con vite TE 8.8 e rondella

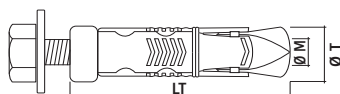

Codice	Descrizione	Ø M	LT mm	Ø T mm	Scatola singola	Imballo complessivo
NB932	Tassello HPM-B 12 in zamak M6x50 con vite TE 8.8 e rondella	6	50	12	100 pz	5 Scatole
NB949	Tassello HPM-B 14 in zamak M8x50 con vite TE 8.8 e rondella	8	50	14	50 pz	5 Scatole
NB956	Tassello HPM-B 16 in zamak M10x70 con vite TE 8.8 e rondella	10	70	16	40 pz	5 Scatole
NB963	Tassello HPM-B 20 in zamak M12x100 con vite TE 8.8 e rondella	12	100	20	20 pz	5 Scatole
NB970	Tassello HPM-B 25 in zamak M16x130 con vite TE 8.8 e rondella	16	130	25	10 pz	5 Scatole

Tasselli in Zamak non passanti

MATERIALI DI SUPPORTO CALCESTRUZZO, PIETRA NATURALE, MATTONI PIENI, MATTONE CLS PIENO

HPM-OA - Tasselli in zamak passanti con occhiolo aperto stampato a freddo

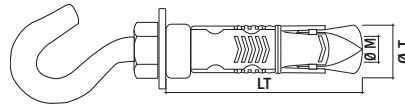

Codice	Descrizione	Ø M	LT mm	Ø T mm	Scatola singola	Imballo complessivo
NB3056	Tassello in zamak HPM-OA M6x45 con occhiolo aperto	6	45	12	50 pz	5 Scatole
NB3063	Tassello in zamak HPM-OA M8x50 con occhiolo aperto	8	50	14	50 pz	5 Scatole
NB3070	Tassello in zamak HPM-OA M10x60 con occhiolo aperto	10	60	16	25 pz	5 Scatole
NB3087	Tassello in zamak HPM-OA M12x70 con occhiolo aperto	12	70	20	10 pz	5 Scatole

HPM-OC - Tasselli in zamak passanti con occhiolo chiuso stampato a freddo

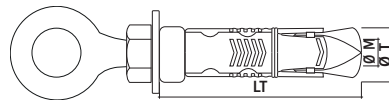

Codice	Descrizione	Ø M	LT mm	Ø T mm	Scatola singola	Imballo complessivo
NB3094	Tasselli in zamak HPM-OC M6x45 con occhiolo chiuso	6	45	12	50 pz	5 Scatole
NB3100	Tasselli in zamak HPM-OC M8x50 con occhiolo chiuso	8	50	14	50 pz	5 Scatole
NB3117	Tasselli in zamak HPM-OC M10x60 con occhiolo chiuso	10	60	16	25 pz	5 Scatole
NB3124	Tasselli in zamak HPM-OC M12x70 con occhiolo chiuso	12	70	20	15 pz	5 Scatole

HPM-BX - Tasselli in zamak passanti con vite AISI 304 - A2 e rondella

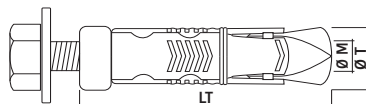

Codice	Descrizione	Ø M	LT mm	Ø T mm	Scatola singola	Imballo complessivo
NB1007	Tasselli in zamak HPM-BX M6x60 con vite e rondella	6	60	12	100 pz	5 Scatole
NB1014	Tasselli in zamak HPM-BX M8x80 con vite e rondella	8	80	14	50 pz	5 Scatole
NB1021	Tasselli in zamak HPM-BX M10x85 con vite e rondella	10	85	16	40 pz	5 Scatole
NB1038	Tasselli in zamak HPM-BX M12x110 con vite e rondella	12	110	20	20 pz	5 Scatole

Tasselli in acciaio non passanti

MATERIALI DI SUPPORTO CALCESTRUZZO, PIETRA NATURALE, MATTONI PIENI, MATTONE CLS PIENO

SXPX - Tasselli non passanti in acciaio inox A2

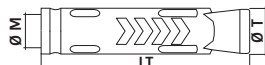

Codice	Descrizione	Ø M	LT mm	Ø T mm	Scatola singola	Imballo complessivo
NB2974	Tassello non passante SXPX 6x45 in acciaio inox A2	6	45	10	100 pz	10 Scatole
NB2981	Tassello non passante SXPX 8x50 in acciaio inox A2	8	50	12	100 pz	5 Scatole
NB2998	Tassello non passante SXPX 10x60 in acciaio inox A2	10	60	15	50 pz	5 Scatole
NB3001	Tassello non passante SXPX 12x75 in acciaio inox A2	12	75	18	50 pz	5 Scatole

*Disponibili a richiesta in acciaio inox A4

SXPX-BX - Tasselli non passanti in acciaio inox A2 con vite TE e rondella

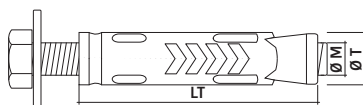

Codice	Descrizione	Ø M	LT mm	Ø T mm	Scatola singola	Imballo complessivo
NB3018	Tassello non passante SXPX-BX M6x60 inox A2 con vite TE e rondella	6	60	10	100 pz	5 Scatole
NB3025	Tassello non passante SXPX-BX M8x60 inox A2 con vite TE e rondella	8	60	12	50 pz	5 Scatole
NB3032	Tassello non passante SXPX-BX M10x70 inox A2 con vite TE e rondella	10	70	15	25 pz	5 Scatole
NB3049	Tassello non passante SXPX-BX M12x100 inox A2 con vite TE e rondella	12	100	18	25 pz	5 Scatole

*Disponibili a richiesta in acciaio inox A4

SXP CE - Tasselli non passanti in acciaio solo corpo

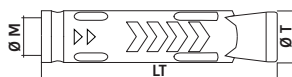

Codice	Descrizione	Ø M	LT mm	Ø T mm	Scatola singola	Imballo complessivo
NB98953	Tassello non passante in acciaio SXP CE M6x45	6	45	10	100 pz	10 Scatole
NB98960	Tassello non passante in acciaio SXP CE M8x50	8	50	12	100 pz	5 Scatole
NB98977	Tassello non passante in acciaio SXP CE M10x60	10	60	14	50 pz	5 Scatole
NB98984	Tassello non passante in acciaio SXP CE M12x75	12	75	18	50 pz	5 Scatole

Tasselli in acciaio non passanti

SXP-B CE - Tasselli non passanti in acciaio con vite TE 8.8 e rondella

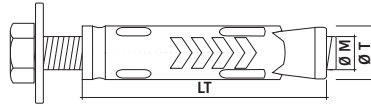

Codice	Descrizione	Ø M	LT mm	Ø T mm	Scatola singola	Imballo complessivo
NB98991	Tassello non passanti in acciaio SXP-B CE M6x50 con vite TE e rondella	6	50	10	100 pz	5 Scatole
NB99004	Tassello non passanti in acciaio SXP-B CE M 8x60 con vite TE e rondella	8	60	12	50 pz	5 Scatole
NB99011	Tassello non passanti in acciaio SXP-B CE M 10x70 con vite TE e rondella	10	70	14	25 pz	5 Scatole
NB99028	Tassello non passanti in acciaio SXP-B CE M 12x100 con vite TE e rondella	12	100	18	20 pz	5 Scatole

SXPX CE - Tasselli non passanti in acciaio inox A4 solo corpo

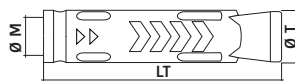

Codice	Descrizione	Ø M	LT mm	Ø T mm	Scatola singola	Imballo complessivo
NB99035	Tassello non passante SXPX CE M6x45 in acciaio inox A4	6	45	10	100 pz	10 Scatole
NB99042	Tassello non passante SXPX A4 CE M8x50 in acciaio inox A4	8	50	12	100 pz	5 Scatole
NB99059	Tassello non passante SXPX A4 CE M10x60 in acciaio inox A4	10	60	14	50 pz	5 Scatole
NB99066	Tassello non passante SXPX A4 CE M12x75 in acciaio inox A4	12	75	18	50 pz	5 Scatole

SXPX-BX CE - Tasselli non passanti in acciaio inox A4 con vite TE e rondella

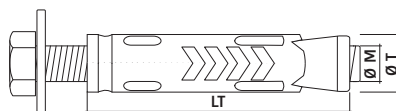

Codice	Descrizione	Ø M	LT mm	Ø T mm	Scatola singola	Imballo complessivo
NB99073	Tassello non passante SXPX-BX CE M6x45 inox A2 con vite TE e rondella	6	55	10	100 pz	5 Scatole
NB99080	Tassello non passante SXPX-BX CE M8x50 inox A2 con vite TE e rondella	8	65	12	50 pz	5 Scatole
NB99097	Tassello non passante SXPX-BX CE M10x60 inox A2 con vite TE e rondella	10	80	14	25 pz	5 Scatole
NB99103	Tassello non passante SXPX-BX CE M12x75 inox A2 con vite TE e rondella	12	100	18	25 pz	5 Scatole

Tasselli in acciaio non passanti

Ancorante in acciaio non passante ad espansione a più settori idoneo per applicazioni su materiali compatti per carichi di media portata. Indicato per carpenteria pesante, strutture provvisionali, scaffalature metalliche, tende da sole, ancoraggi di impianti di condizionamento, idraulici ed elettrici, mensole, strutture porta-cavi, scale antincendio e di sicurezza, cancelli e inferriate, macchinari, strutture per facciate ventilate, segnaletica stradale, profili, ecc...

MATERIALI DI SUPPORTO CALCESTRUZZO, PIETRA NATURALE, MATTONI PIENI, MATTONE CLS PIENO

SXP - Tassello in acciaio non passante

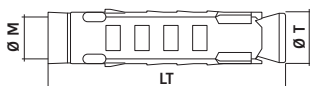

Codice	Descrizione	Ø M	LT mm	Ø T mm	Scatola singola	Imballo complessivo
NB1410	Tassello in acciaio non passante SXP M6x45	6	45	10	100 pz	10 Scatole
NB1427	Tassello in acciaio non passante SXP M8x50	8	50	12	100 pz	5 Scatole
NB1434	Tassello in acciaio non passante SXP M10x60	10	60	15	50 pz	5 Scatole
NB1441	Tassello in acciaio non passante SXP M12x75	12	75	18	50 pz	5 Scatole

Confezioni industriali



Codice	Descrizione	Ø M mm	LT mm	Ø T mm	Scatola singola
NB87155	Bulk tassello in acciaio non passante SXP M6x45	6	45	10	1.000 pz
NB87162	Bulk tassello in acciaio non passante SXP M8x50	8	50	12	500 pz
NB87179	Bulk tassello in acciaio non passante SXP M10x60	10	60	15	500 pz
NB87186	Bulk tassello in acciaio non passante SXP M12x75	12	75	18	250 pz

SXP-B - Tasselli in acciaio non passante completi di vite TE 8.8 e rondella

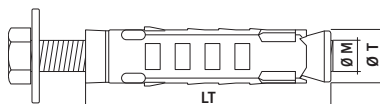

Codice	Descrizione	Ø M	LT mm	Ø T mm	Scatola singola	Imballo complessivo
NB1458	Tassello in acciaio non passante SXP-B 6x45 con vite TE e rondella	6	45	10	100 pz	5 Scatole
NB1465	Tassello in acciaio non passante SXP-B 8x50 con vite TE e rondella	8	50	12	50 pz	5 Scatole
NB1472	Tassello in acciaio non passante SXP-B 10x60 con vite TE e rondella	10	60	15	40 pz	5 Scatole
NB1489	Tassello in acciaio non passante SXP-B 12x75 con vite TE e rondella	12	75	18	20 pz	5 Scatole



Disponibile in blister



Disponibile in secchiello

Tasselli in acciaio passanti

SXP-BF - Tasselli in acciaio non passante con barra filettata, dado e rondella

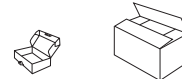
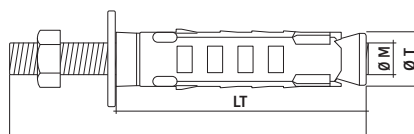

Codice	Descrizione	Ø M	LV mm	Ø T mm	LT mm	Scatola singola	Imballo complessivo
NB33602	Tassello in acciaio non passante SXP-BF M6x45 barra filettata, dado e rondella	6	60	10	45	100 pz	5 Scatole
NB33619	Tassello in acciaio non passante SXP-BF M8x50 barra filettata, dado e rondella	8	80	12	50	50 pz	5 Scatole
NB33626	Tassello in acciaio non passante SXP-BF M10x60 barra filettata, dado e rondella	10	85	15	60	40 pz	5 Scatole
NB33633	Tassello in acciaio non passante SXP-BF M12x75 barra filettata, dado e rondella	12	100	18	75	25 pz	5 Scatole

SXP-OA - Tasselli in acciaio non passante con occhiolo aperto stampato a freddo

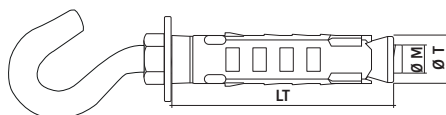

Codice	Descrizione	Ø M	LT mm	Ø T mm	Scatola singola	Imballo complessivo
NB3254	Tassello in acciaio passante SXP-OA M6x45 occhiolo aperto	6	45	10	50 pz	5 Scatole
NB3261	Tassello in acciaio passante SXP-OA M8x50 occhiolo aperto	8	50	12	50 pz	5 Scatole
NB3278	Tassello in acciaio passante SXP-OA M10x60 occhiolo aperto	10	60	15	25 pz	5 Scatole
NB3285	Tassello in acciaio passante SXP-OA M12x75 occhiolo aperto	12	75	18	15 pz	5 Scatole

Disponibile in blister
 Disponibile in secchiello

SXP-OC - Tasselli in acciaio passante con occhiolo chiuso stampato a freddo

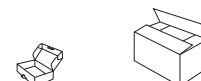
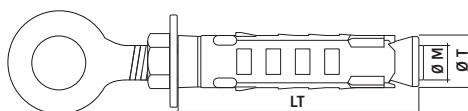

Codice	Descrizione	Ø M	LT mm	Ø T mm	Scatola singola	Imballo complessivo
NB3216	Tassello in acciaio passante SXP-OC M6x45 occhiolo aperto	6	45	10	50 pz	5 Scatole
NB3223	Tassello in acciaio passante SXP-OC M8x50 occhiolo aperto	8	50	12	50 pz	5 Scatole
NB3230	Tassello in acciaio passante SXP-OC M10x60 occhiolo aperto	10	60	15	25 pz	5 Scatole
NB3247	Tassello in acciaio passante SXP-OC M12x75 occhiolo aperto	12	75	18	15 pz	5 Scatole

Disponibile in blister
 Disponibile in secchiello

Tasselli in acciaio passanti

SXP-SV - Tasselli in acciaio passante con vite TSEI esagono incassato 10.9

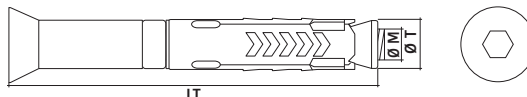

Codice	Descrizione	Ø M	LT mm	Ø T mm	Scatola singola	Imballo complessivo
NB95587	Tassello in acciaio passante SXP-SV M6x80 con vite TSEI	6	80	10	50 pz	5 Scatole
NB95594	Tassello in acciaio passante SXP-SV M8x90 con vite TSEI	8	90	12	50 pz	5 Scatole
NB95600	Tassello in acciaio passante SXP-SV M10x110 con vite TSEI	10	110	14	50 pz	5 Scatole
NB95617	Tassello in acciaio passante SXP-SV M12x115 con vite TSEI	12	115	18	10 pz	5 Scatole

SXP-P - Tasselli in acciaio passante con distanziale, rondella e vite TE 8.8

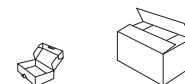
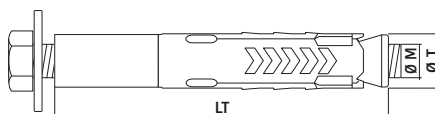

Codice	Descrizione	Ø M	LT mm	Ø T mm	Scatola singola	Imballo complessivo
NB33688	Tasselli in acciaio passante SXP-P M6x65 con distanziale, rondella e vite TE	6	65	10	50 pz	5 Scatole
NB33695	Tasselli in acciaio passante SXP-P M8x70 con distanziale, rondella e vite TE	8	70	12	50 pz	5 Scatole
NB33701	Tasselli in acciaio passante SXP-P M10x90 con distanziale, rondella e vite TE	10	90	14	25 pz	5 Scatole
NB33718	Tasselli in acciaio passante SXP-P M12x100 con distanziale, rondella e vite TE	12	100	18	15 pz	5 Scatole

Disponibile in blister

SXP-TAPR - Tasselli in acciaio passante con vite testa asportabile

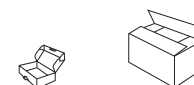
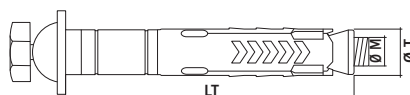

Codice	Descrizione	Ø M	LT mm	Ø T mm	Scatola singola	Imballo complessivo
NB44875	Tasselli in acciaio passante SXP-TAPR M8x75 con vite testa asportabile	8	75	12	50 pz	5 Scatole
NB44882	Tasselli in acciaio passante SXP-TAPR M8x95 con vite testa asportabile	8	95	12	50 pz	5 Scatole



▲
Installazione insegne, segnaletica e arredo urbano

Installazione parapetti, ringhiere e serramenti



Tasselli in acciaio passanti

Tassello in acciaio passante omologato ETA per calcestruzzo non fessurato, idoneo per parapetti, travi di acciaio macchine utensili, impianti industriali costruzioni metalliche pesanti, blindosbarre, camminamenti sospesi e quadri elettrici industriali.

MATERIALI DI SUPPORTO CALCESTRUZZO, PIETRA NATURALE, MATTONI PIENI, MATTONE CLS PIENO

SXC - Tasselli in acciaio passanti completi di dado esagonale cieco

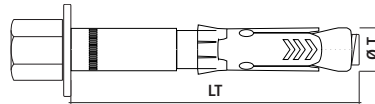

Codice	Descrizione	Ø T mm	LT mm	Scatola singola	Imballo complessivo
NB1199	Tasselli in acciaio passanti SXC 8/15-70 con dado esagonale cieco	8	70	100 pz	5 Scatole
NB1212	Tasselli in acciaio passanti SXC 10/15-85 con dado esagonale cieco	10	85	50 pz	5 Scatole
NB1229	Tasselli in acciaio passanti SXC 10/50-120 con dado esagonale cieco	10	120	50 pz	5 Scatole
NB1236	Tasselli in acciaio passanti SXC 12/15-100 con dado esagonale cieco	12	100	50 pz	5 Scatole
NB1243	Tasselli in acciaio passanti SXC 12/50-135 con dado esagonale cieco	12	135	50 pz	5 Scatole
NB1246	Tasselli in acciaio passanti SXC 14/20-115 con dado esagonale cieco	14	115	50 pz	5 Scatole
NB1249	Tasselli in acciaio passanti SXC 14/50-145 con dado esagonale cieco	14	145	50 pz	5 Scatole
NB1255	Tasselli in acciaio passanti SXC 16/40-150 con dado esagonale cieco	16	150	50 pz	5 Scatole
NB1252	Tasselli in acciaio passanti SXC 16/20-130 con dado esagonale cieco	16	130	15 pz	5 Scatole

SKB - Tasselli in acciaio passanti con vite TE 8.8



Sismica
Cat. C1-C2

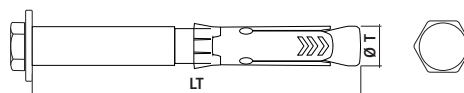

Codice	Descrizione	Ø T mm	LT mm	Scatola singola	mballo complessivo
NB91150	Tasselli in acciaio passanti SKB 12/10-80 con vite TE	12	80	25 pz	5 Scatole
NB91153	Tasselli in acciaio passanti SKB 12/20-90 con vite TE	12	90	25 pz	5 Scatole
NB91156	Tasselli in acciaio passanti SKB 12/50-120 con vite TE	12	120	25 pz	5 Scatole
NB91159	Tasselli in acciaio passanti SKB 15/10-90 con vite TE	15	90	20 pz	5 Scatole
NB91162	Tasselli in acciaio passanti SKB 15/20-100 con vite TE	15	100	20 pz	5 Scatole
NB91165	Tasselli in acciaio passanti SKB 15/50-130 con vite TE	15	130	10 pz	5 Scatole
NB91168	Tasselli in acciaio passanti SKB 18/10-110 con vite TE	18	110	10 pz	5 Scatole
NB91171	Tasselli in acciaio passanti SKB 18/25-125 con vite TE	18	125	10 pz	5 Scatole
NB91174	Tasselli in acciaio passanti SKB 18/50-150 con vite TE	18	150	10 pz	5 Scatole
NB91177	Tasselli in acciaio passanti SKB 18/100-200 con vite TE	18	200	10 pz	5 Scatole
NB91180	Tasselli in acciaio passanti SKB 24/25-140 con vite TE	24	140	5 pz	5 Scatole
NB91183	Tasselli in acciaio passanti SKB 24/50-165 con vite TE	24	165	5 pz	5 Scatole

Tasselli in acciaio passanti

SKB-BF - Tasselli in acciaio passanti con vite TE 8.8 barra filettata e dado



Sismica
Cat. C1-C2

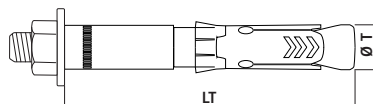

Codice	Descrizione	Ø T mm	LT mm	Scatola singola	Imballo complessivo
NB91190	Tassello in acciaio SKB-BF 12/10-80 con vite TE barra filettata e dado	12	80	25 pz	5 Scatole
NB91193	Tassello in acciaio SKB-BF 12/20-90 con vite TE barra filettata e dado	12	90	25 pz	5 Scatole
NB91196	Tassello in acciaio SKB-BF 12/50-120 con vite TE barra filettata e dado	12	120	25 pz	5 Scatole
NB91199	Tassello in acciaio SKB-BF 15/10-90 con vite TE barra filettata e dado	15	90	20 pz	5 Scatole
NB91202	Tassello in acciaio SKB-BF 15/20-100 con vite TE barra filettata e dado	15	100	20 pz	5 Scatole
NB91205	Tassello in acciaio SKB-BF 15/50-130 con vite TE barra filettata e dado	15	130	20 pz	5 Scatole
NB91208	Tassello in acciaio SKB-BF 18/10-110 con vite TE barra filettata e dado	18	110	10 pz	5 Scatole
NB91211	Tassello in acciaio SKB-BF 18/25-125 con vite TE barra filettata e dado	18	125	10 pz	5 Scatole
NB91214	Tassello in acciaio SKB-BF 18/50-150 con vite TE barra filettata e dado	18	150	10 pz	5 Scatole
NB91217	Tassello in acciaio SKB-BF 18/100-200 con vite TE barra filettata e dado	18	200	10 pz	5 Scatole
NB91220	Tassello in acciaio SKB-BF 24/25-140 con vite TE barra filettata e dado	24	140	5 pz	5 Scatole
NB91223	Tassello in acciaio SKB-BF 24/50-165 con vite TE barra filettata e dado	24	165	5 pz	5 Scatole

SKB-SV - Tasselli in acciaio passanti con vite TSEI esagono incassato 10.9

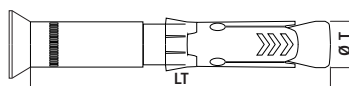

Codice	Descrizione	Ø T mm	LT mm	Scatola singola	Imballo complessivo
NB91230	Tassello passante SKB-SV 12/16-85 con vite TSEI esagono incassato	12	85	25 pz	5 Scatole
NB91233	Tassello passante SKB-SV 12/26-95 con vite TSEI esagono incassato	12	95	25 pz	5 Scatole
NB91236	Tassello passante SKB-SV 12/56-125 con vite TSEI esagono incassato	12	125	25 pz	5 Scatole
NB91239	Tassello passante SKB-SV 15/15-95 con vite TSEI esagono incassato	15	95	20 pz	5 Scatole
NB91242	Tassello passante SKB-SV 15/25-105 con vite TSEI esagono incassato	15	105	20 pz	5 Scatole
NB91245	Tassello passante SKB-SV 15/55-135 con vite TSEI esagono incassato	15	135	20 pz	5 Scatole
NB91248	Tassello passante SKB-SV 18/18-120 con vite TSEI esagono incassato	18	120	10 pz	5 Scatole
NB91251	Tassello passante SKB-SV 18/33-135 con vite TSEI esagono incassato	18	135	10 pz	5 Scatole

Tasselli in acciaio passanti

MATERIALI DI SUPPORTO CALCESTRUZZO, PIETRA NATURALE, MATTONI PIENI, MATTONE CLS PIENO

SXB - Tasselli in acciaio passanti con con vite TE 8.8

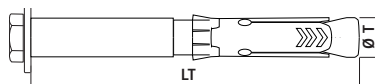

Codice	Descrizione	Ø T mm	LT mm	Busta singola	Imballo
NB61070	Tassello in acciaio passante SXB 6X70 con vite TE 8.8	6	70	50 pz	5 Scatole
NB61087	Tassello in acciaio passante SXB 6X80 con vite TE 8.8	6	80	50 pz	5 Scatole
NB1298	Tassello in acciaio passante SXB 8X80 con vite TE 8.8	8	80	50 pz	5 Scatole
NB1304	Tassello in acciaio passante SXB 8X90 con vite TE 8.8	8	90	50 pz	5 Scatole
NB61094	Tassello in acciaio passante SXB 8X120 con vite TE 8.8	8	120	25 pz	5 Scatole
NB1311	Tassello in acciaio passante SXB 10X90 con vite TE 8.8	10	90	25 pz	5 Scatole
NB1328	Tassello in acciaio passante SXB 10X100 con vite TE 8.8	10	100	25 pz	5 Scatole
NB61100	Tassello in acciaio passante SXB 10X130 con vite TE 8.8	10	130	25 pz	5 Scatole
NB1342	Tassello in acciaio passante SXB 12X110 con vite TE 8.8	12	110	10 pz	5 Scatole
NB1403	Tassello in acciaio passante SXB 12X125 con vite TE 8.8	12	125	10 pz	5 Scatole
NB61117	Tassello in acciaio passante SXB 12X150 con vite TE 8.8	12	150	10 pz	5 Scatole
NB1366	Tassello in acciaio passante SXB 16X140 con vite TE 8.8	12	140	5 pz	5 Scatole
NB61124	Tassello in acciaio passante SXB 16X165 con vite TE 8.8	12	165	5 pz	5 Scatole

SXB-BF - Tasselli in acciaio passanti distanziati con barra, dado e rondella

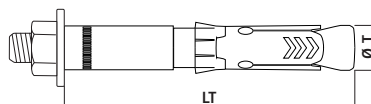

Codice	Descrizione	Ø T mm	LT mm	Scatola singola	Imballo complessivo
NB95624	Tassello in acciaio SXB-BF 6X70 con barra, dado e rondella	6	70	50 pz	5 Scatole
NB95631	Tassello in acciaio SXB-BF 6X80 con barra, dado e rondella	6	80	50 pz	5 Scatole
NB95648	Tassello in acciaio SXB-BF 6X110 con barra, dado e rondella	6	110	50 pz	5 Scatole
NB95655	Tassello in acciaio SXB-BF 8X80 con barra, dado e rondella	8	80	50 pz	5 Scatole
NB95662	Tassello in acciaio SXB-BF 8X90 con barra, dado e rondella	8	90	50 pz	5 Scatole
NB95679	Tassello in acciaio SXB-BF 8X120 con barra, dado e rondella	8	120	25 pz	5 Scatole
NB95686	Tassello in acciaio SXB-BF 10X90 con barra, dado e rondella	10	90	25 pz	5 Scatole
NB95693	Tassello in acciaio SXB-BF 10X100 con barra, dado e rondella	10	100	25 pz	5 Scatole
NB95709	Tassello in acciaio SXB-BF 10X130 con barra, dado e rondella	10	130	25 pz	5 Scatole
NB95716	Tassello in acciaio SXB-BF 12X110 con barra, dado e rondella	12	110	10 pz	5 Scatole
NB95723	Tassello in acciaio SXB-BF 12X125 con barra, dado e rondella	12	125	10 pz	5 Scatole
NB95730	Tassello in acciaio SXB-BF 12X150 con barra, dado e rondella	12	150	10 pz	5 Scatole
NB95747	Tassello in acciaio SXB-BF 12X200 con barra, dado e rondella	12	200	5 pz	5 Scatole
NB95754	Tassello in acciaio SXB-BF 16X140 con barra, dado e rondella	16	140	5 pz	5 Scatole
NB95761	Tassello in acciaio SXB-BF 16X165 con barra, dado e rondella	16	165	5 pz	5 Scatole

Tasselli in acciaio passanti distanziati

SXB-DC - Tasselli in acciaio passanti distanziati con barra e dado cilindrico cieco

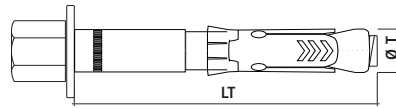

Codice	Descrizione	Ø T mm	LT mm	Scatola singola	Imballo
NB99835	Tasselli in acciaio passanti SXB-DC 10/10-70 con barra e dado esagonale cieco	10	70	50 pz	5 Scatole
NB99840	Tasselli in acciaio passanti SXB-DC 10/20-80 con barra e dado esagonale cieco	10	80	50 pz	5 Scatole
NB99845	Tasselli in acciaio passanti SXB-DC 10/50-110 con barra e dado esagonale cieco	10	110	50 pz	5 Scatole
NB99850	Tasselli in acciaio passanti SXB-DC 12/10-80 con barra e dado esagonale cieco	12	80	25 pz	5 Scatole
NB99855	Tasselli in acciaio passanti SXB-DC 12/20-90 con barra e dado esagonale cieco	12	90	25 pz	5 Scatole
NB99860	Tasselli in acciaio passanti SXB-DC 12/50-120 con barra e dado esagonale cieco	12	120	25 pz	5 Scatole
NB99865	Tasselli in acciaio passanti SXB-DC 15/10-90 con barra e dado esagonale cieco	15	90	20 pz	5 Scatole
NB99870	Tasselli in acciaio passanti SXB-DC 15/20-100 con barra e dado esagonale cieco	15	100	20 pz	5 Scatole
NB99875	Tasselli in acciaio passanti SXB-DC 15/50-130 con barra e dado esagonale cieco	15	130	20 pz	5 Scatole
NB99880	Tasselli in acciaio passanti SXB-DC 18/10-110 con barra e dado esagonale cieco	18	110	10 pz	5 Scatole
NB99885	Tasselli in acciaio passanti SXB-DC 18/25-125 con barra e dado esagonale cieco	18	125	10 pz	5 Scatole
NB99890	Tasselli in acciaio passanti SXB-DC 18/50-150 con barra e dado esagonale cieco	18	150	10 pz	5 Scatole
NB99895	Tasselli in acciaio passanti SXB-DC 18/100-200 con barra e dado esagonale cieco	18	200	10 pz	5 Scatole
NB99900	Tasselli in acciaio passanti SXB-DC 24/25-140 con barra e dado esagonale cieco	24	140	5 pz	5 Scatole
NB99910	Tasselli in acciaio passanti SXB-DC 24/50-165 con barra e dado esagonale cieco	24	165	5 pz	5 Scatole

Installazione canaline e camminamenti sospesi



Tasselli con filetto interno

Ancoraggio in acciaio non passante con filetto interno, ad espansione tramite punzone, per calcestruzzo non fessurato. Idoneo per applicazioni con carichi distanziati e/o di elementi in sospensione.

MATERIALI DI SUPPORTO CALCESTRUZZO, PIETRA NATURALE, MATTONI PIENI, MATTONE CLS PIENO

DROP IN - Per fissaggio pesante

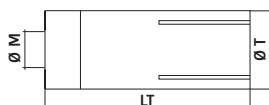

Codice	Descrizione	Ø M	LT mm	Ø T mm	Scatola singola	Imballo complessivo
NB53211	Tassello con filetto interno DROP IN M 6x25 E 8 per punzone	6	25	8	200 pz	10 Scatole
NB53228	Tassello con filetto interno DROP IN M 8x30 E 10 per punzone	8	30	10	100 pz	10 Scatole
NB53235	Tassello con filetto interno DROP IN M 10x40 E 12 per punzone	10	40	12	100 pz	5 Scatole
NB53242	Tassello con filetto interno DROP IN M 12x50 E 15 per punzone	12	50	15	50 pz	5 Scatole
NB53259	Tassello con filetto interno DROP IN M 16x65 E 20 per punzone	16	65	20	25 pz	5 Scatole

DROP SF CE7 - Per fissaggio pesante

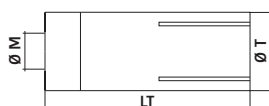

Codice	Descrizione	Ø M	LT mm	Ø T mm	Scatola singola	Imballo complessivo
NB2035	Tassello con filetto interno DROP SF CE7 M 6x25 E 8 per punzone	6	25	8	200 pz	10 Scatole
NB1991	Tassello con filetto interno DROP SF CE7 M 8x30 E 10 per punzone	8	30	10	100 pz	10 Scatole
NB2004	Tassello con filetto interno DROP SF CE7 M 10x40 E 12 per punzone	10	40	12	100 pz	5 Scatole
NB2011	Tassello con filetto interno DROP SF CE7 M 12x50 E 15 per punzone	12	50	15	50 pz	5 Scatole
NB2028	Tassello con filetto interno DROP SF CE7 M 16x65 E 20 per punzone	16	65	20	25 pz	5 Scatole



◀ Installazione distanziata di condizionatore a soffitto

Tasselli con filetto interno

DROP INOX - in acciaio Inox A4 per fissaggio pesante

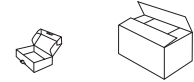
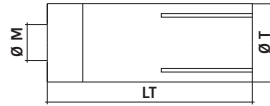

Codice	Descrizione	Ø M	LT mm	Ø T mm	Scatola singola	Imballo complessivo
NB2141	Tassello con filetto interno DROP IX M 6x25 E 8 per punzone	6	25	8	200 pz	10 Scatole
NB2158	Tassello con filetto interno DROP IX M 8x30 E 10 per punzone	8	30	10	100 pz	10 Scatole
NB2165	Tassello con filetto interno DROP IX M 10x40 E 12 per punzone	10	40	12	100 pz	5 Scatole
NB2189	Tassello con filetto interno DROP IX M 12x50 E 15 per punzone	12	50	15	50 pz	5 Scatole
NB2172	Tassello con filetto interno DROP IX M 16x65 E 20 per punzone	16	65	20	25 pz	5 Scatole

PUNZONE - per DROP

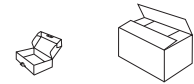

Per espandere il cono interno

Codice	Descrizione	Passo M	Scatola singola	Imballo complessivo
NB5463	Punzone M 6	6	1 pz	- Scatole
NB5470	Punzone M 8	8	1 pz	- Scatole
NB29742	Punzone M 10	10	1 pz	- Scatole
NB5487	Punzone M 12	12	1 pz	- Scatole
NB5494	Punzone M 16	16	1 pz	- Scatole

NTO - Tassello in ottone godronato per medie portate

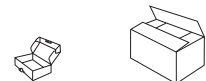
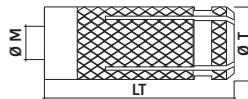

Codice	Descrizione	Ø M	LT mm	Ø T mm	Scatola singola	Imballo complessivo
NB75107	Tassello NTO in ottone M 5x20 E 6,5	5	20	6,5	200 pz	10 Scatole
NB75114	Tassello NTO in ottone M 6x23 E 8	6	23	8	300 pz	10 Scatole
NB75121	Tassello NTO in ottone M 8x28 E 10	8	28	10	300 pz	5 Scatole
NB1977	Tassello NTO in ottone M 10x32 E 12	10	32	12	100 pz	5 Scatole
NB1984	Tassello NTO in ottone M 12x38 E 15	12	38	15	100 pz	5 Scatole

Disponibile in blister

Tasselli in acciaio passanti

Tassello passante in acciaio leggero ad espansione per applicazioni su materiali compatti e semicompatti per carichi di media portata. Indicati per carpenteria metallica, strutture provvisorie, scaffalature industriali, tende da sole, ancoraggi di impianti di condizionamento, idraulici ed elettrici, mensole, scale, binari per ascensori, strutture porta cavi, cancelli e inferriate, segnaletica stradale, arredo urbano, serramenti, ecc..

MATERIALI DI SUPPORTO CALCESTRUZZO, PIETRA NATURALE, MATTONI PIENI, MATTONE CLS PIENO

SXL-V - Tassello in acciaio passante con vite TE 6.8

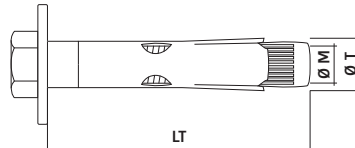

Codice	Descrizione	Ø M	LT mm	Ø T mm	Scatola singola	Imballo complessivo
NB1496	Tassello in acciaio passante SXL-V E8x45 con vite TE	6	45	8	100 pz	5 Scatole
NB1502	Tassello in acciaio passante SXL-V E8x60 con vite TE	6	60	8	100 pz	5 Scatole
NB1533	Tassello in acciaio passante SXL-V E10x60 con vite TE	8	60	10	50 pz	5 Scatole
NB1540	Tassello in acciaio passante SXL-V E10x80 con vite TE	8	80	10	50 pz	5 Scatole
NB1571	Tassello in acciaio passante SXL-V E12x70 con vite TE	10	70	12	50 pz	5 Scatole
NB1588	Tassello in acciaio passante SXL-V E12x100 con vite TE	10	100	12	25 pz	5 Scatole
NB1595	Tassello in acciaio passante SXL-V E14x75 con vite TE	10	75	14	40 pz	5 Scatole
NB1601	Tassello in acciaio passante SXL-V E14x100 con vite TE	10	100	14	25 pz	5 Scatole
NB1618	Tassello in acciaio passante SXL-V E16x80 con vite TE	12	80	16	25 pz	5 Scatole
NB1625	Tassello in acciaio passante SXL-V E16x110 con vite TE	12	110	16	25 pz	5 Scatole



Disponibile in blister



Disponibile in secchiello

SXL-OAF - Tasselli in acciaio passanti con gancio a filo

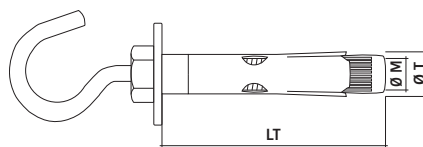

Codice	Descrizione	Ø M	LT mm	Ø T mm	Scatola singola	Imballo complessivo
NB52216	Tassello in acciaio passante SXL-OAF E8x45 con pitoneria gancio a filo	6	45	8	100 pz	5 Scatole
NB52225	Tassello in acciaio passante SXL-OAF E10x60 con pitoneria gancio a filo	8	60	10	50 pz	5 Scatole
NB52240	Tassello in acciaio passante SXL-OAF E12x70 con pitoneria gancio a filo	10	70	12	25 pz	5 Scatole
NB52250	Tassello in acciaio passante SXL-OAF E16x80 con pitoneria gancio a filo	12	80	16	25 pz	5 Scatole

Tasselli in acciaio passanti

SXL-OCF - Tasselli in acciaio passanti con occhiolo chiuso a filo

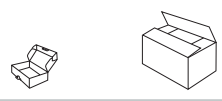
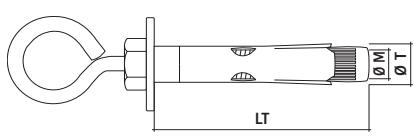

Codice	Descrizione	Ø M	LT mm	Ø T mm	Scatola singola	Imballo complessivo
NB52254	Tassello in acciaio passante SXL-OCF E8x45 con occhiolo chiuso a filo	6	45	8	100 pz	5 Scatole
NB52273	Tassello in acciaio passante SXL-OCF E10x60 con occhiolo chiuso a filo	8	60	10	50 pz	5 Scatole
NB52280	Tassello in acciaio passante SXL-OCF E12x70 con occhiolo chiuso a filo	10	70	12	25 pz	5 Scatole
NB52288	Tassello in acciaio passante SXL-OCF E16x80 con occhiolo chiuso a filo	12	80	16	25 pz	5 Scatole

SXLV-GL - Tasselli in acciaio passanti con codetta a L

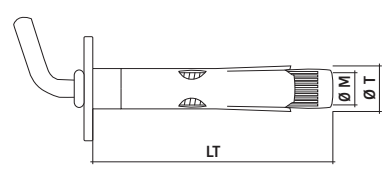

Codice	Descrizione	Ø M	LT mm	Ø T mm	Scatola singola	Imballo complessivo
NB34180	Tassello in acciaio passante SXLV-GL 8x80 con con codetta a	10	80	8	50 pz	5 Scatole

Disponibile in blister

SXL-INV - Tasselli in acciaio passanti con impronta Torx T40

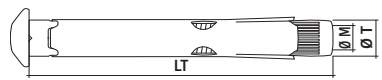

Codice	Descrizione	Ø M	LT mm	Ø T mm	Scatola singola	Imballo complessivo
NB44899	Tassello in acciaio passante SXL-INV 8x60 con vite T40 antintrusione	8	60	10	100 pz	5 Scatole
NB44905	Tassello in acciaio passante SXL-INV 8x80 con vite T40 antintrusione	8	80	10	100 pz	5 Scatole
NB74179	Impronta Torx inviolabile T40	-	-	-	100 pz	10 Scatole

Tasselli in acciaio passanti

Tassello in acciaio passante in lamierino ad espansione per applicazioni su materiali compatti e semicompatti per carichi di media portata. Indicati per carpenteria metallica, strutture provvisorie, scaffalature industriali, tende da sole, ancoraggi di impianti di condizionamento, idraulici ed elettrici...

MATERIALI DI SUPPORTO CALCESTRUZZO, PIETRA NATURALE, MATTONI PIENI, MATTONE CLS PIENO

DIBOLT - Tasselli in acciaio passanti con vite TE 6.8

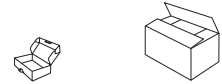
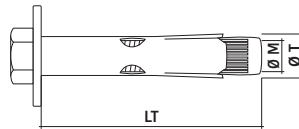

Codice	Descrizione	Ø M	LT mm	Ø T mm	Scatola singola	Imballo complessivo
NB61582	Tassello in acciaio passante DIBOLT E8x50 con vite TE 6.8	6	50	8	100 pz	5 Scatole
NB61599	Tassello in acciaio passante DIBOLT E8x70 con vite TE 6.8	6	70	8	100 pz	5 Scatole
NB61605	Tassello in acciaio passante DIBOLT E10x55 con vite TE 6.8	8	55	10	50 pz	5 Scatole
NB61612	Tassello in acciaio passante DIBOLT E10x75 con vite TE 6.8	8	75	10	50 pz	5 Scatole
NB61629	Tassello in acciaio passante DIBOLT E10x100 con vite TE 6.8	8	100	10	50 pz	5 Scatole
NB61636	Tassello in acciaio passante DIBOLT E10x120 con vite TE 6.8	8	120	10	50 pz	5 Scatole
NB61643	Tassello in acciaio passante DIBOLT E12x65 con vite TE 6.8	10	65	12	50 pz	5 Scatole
NB61650	Tassello in acciaio passante DIBOLT E12x80 con vite TE 6.8	10	80	12	50 pz	5 Scatole
NB61667	Tassello in acciaio passante DIBOLT E12x100 con vite TE 6.8	10	100	12	50 pz	5 Scatole
NB61674	Tassello in acciaio passante DIBOLT E12x120 con vite TE 6.8	10	120	12	50 pz	5 Scatole

DIBOLT CE - Tasselli in acciaio passanti con vite TE 8.8



ETAG 001-02 per uso su calcestruzzo non fessurato (cen/ts 1992-4 Metodo A)

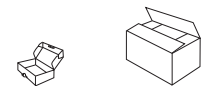
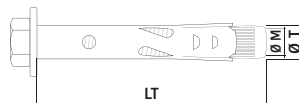

Codice	Descrizione	Ø M	LT mm	Ø T mm	Scatola singola	Imballo complessivo
NB121000	Tassello in acciaio passante DIBOLT E8x65 con vite TE 8.8 cert. ETAG CE	6	65	8	100 pz	4 Scatole
NB121001	Tassello in acciaio passante DIBOLT E8x100 con vite TE 8.8 cert. ETAG CE	6	100	8	100 pz	4 Scatole
NB121002	Tassello in acciaio passante DIBOLT E10x70 con vite TE 8.8 cert. ETAG CE	8	70	10	50 pz	6 Scatole
NB121003	Tassello in acciaio passante DIBOLT E10x100 con vite TE 8.8 cert. ETAG CE	8	100	10	50 pz	6 Scatole
NB121004	Tassello in acciaio passante DIBOLT E10x120 con vite TE 8.8 cert. ETAG CE	8	120	10	50 pz	4 Scatole
NB121005	Tassello in acciaio passante DIBOLT E12x80 con vite TE 8.8 cert. ETAG CE	10	80	12	50 pz	4 Scatole
NB121006	Tassello in acciaio passante DIBOLT E12x100 con vite TE 8.8 cert. ETAG CE	10	100	12	50 pz	2 Scatole
NB121007	Tassello in acciaio passante DIBOLT E12x120 con vite TE 8.8 cert. ETAG CE	10	120	12	50 pz	2 Scatole
NB121008	Tassello in acciaio passante DIBOLT E16x90 con vite TE 8.8 cert. ETAG CE	12	90	16	25 pz	2 Scatole
NB121009	Tassello in acciaio passante DIBOLT E16x110 con vite TE 8.8 cert. ETAG CE	12	110	16	25 pz	2 Scatole
NB121010	Tassello in acciaio passante DIBOLT E16x130 con vite TE 8.8 cert. ETAG CE	12	130	16	25 pz	2 Scatole

DIBOLT - Tasselli in acciaio passanti con vite TE 8.8

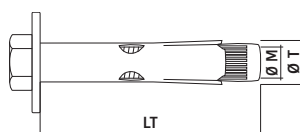

Codice	Descrizione	Ø M	LT mm	Ø T mm	Scatola singola	Imballo complessivo
NB61700	Tassello in acciaio passante DIBOLT E8x50 con vite TE 8.8	6	50	8	100 pz	5 Scatole
NB61705	Tassello in acciaio passante DIBOLT E8x70 con vite TE 8.8	6	70	8	100 pz	5 Scatole
NB61707	Tassello in acciaio passante DIBOLT E8x90 con vite TE 8.8	6	90	8	50 pz	5 Scatole
NB61710	Tassello in acciaio passante DIBOLT E10x55 con vite TE 8.8	8	55	10	50 pz	5 Scatole
NB61715	Tassello in acciaio passante DIBOLT E10x75 con vite TE 8.8	8	75	10	50 pz	5 Scatole
NB61720	Tassello in acciaio passante DIBOLT E10x100 con vite TE 8.8	8	100	10	50 pz	5 Scatole
NB61725	Tassello in acciaio passante DIBOLT E10x120 con vite TE 8.8	8	120	10	50 pz	5 Scatole
NB61748	Tassello in acciaio passante DIBOLT E10x140 con vite TE 8.8	8	140	10	50 pz	5 Scatole
NB61730	Tassello in acciaio passante DIBOLT E12x65 con vite TE 8.8	10	65	12	50 pz	5 Scatole
NB61735	Tassello in acciaio passante DIBOLT E12x80 con vite TE 8.8	10	80	12	50 pz	5 Scatole
NB61740	Tassello in acciaio passante DIBOLT E12x100 con vite TE 8.8	10	100	12	50 pz	5 Scatole
NB61745	Tassello in acciaio passante DIBOLT E12x120 con vite TE 8.8	10	120	12	50 pz	5 Scatole
NB61757	Tassello in acciaio passante DIBOLT E14x80 con vite TE 8.8	10	80	14	50 pz	5 Scatole
NB61759	Tassello in acciaio passante DIBOLT E14x100 con vite TE 8.8	10	100	14	40 pz	5 Scatole
NB61762	Tassello in acciaio passante DIBOLT E14x120 con vite TE 8.8	10	120	14	30 pz	5 Scatole
NB61768	Tassello in acciaio passante DIBOLT E14x140 con vite TE 8.8	10	140	14	40 pz	5 Scatole
NB61772	Tassello in acciaio passante DIBOLT E16x 80 con vite TE 8.8	12	80	16	30 pz	5 Scatole
NB61774	Tassello in acciaio passante DIBOLT E16x110 con vite TE 8.8	12	110	16	25 pz	5 Scatole
NB61777	Tassello in acciaio passante DIBOLT E16x130 con vite TE 8.8	12	130	16	20 pz	5 Scatole
NB61779	Tassello in acciaio passante DIBOLT E16x150 con vite TE 8.8	12	150	16	20 pz	5 Scatole
NB61782	Tassello in acciaio passante DIBOLT E20x90 con vite TE 8.8	16	90	20	15 pz	5 Scatole
NB61784	Tassello in acciaio passante DIBOLT E20x110 con vite TE 8.8	16	110	20	15 pz	5 Scatole
NB61787	Tassello in acciaio passante DIBOLT E20x130 con vite TE 8.8	16	130	20	10 pz	5 Scatole
NB61789	Tassello in acciaio passante DIBOLT E20x150 con vite TE 8.8	16	150	20	10 pz	5 Scatole
NB61791	Tassello in acciaio passante DIBOLT E20x180 con vite TE 8.8	16	180	20	10 pz	5 Scatole

DIBOLT-SV - Tasselli in acciaio passanti con vite TSEI esagono incassato 10.9

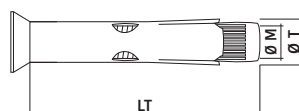

Codice	Descrizione	Ø M	LT mm	Ø T mm	Scatola singola	Imballo complessivo
NB61750	Tassello in acciaio passante DIBOLT-SV E8x50 con vite svasata	6	50	8	100 pz	5 Scatole
NB61755	Tassello in acciaio passante DIBOLT-SV E8x70 con vite svasata	6	70	8	100 pz	5 Scatole
NB61760	Tassello in acciaio passante DIBOLT-SV E10x55 con vite svasata	8	55	10	50 pz	5 Scatole
NB61765	Tassello in acciaio passante DIBOLT-SV E10x75 con vite svasata	8	75	10	50 pz	5 Scatole
NB61770	Tassello in acciaio passante DIBOLT-SV E10x100 con vite svasata	8	100	10	50 pz	5 Scatole
NB61775	Tassello in acciaio passante DIBOLT-SV E12x65 con vite svasata	10	65	12	50 pz	5 Scatole
NB61780	Tassello in acciaio passante DIBOLT-SV E12x80 con vite svasata	10	80	12	50 pz	5 Scatole
NB61785	Tassello in acciaio passante DIBOLT-SV E12x100 con vite svasata	10	100	12	50 pz	5 Scatole
NB61790	Tassello in acciaio passante DIBOLT-SV E12x120 con vite svasata	10	120	12	50 pz	5 Scatole

Tasselli in acciaio per calcestruzzo

Tasselli in acciaio autofilettante per fissaggi su materiali compatti per carichi di media portata. Indicata per carpenteria pesante, strutture provvisorie, scaffalature metalliche, tende da sole, ancoraggi di impianti di condizionamento, idraulici ed elettrici, strutture porta-cavi, scale antincendio e di sicurezza macchinari, strutture per facciate ventilate, segnaletica stradale, profili, ringhiere, corrimani, scale, ecc...

MATERIALI DI SUPPORTO CALCESTRUZZO, PIETRA NATURALE, MATTONE CLS PIENO

SCB - Tasselli in acciaio doppio filetto con testa esagonale flangiata

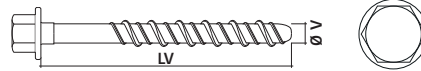

Codice	Descrizione	Chiave testa	Ø V mm	LV mm	Ø foro mm	Scatola singola	Imballo complessivo
NB59800	Tassello in acciaio SCB 6x40 testa esagonale flangiata	8	6	40	5	200 pz	5 Scatole
NB59802	Tassello in acciaio SCB 6x50 testa esagonale flangiata	8	6	50	5	200 pz	5 Scatole
NB59804	Tassello in acciaio SCB 6x75 testa esagonale flangiata	8	6	75	5	200 pz	5 Scatole
NB59806	Tassello in acciaio SCB 6x100 testa esagonale flangiata	8	6	100	5	200 pz	5 Scatole
NB59824	Tassello in acciaio SCB 7,5x50 testa esagonale flangiata	10	7,5	50	6	100 pz	10 Scatole
NB59828	Tassello in acciaio SCB 7,5x75 testa esagonale flangiata	10	7,5	75	6	100 pz	5 Scatole
NB59830	Tassello in acciaio SCB 7,5x100 testa esagonale flangiata	10	7,5	100	6	100 pz	5 Scatole
NB59832	Tassello in acciaio SCB 7,5x120 testa esagonale flangiata	10	7,5	120	6	100 pz	5 Scatole
NB59834	Tassello in acciaio SCB 7,5x150 testa esagonale flangiata	10	7,5	150	6	100 pz	5 Scatole

SCB - Tassello in acciaio doppio filetto con testa esagonale



Codice	Descrizione	Chiave testa	Ø V mm	LV mm	Ø foro mm	Scatola singola	Imballo complessivo
NB59850	Tassello in acciaio SCB 10x60 con testa esagonale	13	6	60	8	100 pz	5 Scatole
NB59852	Tassello in acciaio SCB 10x75 con testa esagonale	13	6	75	8	100 pz	5 Scatole
NB59854	Tassello in acciaio SCB 10x100 con testa esagonale	13	6	100	8	100 pz	5 Scatole
NB59858	Tassello in acciaio SCB 10x130 con testa esagonale	13	6	130	8	50 pz	5 Scatole
NB59860	Tassello in acciaio SCB 10x150 con testa esagonale	13	7,5	150	8	50 pz	5 Scatole
NB59880	Tassello in acciaio SCB 12x75 con testa esagonale	15	7,5	75	10	50 pz	5 Scatole
NB59882	Tassello in acciaio SCB 12x100 con testa esagonale	15	7,5	100	10	50 pz	5 Scatole
NB59884	Tassello in acciaio SCB 12x130 con testa esagonale	15	7,5	130	10	50 pz	5 Scatole

Tassello in acciaio per calcestruzzo

SCB CE - Tassello in acciaio con testa esagonale flangiata

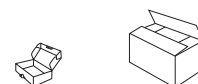
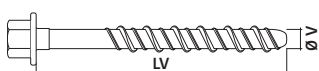

Codice	Descrizione	Chiave testa	Ø V mm	LV mm	Ø foro mm	Scatola singola	Imballo complessivo
NB59718	Tassello in acciaio SCB-CE 8x60/10 con testa esagonale	10	8	60	6	200 pz	5 Scatole
NB59720	Vite in acciaio SCB-CE 8x80/20 con testa esagonale flangiata	10	8	80	6	200 pz	5 Scatole
NB59722	Vite in acciaio SCB-CE 8x100/40 con testa esagonale flangiata	10	8	100	6	200 pz	5 Scatole
NB59724	Vite in acciaio SCB-CE 8x120/60 con testa esagonale flangiata	10	8	120	6	200 pz	5 Scatole
NB59726	Vite in acciaio SCB-CE 8x140/80 con testa esagonale flangiata	10	8	140	6	200 pz	5 Scatole
NB59740	Vite in acciaio SCB-CE 10x80/10 con testa esagonale flangiata	13	10	80	8	100 pz	5 Scatole
NB59742	Vite in acciaio SCB-CE 10x100/30 con testa esagonale flangiata	13	10	100	8	100 pz	5 Scatole
NB59744	Vite in acciaio SCB-CE 10x120/50 con testa esagonale flangiata	13	10	120	8	100 pz	5 Scatole
NB59746	Vite in acciaio SCB-CE 10x140/70 con testa esagonale flangiata	13	10	140	8	100 pz	5 Scatole
NB59748	Vite in acciaio SCB-CE 10x160/90 con testa esagonale flangiata	13	10	160	8	100 pz	5 Scatole
NB59760	Vite in acciaio SCB-CE 12x90/10 con testa esagonale flangiata	15	12	90	10	100 pz	5 Scatole
NB59762	Vite in acciaio SCB-CE 12x110/30 con testa esagonale flangiata	15	12	110	10	100 pz	5 Scatole
NB59764	Vite in acciaio SCB-CE 12x130/50 con testa esagonale flangiata	15	12	130	10	100 pz	5 Scatole
NB59766	Vite in acciaio SCB-CE 12x150/70 con testa esagonale flangiata	15	12	150	10	100 pz	5 Scatole
NB59770	Vite in acciaio SCB-CE 12x210/130 con testa esagonale flangiata	15	12	210	10	100 pz	5 Scatole
NB59772	Vite in acciaio SCB-CE 12x250/170 con testa esagonale flangiata	15	12	220	10	100 pz	5 Scatole
NB59774	Vite in acciaio SCB-CE 12x290/210 con testa esagonale flangiata	15	12	290	10	100 pz	5 Scatole
NB59790	Vite in acciaio SCB-CE 16x130/20 con testa esagonale flangiata	21	16	130	14	100 pz	5 Scatole
NB59792	Vite in acciaio SCB-CE 16x150/40 con testa esagonale flangiata	21	16	150	14	100 pz	5 Scatole
NB59794	Vite in acciaio SCB-CE 16x180/70 con testa esagonale flangiata	21	16	180	14	100 pz	5 Scatole

Viti in acciaio per calcestruzzo

AUT-C - Viti autofilettanti per calcestruzzo Torx T30

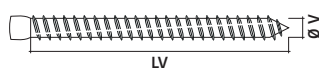

Indicate per opere di carpenteria metallica

Codice	Descrizione	Ø V mm	LV mm	Scatola singola	Imballo complessivo
NB97800	Vite autofilettante AUT-C 5x62 testa cilindrica T15	5	62	200 pz	10 Scatole
NB97810	Vite autofilettante AUT-C 5x82 testa cilindrica T15	5	82	200 pz	10 Scatole
NB97820	Vite autofilettante AUT-C 5x112 testa cilindrica T15	5	112	200 pz	10 Scatole
NB97880	Vite autofilettante AUT-C 7,5x52 testa cilindrica T30	7,5	52	100 pz	5 Scatole
NB97888	Vite autofilettante AUT-C 7,5x62 testa cilindrica T30	7,5	62	100 pz	5 Scatole
NB97891	Vite autofilettante AUT-C 7,5x72 testa cilindrica T30	7,5	72	100 pz	5 Scatole
NB97895	Vite autofilettante AUT-C 7,5x82 testa cilindrica T30	7,5	82	100 pz	5 Scatole
NB97899	Vite autofilettante AUT-C 7,5x92 testa cilindrica T30	7,5	92	100 pz	5 Scatole
NB53808	Vite autofilettante AUT-C 7,5x102 testa cilindrica T30	7,5	102	100 pz	5 Scatole
NB53811	Vite autofilettante AUT-C 7,5x112 testa cilindrica T30	7,5	112	100 pz	5 Scatole
NB53815	Vite autofilettante AUT-C 7,5x122 testa cilindrica T30	7,5	122	100 pz	5 Scatole
NB53820	Vite autofilettante AUT-C 7,5x132 testa cilindrica T30	7,5	132	100 pz	5 Scatole
NB53825	Vite autofilettante AUT-C 7,5x142 testa cilindrica T30	7,5	142	100 pz	5 Scatole
NB53830	Vite autofilettante AUT-C 7,5x152 testa cilindrica T30	7,5	152	100 pz	5 Scatole
NB53835	Vite autofilettante AUT-C 7,5x162 testa cilindrica T30	7,5	162	100 pz	5 Scatole
NB53840	Vite autofilettante AUT-C 7,5x172 testa cilindrica T30	7,5	172	100 pz	5 Scatole
NB53845	Vite autofilettante AUT-C 7,5x182 testa cilindrica T30	7,5	182	100 pz	5 Scatole
NB53850	Vite autofilettante AUT-C 7,5x202 testa cilindrica T30	7,5	202	100 pz	5 Scatole
NB53855	Vite autofilettante AUT-C 7,5x212 testa cilindrica T30	7,5	212	100 pz	5 Scatole

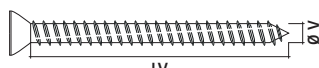

Codice	Descrizione	Ø V mm	LV mm	Scatola singola	Imballo complessivo
NB34570	Vite autofilettante AUT-C 7,5x52 Testa svasata T30	7,5	52	100 pz	5 Scatole
NB34579	Vite autofilettante AUT-C 7,5x62 Testa svasata T30	7,5	62	100 pz	5 Scatole
NB34582	Vite autofilettante AUT-C 7,5x72 Testa svasata T30	7,5	72	100 pz	5 Scatole
NB34586	Vite autofilettante AUT-C 7,5x82 Testa svasata T30	7,5	82	100 pz	5 Scatole
NB34590	Vite autofilettante AUT-C 7,5x92 Testa svasata T30	7,5	92	100 pz	5 Scatole
NB34593	Vite autofilettante AUT-C 7,5x102 Testa svasata T30	7,5	102	100 pz	5 Scatole
NB34600	Vite autofilettante AUT-C 7,5x112 Testa svasata T30	7,5	112	100 pz	5 Scatole
NB34609	Vite autofilettante AUT-C 7,5x122 Testa svasata T30	7,5	122	100 pz	5 Scatole
NB34615	Vite autofilettante AUT-C 7,5x132 Testa svasata T30	7,5	132	100 pz	5 Scatole
NB34620	Vite autofilettante AUT-C 7,5x142 Testa svasata T30	7,5	142	100 pz	5 Scatole
NB34625	Vite autofilettante AUT-C 7,5x152 Testa svasata T30	7,5	152	100 pz	5 Scatole
NB34629	Vite autofilettante AUT-C 7,5x162 Testa svasata T30	7,5	162	100 pz	5 Scatole
NB34635	Vite autofilettante AUT-C 7,5x172 Testa svasata T30	7,5	172	100 pz	5 Scatole
NB34640	Vite autofilettante AUT-C 7,5x182 Testa svasata T30	7,5	182	100 pz	5 Scatole
NB34645	Vite autofilettante AUT-C 7,5x202 Testa svasata T30	7,5	202	100 pz	5 Scatole



▲ Installazione di scale antincendio



▲ Installazione di facciate ventilate

Installazione di scaffalature industriali



FISSAGGI LEGGERI

FISSAGGI LEGGERI IN ACCIAIO E NYLON

EMC ²	39
NC	40-43
A-AB ELTEX	43
A	44
AB	45
AQ	47
TOP	48
TFN	49
TOP FUN	50
TOP FUNP	52
FP9	53
NNB	54
RG-S	55
TSP	56
FUA	60-62
AC	63
SP	64
SPZ	64
TC	64
V-ATL	65
V-FOSF	65
HAV	66
TUBE-FIX	67
GRAP-FIX	67
CLIP-FIX	67
CPV	68
PINZA	68
TNSM-RE	69
TNB	69
NGB	69
AK	70-71
BK	72-73
NC-PS	74-75
NC-L	76
NC-XL	76-77
AF	78-80
TNAP	78
TNSV	81
ABP	82
ABP-TR	82
ABP-TRF	83
AB PROL	83
AB TR	83
TNSM	84-86
TNA-FIL	87
TNB	87-89
TZB	89

Tasselli EMC² Bi-Materiale

Tassello universale bi-materiale con doppio bordo e avanzato sistema anti rotazione idoneo per fissaggio di carichi medio leggeri su materiali compatti, semicompatti, forati, pannello e lastre in cartongesso, tufo e calcestruzzo cellulare.

MATERIALI DI SUPPORTO CALCESTRUZZO, PIETRA NATURALE, MATTONI PIENI, MATTONE CLS PIENO, MATTONE FORATO, TUFO, LASTRE DI CARTONGESSO E CALCESTRUZZO CELLULARE.



Il tassello EMC² di Nobex è un ancorante universale bi-materiale, progettato per offrire elevate prestazioni su diversi tipi di materiali da costruzione.

CARATTERISTICHE PRINCIPALI:

- **Materiali:** La combinazione di due materiali attraverso un legame termochimico garantisce al tassello EMC² elevata resistenza meccanica e durata nel tempo.
- **Design:** Il tassello presenta un bordo con diametro maggiorato in doppia composizione e un'alettatura antirotazione composta da 8 elementi di tenuta prismatici, di cui 2 di bloccaggio in estrazione, assicurando una presa totale in tutto lo spessore del materiale.
- **Funzione antivibrante:** La struttura del tassello offre una funzione antivibrante, aumentando la sicurezza e la stabilità del fissaggio.

Vantaggi ambientali:

Il processo produttivo del tassello EMC² richiede un minore consumo energetico e una ridotta emissione di CO₂, rendendolo un prodotto ecologico sin dalla sua origine. Inoltre, è completamente riciclabile.



nobex.it



RISPARMIO ENERGETICO DI PRODUZIONE



ANTIVIBRANTE



SOFT TOUCH



MINORI EMISSIONI DI CO₂



MULTIMATERIALE



ANTISDRUCCIOLO



WATERPROOF



TEST SISMICI



RICICLABILE AL 100%



LEGAME TERMOCHIMICO



HIGH PERFORMANCE

Tasselli EMC² Bi-Materiale

EMC² - Tassello universale Bi-materiale Ø 6

SPAZIAMENTO
INGEGNERIA
CIVILE
ARCHITETTURA
dicar

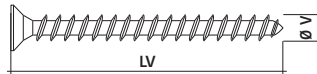
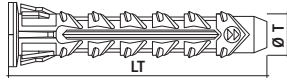

Codice	Descrizione	Ø T mm	LT mm	Ø V mm	LV mm	Scatola singola	Imballo complessivo
NB179106	Tassello Bi-materiale EMC ² 6X40 con vite TSP 3,5X50	6	40	3,5	50	50 pz	50 scatole
NB179116	Tassello Bi-materiale EMC ² 6X40 con vite TSP 3,5X50	6	40	3,5	50	100 pz	25 scatole
NB179126	Tassello Bi-materiale EMC ² 6X40 con vite TSP 3,5X50	6	40	3,5	50	200 pz	10 scatole



Disponibile in blister



Disponibile in secchiello

EMC² - Tassello universale Bi-materiale Ø 8

SPAZIAMENTO
INGEGNERIA
CIVILE
ARCHITETTURA
dicar

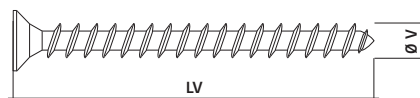
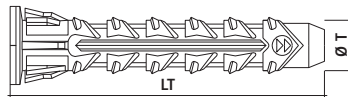

Codice	Descrizione	Ø T mm	LT mm	Ø V mm	LV mm	Scatola singola	Imballo complessivo
NB179108	Tassello Bi-materiale EMC ² 8X50 con vite TSP 4,5X60	8	50	4,5	60	20 pz	50 scatole
NB179118	Tassello Bi-materiale EMC ² 8X50 con vite TSP 4,5X60	8	50	4,5	60	50 pz	25 scatole
NB179128	Tassello Bi-materiale EMC ² 8X50 con vite TSP 4,5X60	8	50	4,5	60	80 pz	10 scatole



Disponibile in blister



Disponibile in secchiello

Fissaggi in nylon

Ancorante universale in nylon multiespansione idoneo per materiali compatti, semicompatti, forati, pannelli e lastre in cartongesso. Indicato per fissaggio di lampade, guide per tende e riloghe, piccoli pensili e armadietti, carpenteria leggera, interruttori e quadri elettrici, cassette portalettere, ecc...

MATERIALI DI SUPPORTO CALCESTRUZZO, PIETRA NATURALE, MATTONI PIENI, MATTONE CLS PIENO, MATTONI FORATI, MATTONE CLS FORATO E LASTRE DI CARTONGESSO.



NC - Tassello universale in nylon

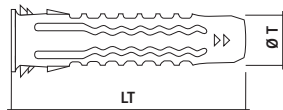

Confezioni standard

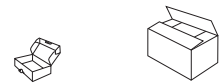

Codice	Descrizione	Ø T mm	LT mm	Scatola singola	Imballo complessivo
NB187768	Tassello universale NC 5 in nylon 5x25	5	25	200 pz	20 scatole
NB167928	Tassello universale NC 6 in nylon 6x30	6	30	100 pz	50 scatole
NB167935	Tassello universale NC 8 in nylon 8x40	8	40	100 pz	50 scatole
NB167942	Tassello universale NC 10 in nylon 10x50	10	50	50 pz	25 scatole
NB167950	Tassello universale NC 10 in nylon 10x60	10	60	50 pz	25 scatole
NB187674	Tassello universale NC 12 in nylon 12x60	12	60	25 pz	25 scatole
NB187704	Tassello universale NC 14 in nylon 14x70	14	70	20 pz	25 scatole

Disponibile in blister Disponibile in secchiello

Confezioni in buste



Codice	Descrizione	Ø T mm	LT mm	Busta singola	Imballo
NB173910	Plastic bag tassello universale NC 5 in nylon 5x25	5	25	1.000 pz	10 buste
NB173912	Plastic bag tassello universale NC 6 in nylon 6x30	6	30	1.000 pz	10 buste
NB173929	Plastic bag tassello universale NC 8 in nylon 8x40	8	40	500 pz	10 buste
NB173936	Plastic bag tassello universale NC 10 in nylon 10x50	10	50	250 pz	12 buste
NB173943	Plastic bag tassello universale NC 12 in nylon 12x60	12	60	150 pz	12 buste
NB173950	Plastic bag tassello universale NC 14 in nylon 14x70	14	70	100 pz	12 buste

Confezioni industriali

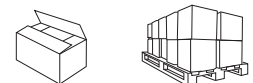

Codice	Descrizione	Ø T mm	LT mm	Scatola singola	Imballo pallet
NB187759	Bulk tassello universale NC 5 in nylon 5x25	5	25	55.000 pz	20 scatole
NB168093	Bulk tassello universale NC 6 in nylon 6x30	6	30	32.000 pz	20 scatole
NB168109	Bulk tassello universale NC 8 in nylon 8x40	8	40	15.000 pz	20 scatole
NB168116	Bulk tassello universale NC 10 in nylon 10x50	10	50	3.500 pz	20 scatole
NB168120	Bulk tassello universale NC 10 in nylon 10x60	10	60	3.000 pz	20 scatole
NB187667	Bulk tassello universale NC 12 in nylon 12x60	12	60	5.000 pz	14 scatole
NB187698	Bulk tassello universale NC 14 in nylon 14x70	10	60	1800 pz	20 scatole

Fissaggi in nylon

NCV - Tassello universale con vite truciolare DIN 7505/A

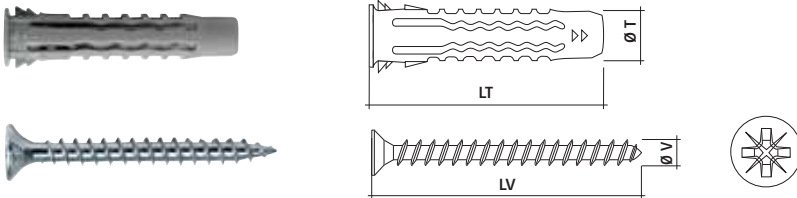

Confezioni standard

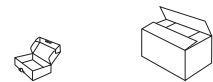

Codice	Descrizione	Ø T mm	LT mm	Ø V mm	LV mm	Scatola singola	Imballo complessivo
NB167941	Tassello universale NCV 5 in nylon 5x25 con vite TSP 4,0x30	5	25	4,0	30	200 pz	25 scatole
NB167966	Tassello universale NCV 6 in nylon 6x30 con vite TSP 4,5x40	6	30	4,5	40	100 pz	25 scatole
NB167973	Tassello universale NCV 8 in nylon 8x40 con vite TSP 5x50	8	40	5	50	100 pz	10 scatole
NB167980	Tassello universale NCV 10 in nylon 10x50 con vite TSP 6x60	10	50	6	60	50 pz	10 scatole
NB167985	Tassello universale NCV 10 in nylon 10x60 con vite TSP 6x80	10	60	6,0	80	50 pz	5 scatole



Disponibile in blister



Disponibile in secchiello

Confezioni in buste



Codice	Descrizione	Ø T mm	LT mm	Ø V mm	LV mm	Busta singola	Imballo complessivo
NB173000	Plastic bag tassello NCV 5 in nylon 6x30 con vite TSP 4,5x40	6	30	4,5	40	100 pz	5 buste
NB173006	Plastic bag tassello NCV 6 in nylon 6x30 con vite TSP 4,5x40	6	30	4,5	40	200 pz	5 buste
NB173008	Plastic bag tassello NCV 8 in nylon 8x40 con vite TSP 5x50	8	40	5	50	100 pz	5 buste

Confezioni in bustine



Codice	Descrizione	Ø T mm	LT mm	Ø V mm	LV mm	Busta singola	Imballo complessivi
NB172990	Small bag tassello NCV 5 in nylon 5x25 con vite TSP 4x30	5	25	4	30	10 pz	100 buste
NB172992	Small bag tassello NCV 6 in nylon 6x30 con vite TSP 4,5x40	6	30	4,5	40	10 pz	100 buste
NB172994	Small bag tassello NCV 8 in nylon 8x40 con vite TSP 5x45	8	40	5	45	10 pz	50 buste
NB172996	Small bag tassello NCV 10 in nylon 10x50 con vite TSP 6x60	10	50	6	60	10 pz	25 buste

Fissaggi in nylon

MATERIALI DI SUPPORTO CALCESTRUZZO, PIETRA NATURALE, MATTONI PIENI, MATTONE CLS PIENO, MATTONI FORATI, MATTONE CLS FORATO E LASTRE DI CARTONGESSO.

NCV-TL - Tasselli universali con vite truciolare testa larga

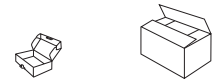
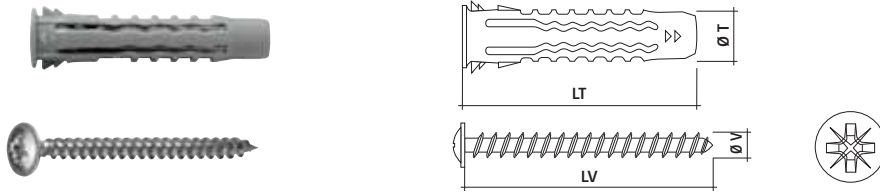

Codice	Descrizione	Ø T mm	LT mm	Ø V mm	LV mm	Scatola singola	Imballo complessivo
NB195501	Tassello universale NCV-TL 6 in nylon 6x30 con vite TL 4,5x40	6	30	4,5	40	100 pz	25 scatole
NB195525	Tassello universale NCV-TL 8 in nylon 8x40 con vite TL 5x45	8	40	5	45	100 pz	10 scatole

NCV-TC - Tasselli universali con vite truciolare testa cilindrica DIN 7505-B

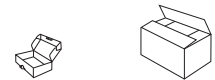
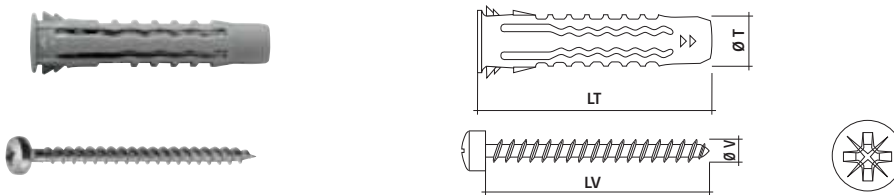

Codice	Descrizione	Ø T mm	LT mm	Ø V mm	LV mm	Scatola singola	Imballo complessivo
NB195518	Tassello universale NCV-TC 6 in nylon 6x30 con vite TC 5x40	6	30	5	40	100 pz	25 scatole
NB195532	Tassello universale NCV-TC 8 in nylon 8x40 con vite TC 6x60	8	40	6	60	100 pz	10 scatole

NCV-TE - Tasselli universali con tirafondo DIN 571 e rondella

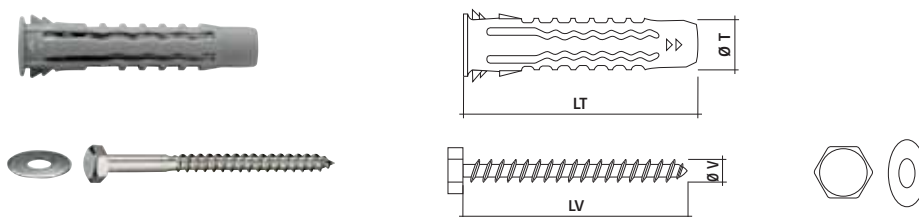

Codice	Descrizione	Ø T mm	LT mm	Ø V mm	LV mm	Scatola singola	Imballo complessivo
NB187844	Tassello universale NCV-TE 8 in nylon 8x40 con vite TE 5x50	8	40	5	50	100 pz	5 scatole
NB187851	Tassello universale NCV-TE 10 in nylon 10x50 con vite TE 6x60	10	50	6	60	100 pz	5 scatole
NB187858	Tassello universale NCV-TE 12 in nylon 12x60 con vite TE 8x70	12	60	8	70	50 pz	5 scatole
NB187865	Tassello universale NCV-TE 14 in nylon 14x70 con vite TE 10x80	14	70	10	80	25 pz	5 scatole

Fissaggi in nylon e eltex

NC-6 - Tasselli universali con pitoneria

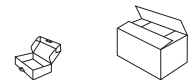
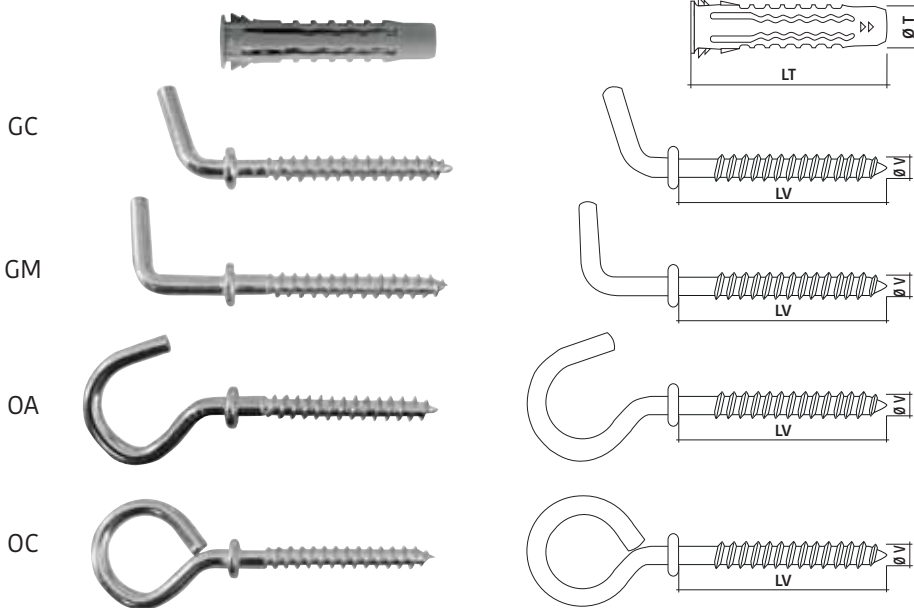

Codice	Descrizione	Ø T mm	LT mm	Ø V mm	LV mm	LP mm	Scatola singola	Imballo complessivo
NB187800	Tassello NC-GC in nylon 6x30 con pitoneria gancio corto 4,5x35	6	30	4,5	35	7	50 pz	5 scatole
NB187810	Tassello NC-GM in nylon 6x30 con pitoneria gancio medio 4,5x35	6	30	4,5	35	10	50 pz	5 scatole
NB187820	Tassello NC-OA in nylon 6x30 con pitoneria occhio aperto 4,5x35	6	30	4,5	35	12	50 pz	5 scatole
NB187830	Tassello NC-OC in nylon 6x30 con pitoneria occhio chiuso 4,5x35	6	30	4,5	35	12	50 pz	5 scatole

Disponibile in confezione blister

Disponibile in secchiello

A - AB ELTEX - Tassello universale in eltex con e senza bordo

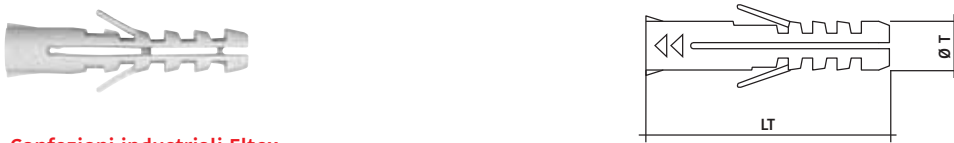

Confezioni industriali Eltex

Codice	Descrizione	Ø T mm	LT mm	Scatola singola	Imballo pallet
NB5043	Bulk tasselli A universali in eltex senza bordo 6x30	6	30	40.000 pz	19 scatole
NB5067	Bulk tasselli A universali in eltex senza bordo 8x40	8	40	17.000 pz	20 scatole
NB5074	Bulk tasselli A universali in eltex senza bordo 10x50	10	50	6.000 pz	20 scatole



Confezioni industriali Eltex

Codice	Descrizione	Ø T mm	LT mm	Scatola singola	Imballo pallet
NB75466	Bulk tasselli AB universali in eltex con bordo 6x30 ELTEX	6	30	32.000 pz	16 scatole
NB5166	Bulk tasselli AB universali in eltex con bordo 8x40 ELTEX	8	40	15.000 pz	16 scatole
NB5173	Bulk tasselli AB universali in eltex con bordo 10x50 ELTEX	10	50	5.000 pz	16 scatole

Fissaggi universali in nylon

Ancorante universale in nylon ad espansione con e senza bordo idoneo per materiali compatti, semicompatti, forati per carichi medio leggeri. Indicati per fissaggio di lampade, guide per tende e riloghe, piccoli pensili e armadietti, carpenteria leggera, interruttori e quadri elettrici, cassette portalettere, piccoli quadri e oggetti a parete, ecc...



MATERIALI DI SUPPORTO CALCESTRUZZO, PIETRA NATURALE, MATTONI PIENI, MATTONE CLS PIENO, LEGNO

A - Tassello universale in nylon senza bordo

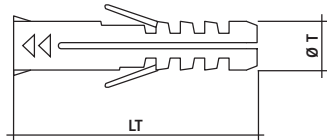
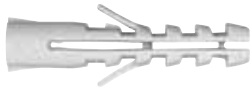

Confezioni standard

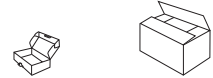

Codice	Descrizione	Ø T mm	LT mm	Scatola singola	Imballo complessivo
NB4633	Tasselli universali A in nylon senza bordo 4x20	4	20	200 pz	20 scatole
NB4640	Tasselli universali A in nylon senza bordo 5x25	5	25	200 pz	20 scatole
NB75152	Tasselli universali A in nylon senza bordo 6x30	6	30	100 pz	100 scatole
NB75138	Tasselli universali A in nylon senza bordo 7x30	7	30	100 pz	100 scatole
NB75145	Tasselli universali A in nylon senza bordo 8x40	8	40	100 pz	50 scatole
NB75169	Tasselli universali A in nylon senza bordo 10x50	10	50	50 pz	25 scatole
NB4695	Tasselli universali A in nylon senza bordo 12x60	12	60	25 pz	25 scatole
NB4701	Tasselli universali A in nylon senza bordo 14x75	14	75	20 pz	25 scatole
NB8044	Tasselli universali A in nylon senza bordo 16x80	16	80	20 pz	10 scatole

Confezioni in bustine



Codice	Descrizione	Ø T mm	LT mm	Busta singola	Imballi complessivo
NB74155	Small bag tasselli universali in nylon senza bordo A 6x30	6	30	10 pz	50 buste

Confezioni industriali in buste



Codice	Descrizione	Ø T mm	LT mm	Busta singola	Imballo complessivo
NB65948	Plastic bag tasselli universali A in nylon senza bordo 4x20	4	20	1.000 pz	10 buste
NB75176	Plastic bag tasselli universali A in nylon senza bordo 5x25	5	25	1.000 pz	12 buste
NB75183	Plastic bag tasselli universali A in nylon senza bordo 6x30	6	30	1.000 pz	12 buste
NB75190	Plastic bag tasselli universali A in nylon senza bordo 8x40	8	40	500 pz	12 buste
NB75282	Plastic bag tasselli universali A in nylon senza bordo 10x50	10	50	250 pz	12 buste

Confezioni industriali



Codice	Descrizione	Ø T mm	LT mm	Scatola singola	Imballo pallet
NB74902	Bulk tasselli universali A in nylon senza bordo 4x20	4	20	90.000 pz	15 scatole
NB75077	Bulk tasselli universali A in nylon senza bordo 5x25	5	25	60.000 pz	15 scatole
NB75008	Bulk tasselli universali A in nylon senza bordo 6x30	6	30	38.000 pz	20 scatole
NB75015	Bulk tasselli universali A in nylon senza bordo 7x30	7	30	30.000 pz	20 scatole
NB75022	Bulk tasselli universali A in nylon senza bordo 8x40	8	40	17.000 pz	20 scatole
NB75039	Bulk tasselli universali A in nylon senza bordo 10x50	10	50	11.500 pz	20 scatole
NB4800	Bulk tasselli universali A in nylon senza bordo 12x60	12	60	3.500 pz	20 scatole
NB4817	Bulk tasselli universali A in nylon senza bordo 14x75	14	75	2.000 pz	20 scatole
NB4824	Bulk tasselli universali A in nylon senza bordo 16x80	16	80	1.800 pz	20 scatole

Fissaggi universali in nylon

AB - Tassello universale in nylon con bordo

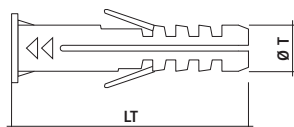

Confezioni standard



Codice	Descrizione	Ø T mm	LT mm	Scatola singola	Imballo complessivo
NB62039	Tassello universale AB in nylon con bordo 4x20	4	20	200 pz	20 scatole
NB75206	Tassello universale AB in nylon con bordo 5x25	5	25	200 pz	20 scatole
NB75213	Tassello universale AB in nylon con bordo 6x30	6	30	100 pz	100 scatole
NB51910	Tassello universale AB in nylon con bordo 7x30	7	30	100 pz	100 scatole
NB75220	Tassello universale AB in nylon con bordo 8x40	8	40	100 pz	50 scatole
NB75237	Tassello universale AB in nylon con bordo 10x50	10	50	50 pz	25 scatole
NB75404	Tassello universale AB in nylon con bordo 10x60	10	60	40 pz	25 scatole
NB50784	Tassello universale AB in nylon con bordo 12x60	12	60	25 pz	25 scatole
NB51842	Tassello universale AB in nylon con bordo 14x75	14	75	20 pz	25 scatole

Confezioni in bustine

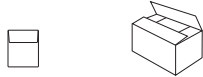

Codice	Descrizione	Ø T mm	LT mm	Busta singola	Imballo complessivo
NB74162	Small bag tassello universale AB in nylon con bordo 6x30	6	30	10 pz	50 buste

Confezioni industriali in buste



Codice	Descrizione	Ø T mm	LT mm	Busta singola pz	Imballo complessivo
NB62046	Plastic bag tassello AB universale in nylon con bordo 4x20	4	20	1.000 pz	10 buste
NB49610	Plastic bag tassello AB universale in nylon con bordo 5x25	5	25	1.000 pz	10 buste
NB75343	Plastic bag tassello AB universale in nylon con bordo 6x30	6	30	1.000 pz	10 buste
NB49597	Plastic bag tassello AB universale in nylon con bordo 8x40	8	40	500 pz	10 buste
NB49603	Plastic bag tassello AB universale in nylon con bordo 10x50	10	50	250 pz	12 buste

Confezioni industriali



Codice	Descrizione	Ø L mm	L mm	Scatola singola	Imballo pallet
NB74995	Bulk tasselli AB universali in nylon con bordo 4X20	4	20	90.000 pz	15 scatole
NB75046	Bulk tasselli AB universali in nylon con bordo 5x25	5	25	60.000 pz	15 scatole
NB75053	Bulk tasselli AB universali in nylon con bordo 6x30	6	30	32.000 pz	20 scatole
NB50548	Bulk tasselli AB universali in nylon con bordo 7x30	7	30	24.000 pz	20 scatole
NB75060	Bulk tasselli AB universali in nylon con bordo 8x40	8	40	15.000 pz	20 scatole
NB74889	Bulk tasselli AB universali in nylon con bordo 10x50	10	50	10.000 pz	16 scatole
NB5203	Bulk tasselli AB universali in nylon con bordo 10x60	10	60	6.000 pz	20 scatole
NB49405	Bulk tasselli AB universali in nylon con bordo 12x60	12	60	3.200 pz	20 scatole
NB51835	Bulk tasselli AB universali in nylon con bordo 14x75	14	75	1.800 pz	20 scatole

Fissaggi universali in nylon

MATERIALI DI SUPPORTO CALCESTRUZZO, PIETRA NATURALE, MATTONI PIENI, MATTONE CLS PIENO, CLS CELLULARE, LEGNO

AV-TC - Tassello in nylon senza bordo con vite truciolare DIN 7505/A

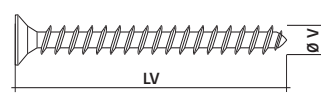
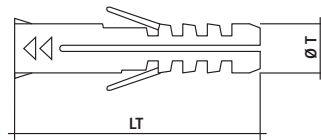

Codice	Descrizione	Ø T mm	LT mm	Ø V mm	LV mm	Scatola singola	Imballo complessivo
NB75244	Tasselli universali AV in nylon senza bordo 5x25 con vite TSP 4x30	5	25	4,0	30	200 pz	25 scatole
NB75251	Tasselli universali AV in nylon senza bordo 6x30 con vite TSP 4,5x40	6	30	4,5	40	100 pz	25 scatole
NB75268	Tasselli universali AV in nylon senza bordo 8x40 con vite TSP 5,0x45	8	40	5,0	45	100 pz	10 scatole
NB75275	Tasselli universali AV in nylon senza bordo 10x50 con vite TSP 6,0x60	10	60	6,0	60	50 pz	10 scatole



Disponibile in blister



Disponibile in secchiello

AVB-TC - Tassello in nylon con bordo con vite truciolare DIN 7505/A

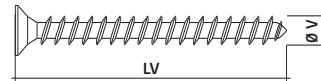
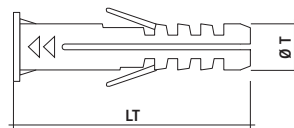
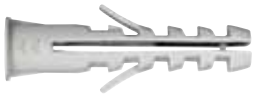

Codice	Descrizione	Ø T mm	LT mm	Ø V mm	LV mm	Scatola singola	Imballo complessivo
NB75411	Tasselli universali AVB in nylon con bordo 5 con vite TSP 4x30	5	25	4,0	30	200 pz	25 scatole
NB75428	Tasselli universali AVB in nylon con bordo 6 con vite TSP 4,5x40	6	30	4,5	40	100 pz	25 scatole
NB75435	Tasselli universali AVB in nylon con bordo 8 con vite TSP 5x45	8	40	5,0	45	100 pz	10 scatole
NB75442	Tasselli universali AVB in nylon con bordo 10 con vite TSP 6x60	10	60	6,0	60	50 pz	10 scatole



Disponibile in blister



Disponibile in secchiello

Fissaggi universali in nylon

AV-TE - Tassello AV con tirafondo DIN 571 e rondella

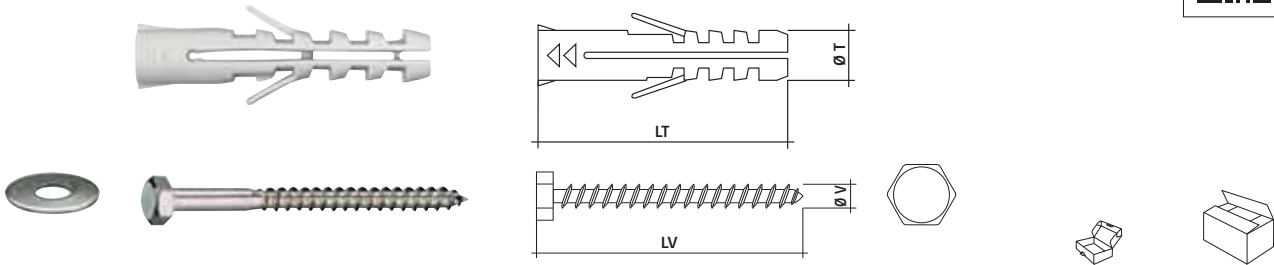

Codice	Descrizione	Ø T mm	LT mm	Ø V mm	LV mm	Scatola singola	Imballo complessivo
NB8075	Tassello AV-TE in nylon senza bordo 8x40 con vite TE 6x45	8	40	6	45	100 pz	10 scatole
NB8082	Tassello AV-TE in nylon senza bordo 10x50 con vite TE 7x60	10	50	7	60	100 pz	5 scatole
NB8099	Tassello AV-TE in nylon senza bordo 12x60 con vite TE 8x70	12	60	8	70	50 pz	5 scatole
NB8105	Tassello AV-TE in nylon senza bordo 14x75 con vite TE 10x80	14	75	10	80	25 pz	5 scatole
NB8112	Tassello AV-TE in nylon senza bordo 16x80 con vite TE 12x90	16	80	12	90	25 pz	5 scatole

KIT AVB-TC - Tassello AVB con vite truciolare DIN 7505/A

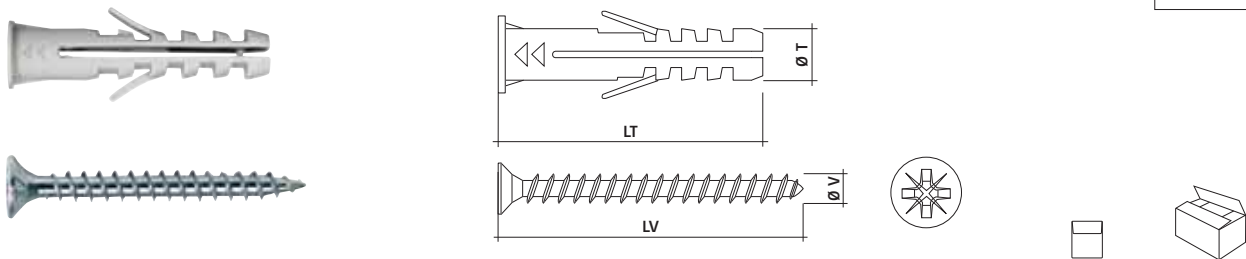

Codice	Descrizione	Ø T mm	LT mm	Ø V mm	LV mm	Busta singola	Imballo complessivo
NB74105	Small bag tassello AVB in nylon con bordo 5x25 con vite TSP 4x30	5	25	4,0	30	10 pz	100 buste
NB74106	Small bag tassello AVB in nylon con bordo 6x30 con vite TSP 4,5x40	6	30	4,5	40	10 pz	100 buste
NB74108	Small bag tassello AVB in nylon con bordo 8x40 con vite TSP 5x45	8	40	5,0	45	10 pz	50 buste
NB74110	Small bag tassello AVB in nylon con bordo 10x50 con vite TSP 6x60	10	50	6,0	60	10 pz	25 buste

AQ - Tassello AV con vite truciolare DIN 7505/A in formato espositore

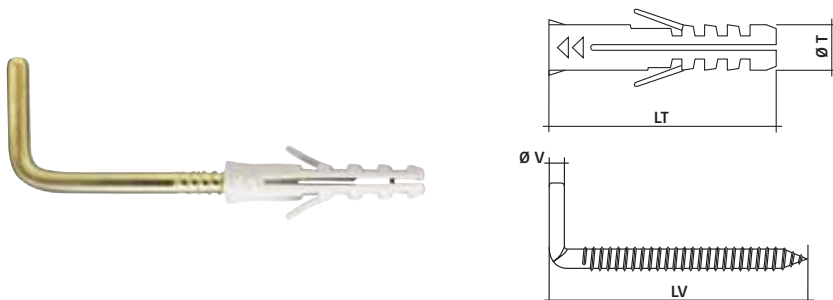

Espositore da 30 scatoline ognuna contenente 10 tasselli Ø 4 e 10 ganci.
Prodotto non vendibile separatamente.

Codice	Descrizione	Ø T mm	LT mm	Ø V mm	LV mm	Scatola singola	Contenuto espositore
NB5371	Espositore tassello AQ in nylon senza bordo in nylon con cancano	4	20	2,5	38	10 pz	30 scatole

Disponibile in blister

Fissaggi universali leggeri

Ancorante universale in polipropilene con bordo, multiespansione, idoneo per materiali compatti, semi compatti e forati, per carichi medio leggeri. Indicato per fissaggio di lampade, guide per tende e riloghe, piccoli pensili e armadietti, carpenteria leggera, interruttori e quadri elettrici, cassette portalettere, piccoli quadri e oggetti a parete, ecc...

MATERIALI DI SUPPORTO CALCESTRUZZO, PIETRA NATURALE, MATTONI PIENI, MATTONE CLS PIENO

TOP-CB - Tassello universale in polipropilene

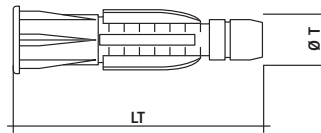

Confezioni standard

Codice	Descrizione	Ø T mm	LT mm	Scatola singola	Imballo complessivo
NB7924	Tassello universale TOP-CB in polipropilene 6x38	6	38	200 pz	25 scatole
NB7931	Tassello universale TOP-CB in polipropilene 8x51	8	51	100 pz	10 scatole
NB7948	Tassello universale TOP-CB in polipropilene 10x60	10	60	50 pz	10 scatole

Disponibile in blister

Confezioni in busta

Codice	Descrizione	Ø T mm	LT mm	Scatola singola	Imballo complessivo
NB49375	Plastic bag tassello universale TOP-CB in polipropilene 6x38	6	38	1.000 pz	10 scatole
NB49382	Plastic bag tassello universale TOP-CB in polipropilene 8x51	8	51	500 pz	10 scatole
NB49399	Plastic bag tassello universale TOP-CB in polipropilene 10x60	10	60	250 pz	12 scatole

Confezioni industriali

Codice	Descrizione	Ø T mm	LT mm	Scatola singola	Imballo pallet
NB48149	Bulk tassello universale TOP-CB in polipropilene 6x38	6	38	35.000 pz	16 scatole
NB48156	Bulk tassello universale TOP-CB in polipropilene 8x51	8	51	15.000 pz	16 scatole
NB47791	Bulk tassello universale TOP-CB in polipropilene 10x 60	10	60	6.000 pz	16 scatole

TOP-V CB - Tassello universale in polipropilene con vite truciolare DIN 7505/A

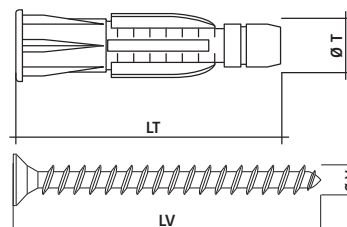

Codice	Descrizione	Ø T mm	LT mm	Ø V mm	LV mm	Scatola singola	Imballo complessivo
NB20558	Tassello universale TOP-V CB in polipropilene 6x38 con vite TSP 4x50	6	38	4	50	100	11 scatole
NB20565	Tassello universale TOP-V CB in polipropilene 8x51 con vite TSP 5x60	8	51	5	60	50	10 scatole
NB20572	Tassello universale TOP-V CB in polipropilene 10x60 con vite TSP 6x70	10	60	6	70	40	10 scatole

Disponibile in blister

Fissaggi universali leggeri

Ancorante universale in nylon ad espansione, con bordo idoneo per materiali compatti, semi compatti, forati, pannelli e lastre per carichi medio leggeri. Indicato per fissaggio di lampade, guide per tende e riloghe, piccoli pensili e armadietti, carpenteria leggera, interruttori e quadri elettrici, cassette portalettere, piccoli quadri e oggetti a parete, ecc...



MATERIALI DI SUPPORTO CALCESTRUZZO, PIETRA NATURALE, MATTONI PIENI, MATTONE CLS PIENO

TFN - Tassello universale in nylon ideale per forati e lastre

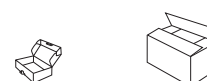
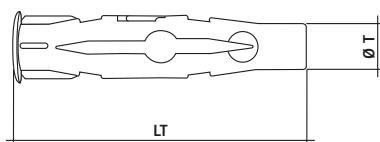

Confezioni standard

Codice	Descrizione	Ø T mm	LT mm	Scatola singola	Imballo complessivo
NB45780	Tassello universale TFN in nylon 6x40	6	40	200 pz	10 scatole
NB45797	Tassello universale TFN in nylon 8x50	8	50	100 pz	10 scatole
NB45803	Tassello universale TFN in nylon 10x60	10	60	50 pz	10 scatole

Confezioni in busta

Codice	Descrizione	Ø T mm	LT mm	Busta singola	Imballo complessivo
NB73967	Plastic bag tassello universale TFN in nylon 6x40	6	40	1.000	10 scatole
NB73974	Plastic bag tassello universale TFN in nylon 8x50	8	50	500	10 scatole
NB73981	Plastic bag tassello universale TFN in nylon 10x60	10	60	250	12 scatole

Confezioni industriali

Codice	Descrizione	Ø T mm	LT mm	Scatola singola	Imballo pallet
NB46176	Bulk tassello universale TFN in nylon 6x40	6	40	20.000 pz	16 scatole
NB46183	Bulk tassello universale TFN in nylon 8x50	8	50	10.000 pz	16 scatole
NB46190	Bulk tassello universale TFN in nylon 10x60	10	60	6.000 pz	16 scatole

TFN-V - Tassello universale in nylon per forati e lastre con vite truciolare DIN 7505/A

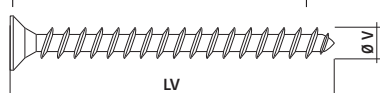
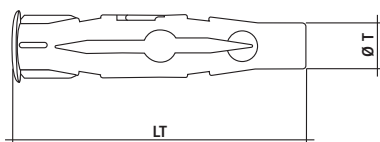

Codice	Descrizione	Ø T mm	LT mm	Ø V mm	LV mm	Scatola singola	Imballo complessivo
NB45810	Tassello universale in nylon TFN-V 6 con vite TSP 3,5x45	6	40	3,5	45	100 pz	10 scatole
NB45827	Tassello universale in nylon TFN-V 8 con vite TSP 4,5x60	8	50	4,5	60	50 pz	10 scatole
NB45834	Tassello universale in nylon TFN-V 10 con vite TSP 6x80	10	60	10	80	40 pz	5 scatole

Disponibile in blister

Fissaggi universali in nylon

Completati di pitoneria

Ancoranti in nylon ad espansione con vite metrica, ideati per fissaggi su materiali compatti, semi compatti e forati, per installazioni distanziate per carichi medio leggeri. Fissaggio di lampade, pensili, quadri, impianti di antifurto, assi di legno, interruttori, accessori bagno, armadietti a muro, tende e riloghe, ecc.,



MATERIALI DI SUPPORTO CALCESTRUZZO, PIETRA NATURALE, MATTONI PIENI, MATTONE CLS PIENO

TOP FUN-V - Tassello universale in nylon con vite metrica

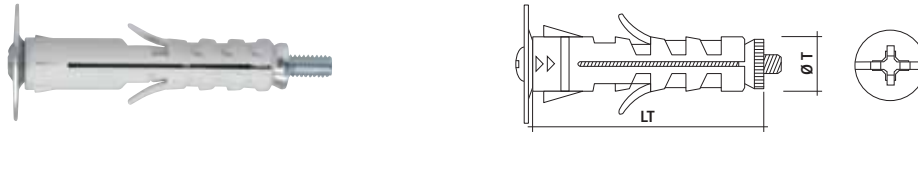

Codice	Descrizione	Ø T mm	LT mm	Ø V mm	LV mm	Scatola singola	Imballo complessivo
NB17641	Tassello in nylon TOP FUN-V 4 9x40 con vite metrica 4x45	9	40	4	52	100 pz	5 scatole
NB17658	Tassello in nylon TOP FUN-V 5 12x45 con vite metrica 4x50	12	45	5	55	100 pz	5 scatole

Disponibile in blister Disponibile in secchiello

TOP FUN-CG - Tassello universale in nylon con pitoneria - gancio corto

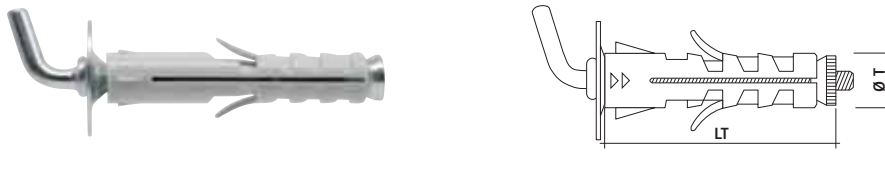

Codice	Descrizione	LG mm	Ø T mm	LT mm	Ø V mm	LV mm	Scatola singola	Imballo complessivo
NB17665	Tassello TOP FUN-GC 4 in nylon 9x40 con gancio corto 4x45	7	9	40	4	45	100 pz	5 scatole
NB17672	Tassello TOP FUN-GC 5 in nylon 12x45 con gancio corto 5x50	7	12	45	5	50	100 pz	5 scatole

Disponibile in blister Disponibile in secchiello

TOP FUN-GM - Tassello universale in nylon con pitoneria - gancio medio

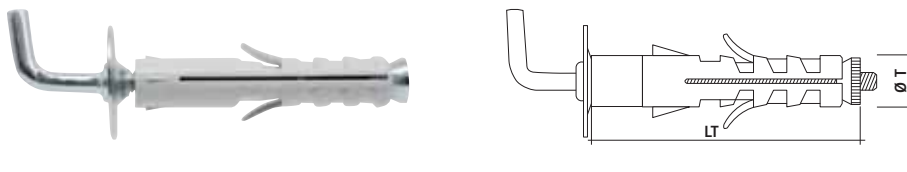

Codice	Descrizione	LG mm	Ø T mm	LT mm	Ø V mm	LV mm	Scatola singola	Imballo complessivo
NB129773	Tassello TOP FUN-GM 4 in nylon 9x40 con gancio medio 4x45	10	9	40	4	-	100 pz	5 scatole
NB17689	Tassello TOP FUN-GM 5 in nylon 12x45 con gancio medio 5x50	10	12	45	5	-	100 pz	5 scatole

Disponibile in blister Disponibile in secchiello

TOP FUN-GL - Tassello universale in nylon con pitoneria - gancio lungo

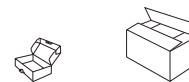
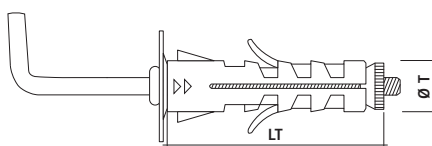
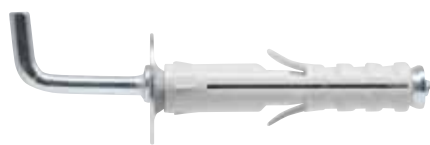

Codice	Descrizione	LG mm	Ø T mm	LT mm	Ø V mm	LV mm	Scatola singola	Imballo complessivo
NB17696	Tassello TOP FUN-GL 4 in nylon 9x40 con gancio lungo 4x45	20	9	40	4	-	100 pz	5 scatole
NB17702	Tassello TOP FUN-GL 5 in nylon 12x45 con gancio lungo 5x50	20	12	45	5	-	100 pz	5 scatole

Disponibile in blister Disponibile in secchiello

TOP FUN-OA - Tassello universale in nylon con pitoneria - occhiolo aperto

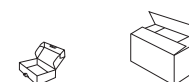
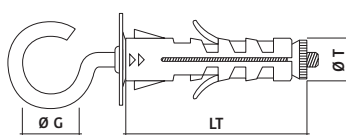

Codice	Descrizione	Ø T mm	LT mm	Ø V mm	LV mm	Ø G mm	Scatola singola	Imballo complessivo
NB17719	Tassello TOP FUN-OA 4 in nylon 9x40 con gancio occhiolo aperto	9	40	4	45	12	100 pz	5 scatole
NB17726	Tassello TOP FUN-OA 5 in nylon 12x45 con gancio occhiolo aperto	12	45	5	50	12	100 pz	5 scatole

Disponibile in blister Disponibile in secchiello

TOP FUN-OC - Tassello universale in nylon con pitoneria - occhiolo chiuso

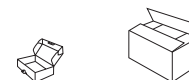
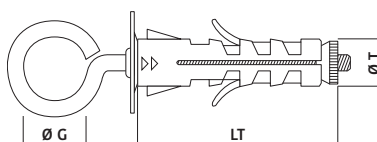

Codice	Descrizione	Ø T mm	LT mm	Ø V mm	LV mm	Ø G mm	Busta singola	Imballo complessivo
NB17733	Tassello TOP FUN-OC 4 in nylon 9x40 con gancio occhiolo chiuso	9	40	4	45	12	100 pz	5 scatole
NB17740	Tassello TOP FUN-OC 5 in nylon 12x45 con gancio occhiolo chiuso	12	45	5	50	12	100 pz	5 scatole

Disponibile in blister Disponibile in secchiello

TOP FUN-DD - Tassello universale in nylon con vite metrica e doppio dado

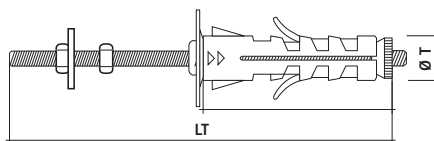

Codice	Descrizione	Ø T mm	LT mm	Ø V mm	LV mm	Confezione singola	Imballo complessivo
NB17757	Tassello TOP FUN-DD 4 in nylon 9x40 con vite metrica e doppio dado	9	40	4	73	100 pz	5 scatole
NB17764	Tassello TOP FUN-DD 5 in nylon 12x45 con vite metrica e doppio dado	12	45	5	76	100 pz	5 scatole

Disponibile in blister Disponibile in secchiello

Fissaggi universali prolungati in nylon

Completì di pitoneria

Ancoranti in nylon ad espansione con vite metrica, ideati per fissaggi su materiali compatti semi compatti e forati per installazioni distanziate per carichi medio leggeri. Fissaggio di lampade, pensili, quadri, impianti di antifurto, assi di legno, interruttori, accessori bagno, armadietti a muro, tende e riloghe, ecc.,

MATERIALI DI SUPPORTO CALCESTRUZZO, PIETRA NATURALE, MATTONI PIENI, MATTONI CLS PIENO, MATTONI FORATI

TOP FUNP-V - Tassello universale prolungato in nylon con vite metrica

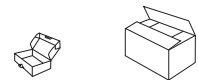
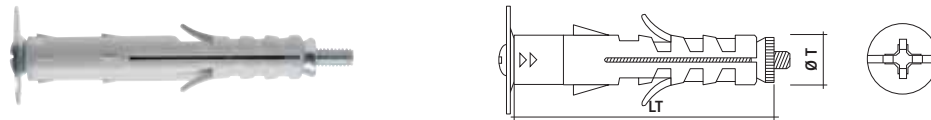

Codice	Descrizione	Ø T mm	LT mm	Ø V mm	LV mm	Scatola singola	Imballo complessivo
NB17771	Tassello prolungato TOP FUNP-V 4 in nylon 9x50 con vite metrica 4x65	9	50	4	65	100 pz	5 scatole
NB17788	Tassello prolungato TOP FUNP-V 5 in nylon 12x55 con vite metrica 5x65	12	55	5	65	100 pz	5 scatole

TOP FUNP-GC - Tassello prolungato in nylon con pitoneria - gancio corto

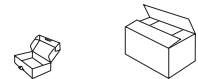
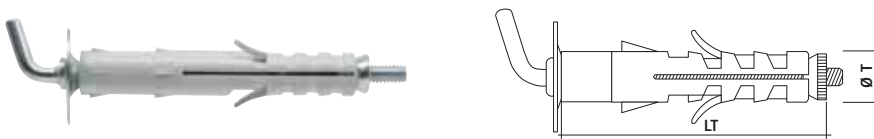

Codice	Descrizione	Ø T mm	LT mm	Ø V mm	LV mm	Scatola singola	Imballo complessivo
NB17795	Tassello prolungato TOP FUNP-GC 4 in nylon 9x50 con gancio corto 4x60	9	50	4	60	100 pz	5 scatole
NB17801	Tassello prolungato TOP FUNP-GC 5 in nylon 12x55 con gancio corto 5x60	12	55	5	60	100 pz	5 scatole

TOP FUNP-GM - Tassello prolungato in nylon con pitoneria - gancio medio

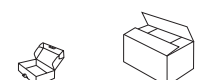
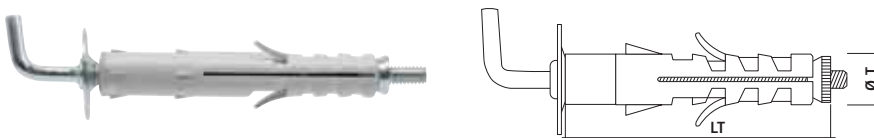

Codice	Descrizione	Ø T mm	LT mm	Ø V mm	LV mm	Scatola singola	Imballo complessivo
NB17818	Tassello prolungato TOP FUNP-GM 4 in nylon 9x50 con gancio medio 4x60	9	50	4	60	100 pz	5 scatole
NB17825	Tassello prolungato TOP FUNP-GM 5 in nylon 12x55 con gancio medio 5x60	12	55	5	60	100 pz	5 scatole

Fissaggi universali prolungati in nylon

TOP FUNP-OA - Tassello prolungato in nylon con pitoneria - occhio aperto

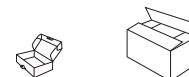
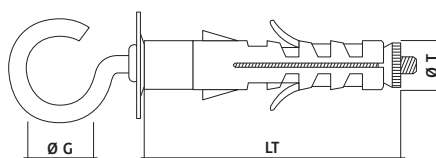

Codice	Descrizione	Ø T mm	LT mm	Ø V mm	LV mm	Ø G mm	Scatola singola	Imballo complessivo
NB151064	Tassello prolungato TOP FUNP-OA in nylon 12x55 occhio aperto	12	55	5	60	14	50 pz	5 scatole

TOP FUNP-OC - Tassello prolungato in nylon con pitoneria - occhio chiuso

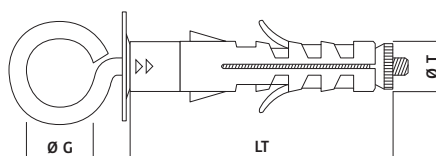

Codice	Descrizione	Ø T mm	LT mm	Ø V mm	LV mm	Ø G mm	Scatola singola	Imballo complessivo
NB151071	Tassello prolungato TOP FUNP-OC in nylon 12x55 occhio chiuso	12	55	5	60	14	100 pz	5 scatole

Paracolpi per porte

Paracolpo in PVC, in vari colori abbinato a tasselli tipo FUN

MATERIALI DI SUPPORTO CALCESTRUZZO, PIETRA NATURALE, MATTONI PIENI, MATTONE CLS PIENO

FP 9 - Paracolpi in PVC con tassello FUN-V Ø 9 universale in nylon e vite metrica

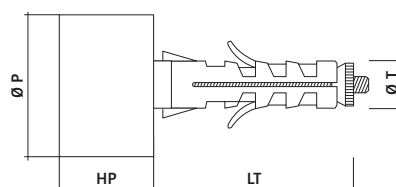

Codice	Descrizione	Ø T mm	LT mm	Ø P mm	HP mm	Ø V mm	LV mm	Scatola singola	Imballo complessivo
NB19590	Paracolpi in PVC FP 9 colore bianco	9	40	28	18	4	60	20 pz	10 scatole
NB19606	Paracolpi in PVC FP 9 colore nero	9	40	28	18	4	60	20 pz	10 scatole
NB19613	Paracolpi in PVC FP 9 colore beige	9	40	28	18	4	60	20 pz	10 scatole
NB19620	Paracolpi in PVC FP 9 colore grigio	9	40	28	18	4	60	20 pz	10 scatole
NB19637	Paracolpi in PVC FP 9 colore marrone	9	40	28	18	4	60	20 pz	10 scatole

Disponibile in blister

Fissaggi in nylon

Ancorante in nylon ad espansione di tipo passante idoneo per fissaggi su materiali compatti semi compatti e forati per carichi medio leggeri, indicato per fissaggio di scaldabagno, caldaie, pensili, impianti, accessori bagno, armadietti a muro, mensole a scomparsa, serramenti, cancellate, ringhiere, inferriate, arredo da giardino, segnaletica stradale, gazebo, ecc...



MATERIALI DI SUPPORTO CALCESTRUZZO, PIETRA NATURALE, MATTONI PIENI E SEMIPIENI, MATTONE CLS PIENO

NNB - Tassello passante in nylon con nottolino zincato

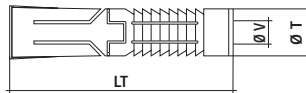

Codice	Descrizione	Ø T mm	LT mm	Ø Interno mm	Busta singola pz	Imballo complessivo
NB8556	Tassello passante in nylon NNB 8x70	12	70	8	50 pz	5 scatole
NB8563	Tassello passante in nylon NNB 10x75	14	75	10	50 pz	5 scatole

Disponibile in blister

NNBB - Tassello passante in nylon con vite a testa esagonale

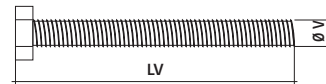
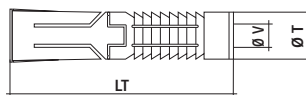

Codice	Descrizione	Ø T mm	LT mm	Ø V mm	LV mm	Scatola singola	Imballo complessivo
NB8570	Tassello passante NNBB 12 in nylon 12x70 con vite TE 8x80	12	70	8	80	40 pz	5 scatole
NB8587	Tassello passante NNBB 14 in nylon 14x75 con vite TE 10x80	14	75	10	80	40 pz	5 scatole

NNB-CG - Tassello passante in nylon con codetta

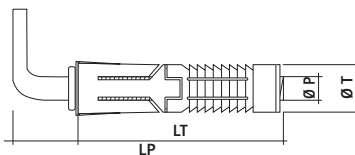

kit 2 pz

Codice	Descrizione	Ø T mm	LT mm	Ø P mm	LP mm	Scatola singola	Imballo complessivo
NB10337	Tassello passante NNB-CG M 14x80 con codetta	14	80	10	95	2	25 scatole

Disponibile in blister

Disponibile in blistere da 2

Reggimensola a scomparsa

Reggimensola a scomparsa con tassello per pareti compatte e semi compatte e forate.

MATERIALI DI SUPPORTO CALCESTRUZZO, PIETRA NATURALE, MATTONI PIENI, MATTONE CLS PIENO, MATTONI FORATI, MATTONE CLS FORATO

RG-S - Reggimensola a scomparsa con tassello in nylon



Ø 8/10

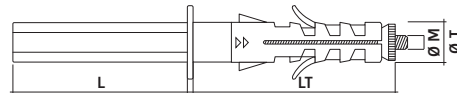

Ø 12/14

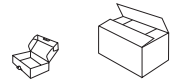
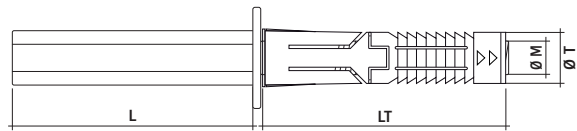

Codice	Descrizione	CH chiave	Ø B foro mensola mm	L reggi mensola mm	Ø T tassello mm	LT tassello mm	Ø M filetto mm	Scatola singola	Imballo complessivo
NB73905	Reggimensola a scomparsa con tassello RG-S 8x70	7	8	70	9	50	4	30 pz	5 scatole
NB9850	Reggimensola a scomparsa con tassello RG-S 10x 70	8	10	70	12	55	8	30 pz	5 scatole
NB9867	Reggimensola a scomparsa con tassello RG-S 10x100	8	10	95	12	55	8	30 pz	5 scatole
NB9935	Reggimensola a scomparsa con tassello RG-S 10x150	8	10	150	12	55	8	30 pz	5 scatole
NB72885	Reggimensola a scomparsa con tassello RG-S 12x80	10	12	80	12	70	8	30 pz	5 scatole
NB9874	Reggimensola a scomparsa con tassello RG-S 12x100	10	12	95	14	70	10	30 pz	5 scatole
NB9881	Reggimensola a scomparsa con tassello RG-S 12x145	10	12	145	14	70	10	30 pz	5 scatole
NB9898	Reggimensola a scomparsa con tassello RG-S 14x120	12	14	115	14	75	10	30 pz	5 scatole
NB9904	Reggimensola a scomparsa con tassello RG-S 14x145	12	14	140	14	75	10	30 pz	3 scatole
NB9911	Reggimensola a scomparsa con tassello RG-S 14x170	12	14	165	14	75	10	30 pz	3 scatole
NB9928	Reggimensola a scomparsa con tassello RG-S 14x200	12	14	195	14	75	10	30 pz	3 scatole

Disponibile in blister

Installazione a scomparsa di mensole ►

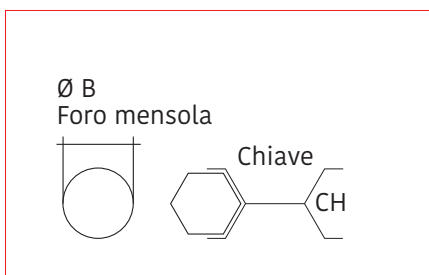

Fissaggi universali in nylon

Ancorante in nylon ad espansione elicoidale ideale per cartongesso , pareti vuote forate, per carichi medio leggeri.

MATERIALI DI SUPPORTO MATTONI FORATI, MATTONE CLS FORATO, CARTONGESSO, PANNELLI IN FIBRA DI LEGNO

TSP - Tassello in nylon solo corpo

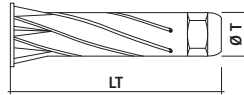

Codice	Descrizione	Ø T mm	LT mm	Scatola singola	Imballo complessivo
NB112002	Tassello TSP in nylon rosso 10X49	10	49	25 pz	10 scatole

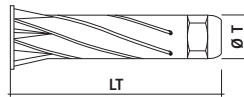

Codice	Descrizione	Ø T mm	LT mm	Scatola singola	Imballo complessivo
NB112015	Tassello TSP in nylon nero 10X59	10	59	25 pz	10 scatole

TSP-T - Tassello in nylon con vite bombata Torx

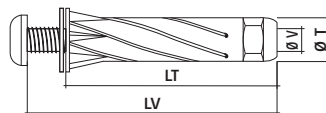

Codice	Descrizione	Ø T mm	LT mm	Ø V mm	LV mm	Scatola singola	Imballo complessivo
NB112000	Tassello TSP in nylon rosso 10X49 con vite Torx 5X55	10	49	5	55	25 pz	10 scatole
NB112001	Tassello TSP in nylon rosso 10x49 con vite Torx 5X80	10	49	5	80	25 pz	10 scatole

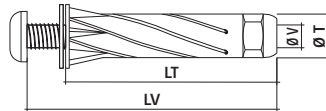

Codice	Descrizione	Ø T mm	LT mm	Ø V mm	LV mm	Scatola singola	Imballo complessivo
NB112011	Tassello TSP in nylon nero 10X59 con vite Torx 5X55	10	59	5	65	25 pz	10 scatole
NB112012	Tassello TSP in nylon nero 10X59 con vite Torx 5X90	10	59	5	90	25 pz	10 scatole

Fissaggi universali in nylon

TSP-P - Tassello in nylon con vite bombata pozi

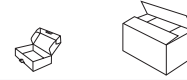
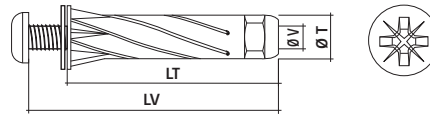

Codice	Descrizione	Ø T mm	LT mm	Ø V mm	LV mm	Scatola singola	Imballo complessivo
NB112003	Tassello TSP in nylon rosso 10x49 con vite pozi 5x65	10	49	5	65	25 pz	10 scatole
NB112004	Tassello TSP in nylon rosso 10x49 con vite pozi 5x80	10	49	5	80	25 pz	10 scatole

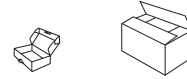
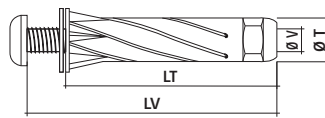

Codice	Descrizione	Ø T mm	LT mm	Ø V mm	LV mm	Scatola singola	Imballo complessivo
NB112013	Tassello TSP in nylon nero 10x59 con vite pozi 5x65	10	59	5	65	25	10 scatole
NB112014	Tassello TSP in nylon nero 10x59 con vite pozi 5x90	10	59	5	90	25	10 scatole

TSP-GM - Tassello in nylon con pitoneria - gancio medio

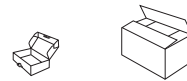
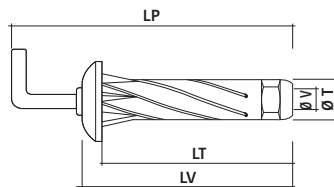

Codice	Descrizione	Ø T mm	LT mm	Ø V mm	LV mm	LP mm	Scatola singola	Imballo complessivo
NB112010	Tassello TSP rosso 10x49 con gancio medio 5x55	10	49	5	55	75	25 pz	10 scatole

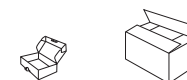
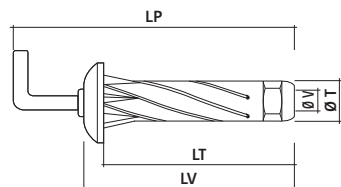

Codice	Descrizione	Ø T mm	LT mm	Ø V mm	LV mm	LP mm	Scatola singola	Imballo complessivo
NB112021	Tassello TSP nero 10x59 con gancio medio 5x55	10	59	5	55	75	25 pz	10 scatole

Fissaggi universali in nylon

MATERIALI DI SUPPORTO MATTONI FORATI, MATTONE CLS FORATO, CARTONGESSO, PANNELLI IN FIBRA DI LEGNO

TSP-SV - Tassello in nylon con vite svasata Torx

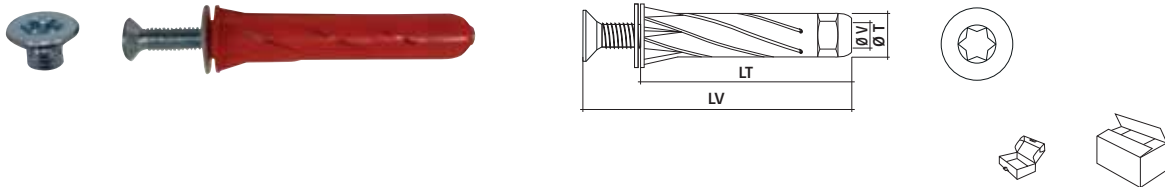

Codice	Descrizione	Ø T mm	LT mm	Ø V mm	LV mm	Scaola singola	Imballo complessivo
NB112005	Tassello TSP in nylon rosso 10X49 con vite svasata Torx 5X65	10	49	5	65	25 pz	10 scatole
NB112006	Tassello TSP in nylon rosso 10X49 con vite svasata Torx 5X89	10	49	5	89	25 pz	10 scatole

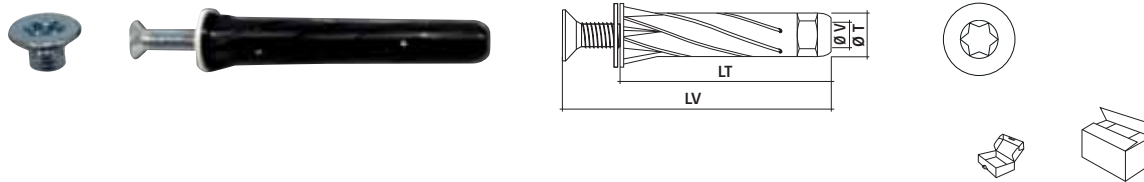

Codice	Descrizione	Ø T mm	LT mm	Ø V mm	LV mm	Busta singola	Imballo complessivo
NB112016	Tassello TSP in nylon nero 10X59 con vite svasata Torx 5X75	10	59	5	75	25 pz	10 scatole
NB112017	Tassello TSP in nylon nero 10X59 con vite svasata Torx 5X90	10	59	5	90	25 pz	10 scatole

TSP-TP - Tassello con prolunga in nylon con vite svasata Torx

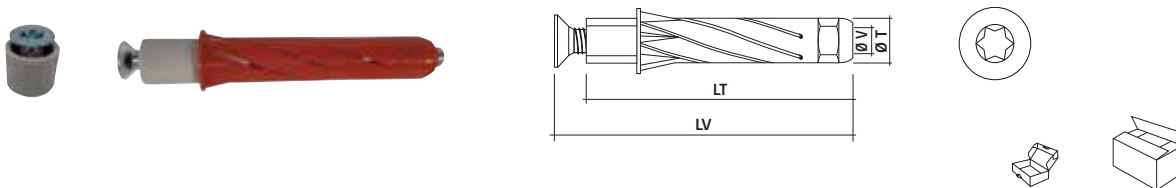

Codice	Descrizione	Ø T mm	LT mm	Ø V mm	LV mm	Scatola singola	Imballo complessivo
NB112007	Tassello TSP con prolunga rosso 10X49 con vite svasata Torx 5x65	10	49	5	65	25 pz	10 scatole

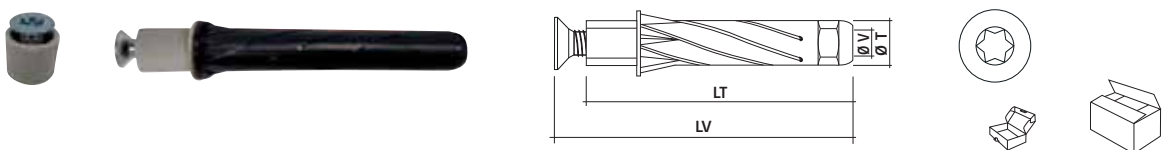

Codice	Descrizione	Ø T mm	LT mm	Ø L mm	LV mm	Scatola singola	Imballo complessivo
NB112018	Tassello TSP con prolunga rosso 10X59 con vite svasata Torx 10x75	10	59	10	75	25 pz	10 scatole

Fissaggi universali in nylon

TSP-OA - Tassello in nylon con pitoneria - occhio aperto

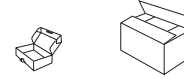
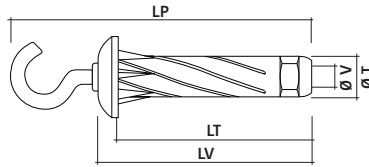

Codice	Descrizione	Ø T mm	LT mm	Ø V mm	LV mm	LP mm	Scatola singola	Imballo complessivo
NB112009	Tassello TSP rosso 10x49 con occhio aperto 5x55	10	49	5	55	87	25 pz	10 scatole

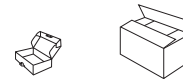
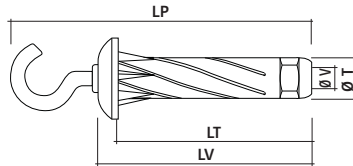

Codice	Descrizione	Ø T mm	LT mm	Ø V mm	LV mm	LP mm	Scatola singola	Imballo complessivo
NB112020	Tassello TSP nero 10x59 con occhio aperto 5x55	10	59	5	55	87	25 pz	10 scatole

TSP-OC - Tassello in nylon con pitoneria - occhio chiuso

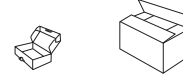
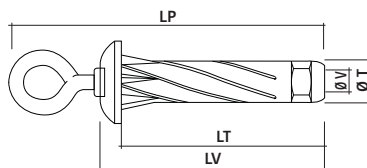

Codice	Descrizione	Ø T mm	LT mm	Ø V mm	LV mm	LP mm	Scatola singola	Imballo complessivo
NB112008	Tassello TSP rosso 10x49 con occhio chiuso 5x55	10	59	5	55	87	25 pz	10 scatole

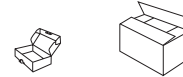
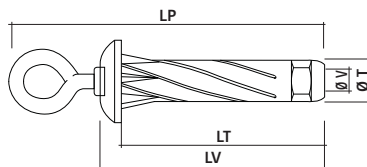

Codice	Descrizione	Ø T mm	LT mm	Ø V mm	LV mm	LP mm	Scatola singola	Imballo complessivo
NB112019	Tassello TSP nero 10x59 con occhio chiuso 5x55	10	59	5	55	87	25 pz	10 scatole

Fissaggi universali in acciaio

Completi di pitoneria

Ancoranti in acciaio ad espansione, ideati per fissaggi su materiali compatti per installazioni distanziate per carichi medio leggeri. Fissaggio di lampade, pensili, quadri, impianti di antifurto, assi di legno, interruttori, accessori bagno, armadietti a muro, tende e riloghe, ecc.

MATERIALI DI SUPPORTO CALCESTRUZZO, PIETRA NATURALE, MATTONI PIENI, MATTONE CLS PIENO

FUA-V - Tassello universale in acciaio con vite metrica

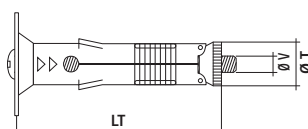

Codice	Descrizione	Ø T mm	LT mm	Ø V mm	LV mm	Scatola singola	Imballo complessivo
NB7481	Tassello universale FUA-V in acciaio 8x35 con vite metrica 4x40	8	35	4	40	200 pz	5 scatole
NB7498	Tassello universale FUA-V in acciaio 9x40 con vite metrica 5x45	9	40	5	45	100 pz	5 scatole



Disponibile in blister



Disponibile in secchiello

FUA-GC - Tassello universale in acciaio con pitoneria - gancio corto

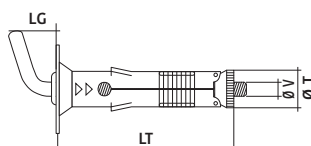

Codice	Descrizione	Ø T mm	LT mm	Ø V mm	LV mm	LG mm	Scatola singola	Imballo complessivo
NB7504	Tassello universale FUA-GC in acciaio 8x35 con gancio corto 4x40	8	35	4	40	7	200 pz	5 scatole
NB7511	Tassello universale FUA-GC in acciaio 9x40 con gancio corto 5x45	9	40	5	45	7	100 pz	5 scatole



Disponibile in blister



Disponibile in secchiello

FUA-GM - Tassello universale in acciaio con pitoneria - gancio medio

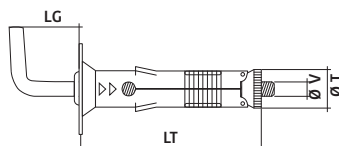

Codice	Descrizione	Ø T mm	LT mm	Ø V mm	LV mm	LG mm	Scatola singola	Imballo complessivo
NB7528	Tassello universale FUA-GM in acciaio 8x35 con gancio medio 4x40	8	35	4	40	10	200 pz	5 scatole
NB7535	Tassello universale FUA-GM in acciaio 9x40 con gancio medio 5x45	9	40	5	45	10	100 pz	5 scatole



Disponibile in blister



Disponibile in secchiello

Fissaggi universali in acciaio

FUA-GL - Tassello universale in acciaio con pitoneria - gancio lungo

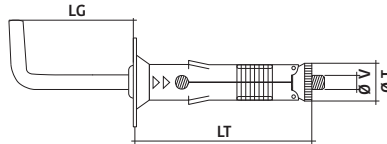
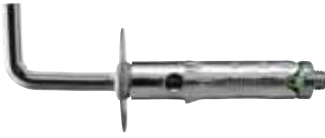

Codice	Descrizione	Ø T mm	LT mm	Ø V mm	LV mm	LG mm	Scatola singola	Imballo complessivo
NB7542	Tassello universale FUA-GL in acciaio 8x35 con gancio lungo 4x40	8	35	4	40	20	200 pz	5 scatole
NB7559	Tassello universale FUA-GL in acciaio 9x40 con gancio lungo 5x45	9	40	5	45	20	100 pz	5 scatole

FUA-OA - Tassello universale in acciaio con pitoneria - occhiolo aperto

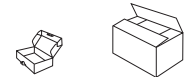
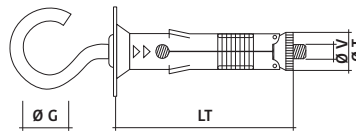

Codice	Descrizione	Ø T mm	LT mm	Ø V mm	LV mm	Ø G mm	Scatola singola	Imballo complessivo
NB7566	Tassello FUA-OA in acciaio 8x35 con occhiolo aperto 4x40	8	35	4	40	12	200 pz	5 scatole
NB7573	Tassello FUA-OA in acciaio 9x40 con occhiolo aperto 5x45	9	40	5	45	12	100 pz	5 scatole

FUA-OC - Tassello universale in acciaio con pitoneria - occhiolo chiuso

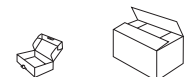
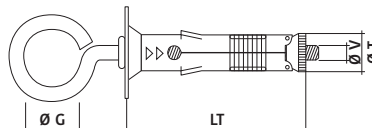

Codice	Descrizione	Ø T mm	LT mm	Ø V mm	LV mm	Ø G mm	Scatola singola	Imballo complessivo
NB7580	Tassello FUA-OC in acciaio 8x35 con occhiolo chiuso 4x40	8	35	4	40	12	200 pz	5 scatole
NB7597	Tassello FUA-OC in acciaio 9x40 con occhiolo chiuso 5x45	9	40	5	45	12	100 pz	5 scatole

Fissaggi universali in acciaio

Completi di pitoneria

MATERIALI DI SUPPORTO CALCESTRUZZO, PIETRA NATURALE, MATTONI PIENI, MATTONE CLS PIENO

FUA-DD - Tassello universale in acciaio con vite metrica e doppio dado

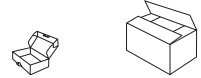
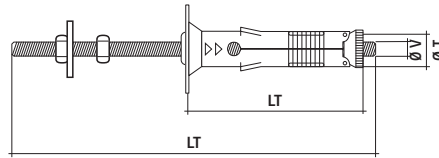

Codice	Descrizione	Ø T mm	LT mm	Ø V mm	LV mm	Scatola singola	Imballo complessivo
NB7627	Tassello FUA-DD in acciaio 8x35 con vite metrica 4x75 e doppio dado	8	35	4	75	100 pz	5 scatole
NB7634	Tassello FUA-DD in acciaio 9x40 con vite metrica 5x80 e doppio dado	9	40	5	80	100 pz	5 scatole

FUA-DDC - Tassello universale in acciaio con vite metrica e doppio dado corto

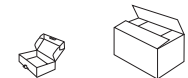
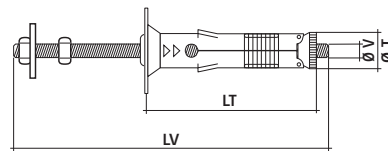

Codice	Descrizione	Ø T mm	LT mm	Ø V mm	LV mm	Scatola singola	Imballo complessivo
NB7610	Tassello FUA-DD in acciaio 10x25 con vite metrica 5x75 e doppio dado corto	5	25	5	75	200 pz	2 scatole
NB52139	Tassello FUA-DD in acciaio 10x20 con vite metrica 6x60 e doppio dado corto	6	20	6	60	200 pz	5 scatole



◀ Installazione accessori bagno

Fissaggi universali in acciaio

Con vite

Ancoranti in acciaio mini, ad espansione idonei per fissaggi su materiali compatti per carichi leggeri. Fissaggio di lampade, quadri, impianti di antifurto, assi di legno, interruttori, accessori bagno, armadietti a muro, tende ecc.,

MATERIALI DI SUPPORTO CALCESTRUZZO, PIETRA NATURALE, MATTONI PIENI, MATTONE CLS PIENO

AC-V - Tassello mini in acciaio con vite metrica

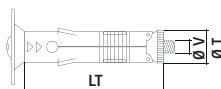

Confezioni standard

Codice	Descrizione	Ø T mm	LT mm	Ø V mm	LV mm	Scatola singola	Imballo complessivo
NB7832	Tassello AC-V mini in acciaio 6x30 con vite metrica 3x35	6	30	3	35	50 pz	14 scatole

Disponibile in blister

Confezioni industriali

Codice	Descrizione	Ø T mm	LT mm	Ø V mm	LV mm	Scatola singola	Imballo pallet
NB89050	Bulk tassello AC-V mini in acciaio 6x30 con vite metrica 3x35	6	30	3	35	3.000 pz	44 scatole

AC-G - Tassello mini in acciaio con pitoneria - gancio corto

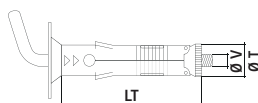

Confezioni standard

Codice	Descrizione	Ø T mm	LT mm	Ø V mm	LV mm	Scatola singola	Imballo complessivo
NB7849	Tassello mini in acciaio AC-G 6x30 con pitoneria gancio corto 3x35	6	30	3	35	50 pz	14 scatole

Disponibile in blister

Confezioni industriali

Codice	Descrizione	Ø T mm	LT mm	Ø V mm	LV mm	Scatola singola	Imballo pallet
NB89067	Bulk tassello mini in acciaio AC-G 6x30 con pitoneria gancio corto 3x35	6	30	3	35	3.000 pz	44 scatole

AC-O - Tassello mini in acciaio con pitoneria - occhiolo chiuso

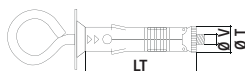

Confezioni standard

Codice	Descrizione	Ø T mm	LT mm	Ø V mm	LV mm	Scatola singola	Imballo complessivo
NB7856	Tassello mini in acciaio AC-O 6x30 con occhiolo chiuso 3x35	6	30	3	35	50	14 scatole

Disponibile in blister

Confezioni industriali

Codice	Descrizione	Ø T mm	LT mm	Ø V mm	LV mm	Scatola singola	Imballo pallet
NB89074	Bulk tassello mini in acciaio AC-O 6x30 con occhiolo chiuso 3x35	6	30	3	35	3.000 pz	44 scatole

Fissaggi per cartongesso

Ancorante in acciaio, zamak o nylon per installazioni distanziate di pendinature per controsoffitti, pannelli in cartongesso e calcestruzzo cellulare sia rigidi che flessibili su materiali compatti.

MATERIALI DI SUPPORTO CARTONGESSO, CALCESTRUZZO CELLULARE, CONTROSOFFITTI

SPV - Tassello autoforante in nylon per cartongesso con vite truciolare DIN 7505/A

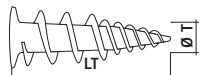

Codice	Descrizione	Ø T mm	LT mm	Ø V mm	LV mm	Scatola singola	Imballo complessivo
NB5913	Tassello autoforante in nylon SP 6x37	6	37	-	-	100 pz	10 scatole
NB5920	Tassello autoforante in nylon SPV 6x37 con vite TSP 4x30	6	37	4	30	100 pz	10 scatole



Disponibile in blister

Confezioni industriali



Codice	Descrizione	Ø T mm	LT mm	Ø V mm	LV mm	Scatola singola	Imballo pallet
NB49030	Bulk tassello autoforante in nylon SP 6x37	6	37	-	-	15.000 pz	16

SPZ - Tassello autoforante in zamak per cartongesso con vite truciolare DIN 7505/A

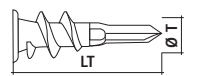

Codice	Descrizione	Ø T mm	LT mm	Ø V mm	LV mm	Scatola singola	Imballo complessivo
NB5883	Tassello autoforante in zamak SPZ 6x37	6	37	-	-	100 pz	10 scatole
NB5890	Tassello autoforante in zamak SPZ 6x37 con vite TSP 4,5X40	6	37	4,5	40	100 pz	10 scatole

Confezioni industriali



Codice	Descrizione	Ø T mm	LT mm	Ø V mm	LV mm	Scatola singola	Imballo pallet
NB49047	Bulk tassello autoforante in zamak SPZ 6x37	6	37	-	-	3.000 pz	44

Fissaggi per controsoffitti

Ancorante in acciaio, per installazioni distanziate di pendinature per controsoffitti sia rigidi che flessibili su materiali compatti.

MATERIALI DI SUPPORTO CALCESTRUZZO

TC - Tassello in acciaio per controsoffitti

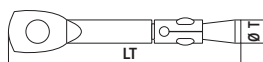

Codice	Descrizione	Ø T mm	LT mm	Scatola singola	Imballo complessivo
NB3610	Tassello in acciaio per controsoffitti TC 6x50	6	50	100 pz	10 scatole
NB3612	Tassello in acciaio per controsoffitti TC 6x60	6	60	100 pz	10 scatole

Viti autoforanti e autofilettanti

Viti per profili e pannelli di cartongesso

V-ATL - Vite zincata PC autoforante con testa larga impronta Philips PH 2

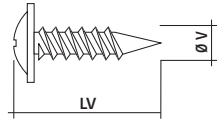

Codice	Descrizione	Ø V mm	LV mm	Scatola singola	Imballo complessivo
NB6071	Vite zincata PC autoforante V-ATL 4,2x13	4,2	13	1.000 pz	10 scatole

V-ATL - Vite zincata PT autofilettante con testa larga impronta Philips PH 2

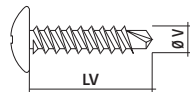

Codice	Descrizione	Ø V mm	LV mm	Scatola singola	Imballo complessivo
NB66150	Vite zincata PT autofilettante V-ATL 4,2x13	4,2	13	1.000 pz	10 scatole

V-FOSF - Vite fosfatata con punta chiodo impronta Philips PH 2

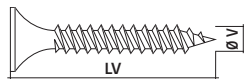

Codice	Descrizione	Ø V mm	LV mm	Scatola singola	Imballo complessivo
NB6033	Vite fosfatata V-FOSF 3,5x25 punta chiodo	3,5	25	1.000 pz	10 scatole
NB6040	Vite fosfatata V-FOSF 3,5x35 punta chiodo	3,5	35	1.000 pz	5 scatole
NB98144	Vite fosfatata V-FOSF 3,5x45 punta chiodo	3,5	45	1.000 pz	5 scatole
NB6055	Vite fosfatata V-FOSF 3,5x55 punta chiodo	3,5	55	1.000 pz	10 scatole
NB6070	Vite fosfatata V-FOSF 3,5x70 punta chiodo	3,5	70	1.000 pz	10 scatole

V-FOSF - Vite fosfatata con punta trapano impronta Philips PH 2

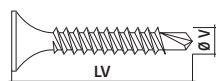

Codice	Descrizione	Ø V mm	LV mm	Scatola singola	Imballo complessivo
NB6057	Vite fosfatata V-FOSF 3,5x25 punta trapano	3,5	25	1.000 pz	10 scatole
NB6064	Vite fosfatata V-FOSF 3,5x35 punta trapano	3,5	35	1.000 pz	5 scatole

Disponibile in blister

Pareti vuote e cartongesso

Ancorante in nylon di tipo non passante idoneo per cartongesso e pareti vuote, per carichi leggeri.

MATERIALI DI SUPPORTO MATTONI FORATI, MATTONE CLS FORATO CARTONGESSO



HAV - Ancorante in nylon non passante per carichi leggeri

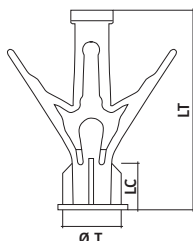

Codice	Descrizione	Ø T mm	LT mm	Ø V mm	LV mm	LC mm	Scatola singola	Imballo complessivo
NB5927	Ancorante HAV in nylon non passante 8X38	8	38	-	-	10	100 pz	5 scatole
NB5934	Ancorante HAV in nylon non passante 8X42	8	42	-	-	17	100 pz	5 scatole
NB5937	Ancorante HAV in nylon non passante 10x38	10	38	-	-	10	100 pz	5 scatole
NB5944	Ancorante HAV in nylon non passante 17x47	10	47	-	-	17	100 pz	5 scatole

Confezioni industriali



Codice	Descrizione	Ø T mm	LT mm	Ø V mm	LV mm	Busta singola pz	Imballo pallet complessivo
NB49023	Bulk ancorante HAV in nylon non passante 10x38	10	38	-	-	8.000 pz	16
NB49016	Bulk ancorante HAV in nylon non passante 17x47	17	47	4,5	40	7.000 pz	16

HAV-V - Ancorante in nylon non passante con vite truciolare DIN 7505/A

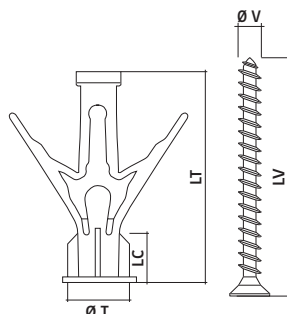

Codice	Descrizione	Ø T mm	LT mm	Ø V mm	LV mm	LC mm	Busta singola	Imballo complessivo
NB5929	Ancorante HAV-V in nylon 8X10 con vite TSP 3,50X40	8	10	3,5	40	10	100 pz	5 scatole
NB5935	Ancorante HAV-V in nylon 8X17 con vite TSP 3,50X50	8	17	3,5	50	17	100 pz	5 scatole
NB5982	Ancorante HAV-V in nylon 10 con vite TSP 4x50	10	38	4	50	10	100 pz	5 scatole
NB5999	Ancorante HAV-V in nylon 17 con vite TSP 4x60	10	47	4	60	17	100 pz	5 scatole

Fissaggi per tubi

Ancorante in nylon rapido a battuta, per materiali pieni, semipieni, forati e lastre di cartongesso

MATERIALI DI SUPPORTO CALCESTRUZZO, PIETRA NATURALE, MATTONE PIENO, MATTONE FORATO, LASTRA DI CARTONGESSO

TUBE-FIX - Tassello in nylon per fissaggio di tubi

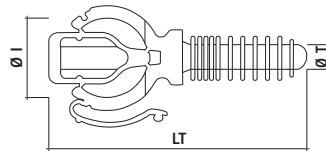
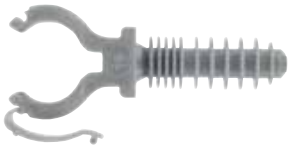

Codice	Descrizione	Ø T mm	LT mm	Ø I mm	Scatola singola	Imballo complessivo
NB87292	Tassello TUBE-FIX in nylon per fissaggio di tubi Ø16	8	57	16	100 pz	5 scatole
NB87308	Tassello TUBE-FIX in nylon per fissaggio di tubi Ø20	8	57	20	100 pz	5 scatole
NB87315	Tassello TUBE-FIX in nylon per fissaggio di tubi Ø22	8	57	22	100 pz	2 scatole

GRAP-FIX - Tassello singolo in nylon per fissaggio di tubi

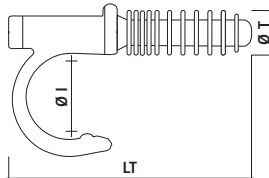

Codice	Descrizione	Ø T mm	LT mm	Ø I mm	Scatola singola	Imballo complessivo
NB87230	Tassello GRAP-FIX in nylon singolo per fissaggio di tubi Ø16	8	55	16	100 pz	5 scatole
NB87247	Tassello GRAP-FIX in nylon singolo per fissaggio di tubi Ø20	8	55	20	100 pz	2 scatole
NB87254	Tassello GRAP-FIX in nylon singolo per fissaggio di tubi Ø25	8	55	25	100 pz	2 scatole

GRAP-FIX - Tassello doppio in nylon per fissaggio di tubi

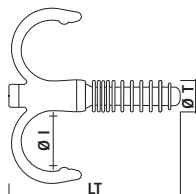
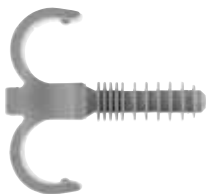

Codice	Descrizione	Ø T mm	LT mm	Ø I mm	Scatola singola	Imballo complessivo
NB87261	Tassello GRAP-FIX in nylon doppio per fissaggio di tubi Ø16	8	55	16	100 pz	2 scatole
NB87278	Tassello GRAP-FIX in nylon doppio per fissaggio di tubi Ø20	8	55	20	100 pz	2 scatole
NB87285	Tassello GRAP-FIX in nylon doppio per fissaggio di tubi Ø25	8	55	25	100 pz	2 scatole

CLIP-FIX - Supporto in nylon per l'installazione di tube-fix e grap-fix su cartongesso

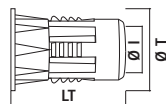

Codice	Descrizione	Ø T mm	Ø I mm	LT mm	Scatola singola	Imballo complessivo
NB87322	Supporto cartongesso CLIP-FIX Ø12 per tassello in nylon linea FIX	12	8	22	100 pz	10 scatole

Fissaggi in acciaio

Ancorante in acciaio di tipo non passante ad espansione idoneo per il fissaggio di carichi leggeri su pannelli in cartongesso, per carichi medio leggeri.

MATERIALI DI SUPPORTO MATTONI FORATI, MATTONE CLS FORATO CARTONGESSO



CPV - Tassello in acciaio con vite bombata Pozi

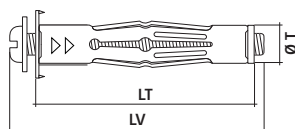

Codice	Descrizione	Ø T mm	LT mm	Ø V mm	LV mm	Scatola singola	Imballo complessivo
NB5996	Tassello CPV in acciaio 8x32 con vite bombata 4x36	8	32	4	36	100 pz	5 scatole
NB5998	Tassello CPV in acciaio 9x37 con vite bombata 5x42	9	37	5	42	100 pz	5 scatole
NB6002	Tassello CPV in acciaio 9x65 con vite bombata 5x70	9	65	5	70	100 pz	5 scatole
NB6019	Tassello CPV in acciaio 10x52 con vite bombata 6x57	10	52	6	57	100 pz	5 scatole
NB6026	Tassello CPV in acciaio 10x65 con vite bombata 6x70	10	65	6	70	100 pz	5 scatole

CPV-B - Tassello in acciaio con vite testa esagonale

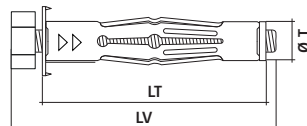

Codice	Descrizione	Ø T mm	LT mm	Ø V mm	LV mm	Scatola singola	Imballo complessivo
NB6028	Tassello CPV-B in acciaio 13x45 con vite testa esagonale 8x50	13	45	8	50	50 pz	5 scatole
NB6030	Tassello CPV-B in acciaio 13x75 con vite testa esagonale 8x50	13	75	8	80	50 pz	5 scatole

PINZA - Per montaggio CPV



Codice	Descrizione	Scatola singola	Imballo complessivo
NB6006	Pinza per tasselli in acciaio CPV fino a 10 mm	1 pz	5 scatole
NB6008	Pinza per tasselli in acciaio CPV-B oltre 10 mm	1 pz	5 scatole

Fissaggi rapidi in nylon

Tassello in nylon con vite premontata a battuta ad installazione controllata, di tipo passante. Ideale per coperture, infissi e impiantistica.



MATERIALI DI SUPPORTO CALCESTRUZZO, PIETRA NATURALE, MATTONI PIENI, MATTONE CLS PIENO, LEGNO

TNSM-RE - Tassello rapido con bordo piatto in nylon con vite zincata a battuta

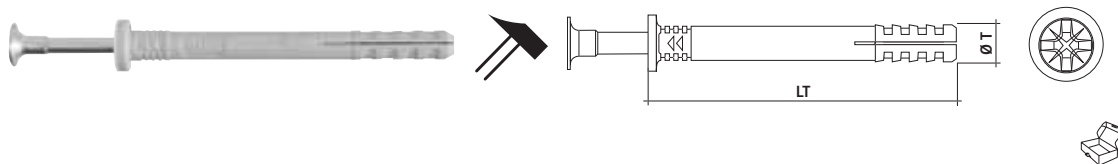

Codice	Descrizione	Ø T mm	LT mm	Scatola singola	Imballo complessivo
NB8983	Tassello TNSM-RE rapido in nylon 5x30 con vite zincata a battuta	5	30	200 pz	10 scatole
NB29827	Tassello TNSM-RE rapido in nylon 5x40 con vite zincata a battuta	5	40	100 pz	10 scatole
NB9003	Tassello TNSM-RE rapido in nylon 6x35 con vite zincata a battuta	6	35	100 pz	10 scatole
NB9010	Tassello TNSM-RE rapido in nylon 6x40 con vite zincata a battuta	6	40	100 pz	10 scatole

TNB - Tassello rapido in nylon testa bombata con vite a battuta per profili di cartongesso

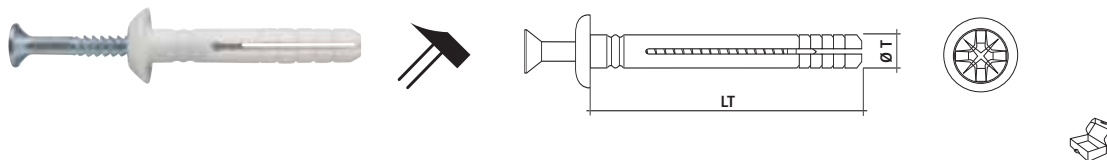

Codice	Descrizione	Ø T mm	LT mm	Scatola singola	Imballo complessivo
NB9294	Tassello TNB rapido in nylon 5x25 con vite a battuta	5	25	100 pz	10 scatole
NB9300	Tassello TNB rapido in nylon 6x25 con vite a battuta	6	25	100 pz	10 scatole
NB9317	Tassello TNB rapido in nylon 6x40 con vite a battuta	6	40	100 pz	10 scatole

NGB - Tassello rapido in nylon non passante con vite a brugola per calcestruzzo cellulare

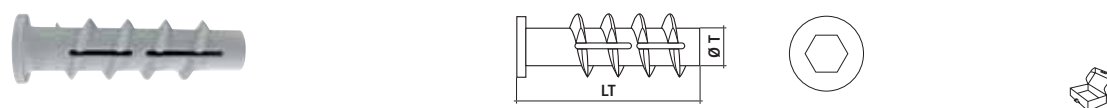

Codice	Descrizione	Ø foro mm	Ø T mm	LT mm	Scatola singola	Imballo complessivo
NB97543	Tassello NGB rapido in nylon 4x50 con vite a brugola 4	10	4	50	100 pz	5 scatole
NB97550	Tassello NGB rapido in nylon 6x50 con vite a brugola 6	10	6	50	100 pz	5 scatole
NB97567	Tassello NGB rapido in nylon 8x60 con vite a brugola 8	12	8	60	50 pz	5 scatole
NB97574	Tassello NGB rapido in nylon 10x70 con vite a brugola 10	14	10	70	50 pz	5 scatole

Ancore e fissaggi basculanti

Ancorine a molla in acciaio zincato, per montaggi di elementi leggeri.

MATERIALI DI SUPPORTO MATTONI FORATI, MATTONE CLS FORATO, CARTONGESSO, PIGNATTE.

AK-V - Ancore in acciaio con vite



Codice	Descrizione	LA aperta mm	Ø foro mm	Ø V mm	LV mm	Scatola singola	Imballo complessivo
NB3803	Ancora AK-V in acciaio con vite M4	39,5	12	4	74	100 pz	5 scatole
NB72595	Ancora AK-V in acciaio con vite M5	50,5	14	5	85	50 pz	5 scatole
NB3728	Ancora AK-V in acciaio con vite M6	50,5	19	6	81	50 pz	5 scatole
NB72600	Ancora AK-V in acciaio con vite M5	53	15	5	-	50 pz	5 scatole



Disponibile in blister



Disponibile in secchiello

AK-DC - Ancore in acciaio con dado cieco

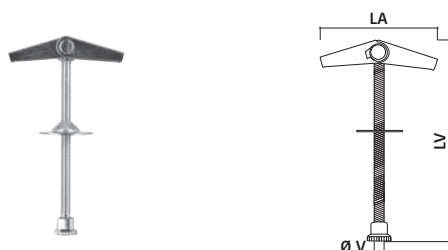

Codice	Descrizione	LA aperta mm	Ø foro mm	Ø V mm	LV mm	Scatola singola	Imballo complessivo
NB3800	Ancora AK-DC in acciaio con dado cieco M4	39,5	12	4	-	100 pz	5 scatole



Disponibile in blister



Disponibile in secchiello

AK-DD - Ancore in acciaio con doppio dado

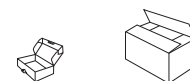
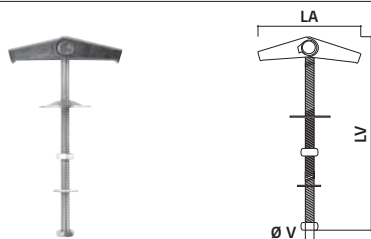

Codice	Descrizione	LA aperta mm	Ø foro mm	Ø V mm	LV mm	Scatola singola	Imballo complessivo
NB3810	Ancora AK-DD in acciaio A con doppio dado M4	40	12	4	80,5	100 pz	5 scatole
NB72601	Ancora AK-DD in acciaio con doppio dado M5	53	16	5	100	50 pz	5 scatole
NB3735	Ancora AK-DD in acciaio con doppio dado M6	50	14	6	70	50 pz	5 scatole
NB3711	Ancora AK-DD in acciaio con doppio dado M8	74	20	8	100	25 pz	5 scatole
NB3910	Ancora AK-DD in acciaio con doppio dado M10	74	14	10	160	50 pz	5 scatole



Disponibile in blister



Disponibile in secchiello

N.B.: Alcune misure possono variare

Ancore e fissaggi basculanti

AK-OA - Ancore in acciaio con occhiolo aperto

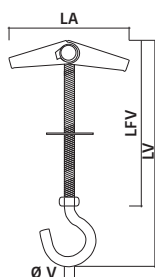

Codice	Descrizione	LA aperta mm	Ø foro mm	Ø V mm	LV mm	LFV mm	Scatola singola	Imballo complessivo
NB3834	Ancora AK-OA in acciaio con occhiolo aperto M4	40	12	4	100	74	100 pz	5 scatole
NB72625	Ancora AK-OA in acciaio con occhiolo aperto M5	50,5	14	5	96	70	100 pz	5 scatole

Disponibile in blister

Disponibile in secchiello

AK-OC - Ancore in acciaio con occhiolo chiuso

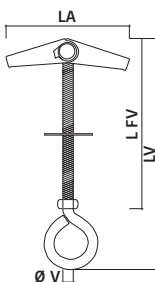

Codice	Descrizione	LA aperta mm	Ø foro mm	Ø V mm	L V mm	L FV mm	Scatola singola	Imballo complessivo
NB3827	Ancora AK-OC in acciaio con occhiolo chiuso M4	40	12	4	95	70	100 pz	5 scatole
NB72618	Ancora AK-OC in acciaio con occhiolo chiuso M5	50,5	14	5	96	69	50 pz	5 scatole
NB72630	Ancora AK-OC in acciaio con occhiolo chiuso M6	48	17	6	90	65	50 pz	5 scatole

Disponibile in blister

Disponibile in secchiello

AK-R - Ricambio per ancora con nottolino piatto



Codice	Descrizione	LA aperta mm	Ø foro mm	Ø V mm	Scatola singola	Imballo
NB3919	Ricambio AK-R per ancora con nottolino piatto M4	38	11	4	100 pz	5 scatole
NB3926	Ricambio AK-R per ancora con nottolino piatto M8	50,5	15	8	100 pz	5 scatole
NB3933	Ricambio AK-R per ancora con nottolino piatto M6	54,5	17	6	100 pz	5 scatole
NB3940	Ricambio AK-R per ancora con nottolino piatto M8	75,5	-	8	100 pz	5 scatole
NB3934	Ricambio AK-RR per ancora con nottolino cilindrico M6	48	17	6	100 pz	5 scatole
NB3900	Ricambio AK-R per ancora con nottolino piatto M10	74	30	10	50 pz	5 scatole

N.B.: Alcune misure possono variare

Fissaggi basculanti

Bascula in acciaio zincato, per montaggi di elementi medio pesanti.

MATERIALI DI SUPPORTO MATTONI FORATI, MATTONE CLS FORATO, CARTONGESSO, PIGNATTE

BK-V - Ancora basculante in acciaio con vite

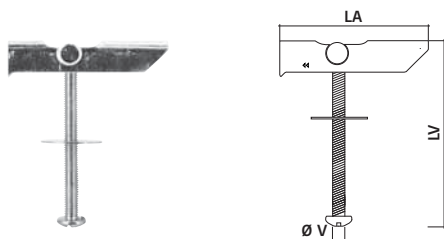

Codice	Descrizione	LA aperta mm	Ø foro mm	Ø V mm	LV mm	Scatola singola	Imballo complessivo
NB3841	Ancora basculante BK-V in acciaio M6	64,20	16,5	6	79	50 pz	5 scatole
NB72850	Ancora basculante BK-V in acciaio M8	72	20	8	100	50 pz	5 scatole

BK-DD - Ancora basculante in acciaio con doppio dado

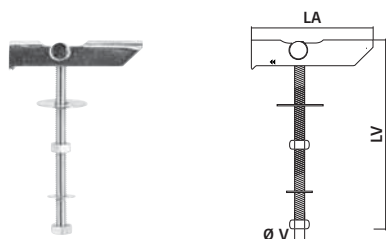

Codice	Descrizione	LA aperta mm	Ø foro mm	Ø V mm	LV mm	Scatola singola	Imballo complessivo
NB3858	Ancora basculante BK-DD in acciaio M6 con doppio dado	64,20	16,5	6	100	50 pz	5 scatole
NB72858	Ancora basculante BK-DD in acciaio M8 con doppio dado	72	20	8	160	50 pz	5 scatole
NB3960	Ancora basculante BK-DD in acciaio M10 con doppio dado	90	22	10	120	50 pz	5 scatole

Disponibile in blister

Disponibile in secchiello

BK-OC - Ancora basculante in acciaio con occhio chiuso

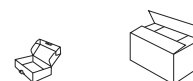
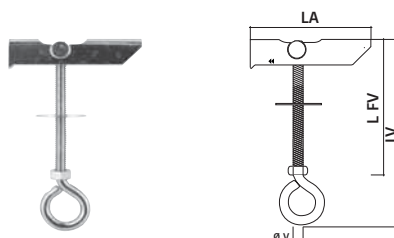

Codice	Descrizione	LA aperta mm	Ø foro mm	Ø V mm	LV mm	L FV mm	Scatola singola	Imballo complessivo
NB3865	Ancora basculante BK-OC in acciaio M6 occhio chiuso	64,20	16,5	6	100	72,5	50 pz	5 scatole

N.B.: Alcune misure possono variare

Fissaggi basculanti

BK-OA - Ancora basculante in acciaio con occhiolo aperto

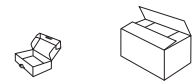
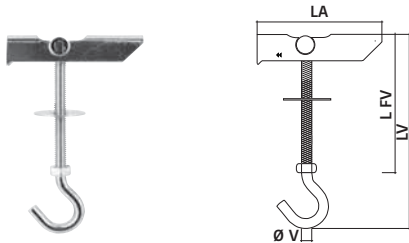

Codice	Descrizione	LA aperta mm	Ø foro mm	Ø V mm	LV mm	L FV mm	Scatola singola	Imballo complessivo
NB3872	Ancora basculante BK-OA in acciaio M6 occhiolo aperto	64,20	16,5	6	100	72,5	50 pz	5 scatole
NB72872	Ancora basculante BK-OA in acciaio M8 occhiolo aperto	72	20	8	160	-	50 pz	5 scatole

Disponibile in blister Disponibile in secchiello

BK-R - Ricambio ancore basculanti



Codice	Descrizione	LA aperta mm	Ø foro mm	Ø V mm	Scatola singola	Imballo complessivo
NB3889	BK-R ricambio ancore basculanti M6	64,2	16	6	100 pz	5 scatole
NB72526	BK-R ricambio ancore basculanti M8	72	20	8	100 pz	5 scatole
NB3950	BK-R ricambio ancore basculanti M10	90	22	10	50 pz	5 scatole



◀ Installazioni sospese a soffitto

N.B.: Alcune misure possono variare

Fissaggi prolungati per serramenti

Tassello in nylon NC-PS per fissaggi prolungati con particolare geometria del corpo espandente a 4 settori che consente un'espansione differenziata a seconda del tipo di materiale di posa in opera. Indicato per fissaggi di profili, serramenti, coperture in legno e in acciaio, listelli di legno, controtelai, pareti ventilate, etc

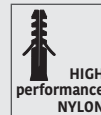

MATERIALI DI SUPPORTO CALCESTRUZZO, PIETRA NATURALE, MATTONI PIENI, MATTONE CLS PIENO, MATTONI FORATI, MATTONE CLS FORATO

NC-PS V - Tassello in nylon prolungato con vite pozi

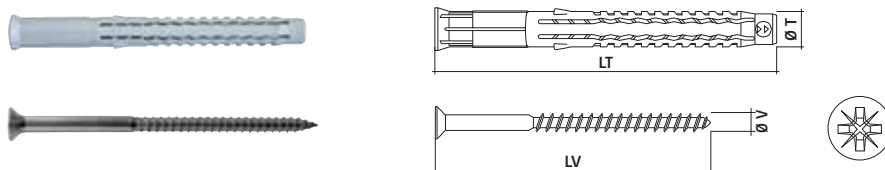

Codice	Descrizione	Ø T mm	LT mm	Ø V mm	Ø LV mm	Scatola singola	Imballo complessivo
NB175100	Tassello NC-PS V in nylon prolungato 8x80 con vite Pozi 5,5x85	8	80	5,5	85	100 pz	5 scatole
NB175105	Tassello NC-PS V in nylon prolungato 8x100 con vite Pozi 5,5x105	8	100	5,5	105	100 pz	5 scatole
NB175110	Tassello NC-PS V in nylon prolungato 8x120 con vite Pozi 5,5x125	8	120	5,5	125	100 pz	5 scatole
NB175115	Tassello NC-PS V in nylon prolungato 8x140 con vite Pozi 5,5x145	8	140	5,5	145	50 pz	5 scatole

NC-PS T - Tassello in nylon prolungato con vite Torx

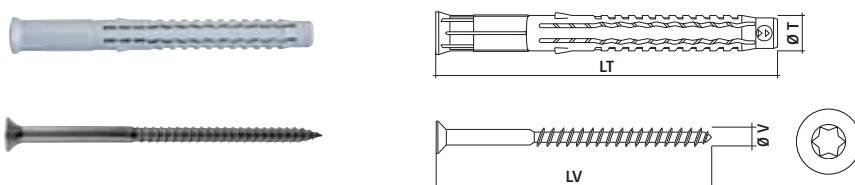

Ø 8 Torx T30/ Ø 10 Torx T40

Codice	Descrizione	Ø T mm	LT mm	Ø V mm	Ø LV mm	Scatola singola	Imballo complessivo
NB175200	Tassello NC-PS T in nylon prolungato 8x80 con vite Torx 5,5x85	8	80	5,5	85	50 pz	5 scatole
NB175205	Tassello NC-PS T in nylon prolungato 8x100 con vite Torx 5,5x105	8	100	5,5	105	50 pz	5 scatole
NB175210	Tassello NC-PS T in nylon prolungato 8x120 con vite Torx 5,5x125	8	120	5,5	125	100 pz	5 scatole
NB175215	Tassello NC-PS T in nylon prolungato 8x140 con vite Torx 5,5x145	8	140	5,5	145	50 pz	5 scatole
NB175300	Tassello NC-PS T in nylon prolungato 10x80 con vite Torx 7x85	10	80	7	85	100 pz	5 scatole
NB175305	Tassello NC-PS T in nylon prolungato 10x100 con vite Torx 7x105	10	100	7	105	50 pz	5 scatole
NB175310	Tassello NC-PS T in nylon prolungato 10x120 con vite Torx 7x125	10	120	7	125	100 pz	5 scatole
NB175315	Tassello NC-PS T in nylon prolungato 10x140 con vite Torx 7x145	10	140	7	145	50 pz	5 scatole
NB175320	Tassello NC-PS T in nylon prolungato 10x160 con vite Torx 7x165	10	160	7	165	100 pz	5 scatole
NB175325	Tassello NC-PS T in nylon prolungato 10x200 con vite Torx 7x205	10	200	7	205	50 pz	5 scatole

NC-PS TE - Tassello in nylon prolungato con vite testa esagonale

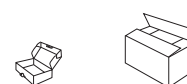
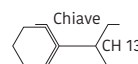
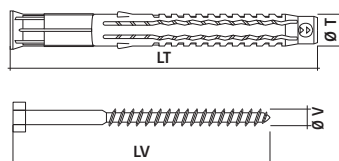
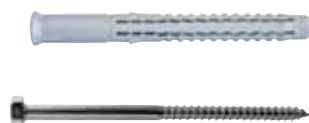

Codice	Descrizione	Ø T mm	LT mm	Ø V mm	Ø LV mm	Scatola singola	Imballo complessivo
NB175400	Tassello NC-PS TE in nylon prolungato 10x80 con vite TE 7x85	10	80	7	85	50 pz	5 scatole
NB175405	Tassello NC-PS TE in nylon prolungato 10x100 con vite TE 7x105	10	100	7	105	50 pz	5 scatole
NB175410	Tassello NC-PS TE in nylon prolungato 10x120 con vite TE 7x125	10	120	7	125	50 pz	5 scatole
NB175415	Tassello NC-PS TE in nylon prolungato 10x140 con vite TE 7x145	10	140	7	145	50 pz	5 scatole
NB175420	Tassello NC-PS TE in nylon prolungato 10x160 con vite TE 7x165	13	160	7	165	50 pz	5 scatole
NB175425	Tassello NC-PS TE in nylon prolungato 10x200 con vite TE 7x205	10	200	7	205	50 pz	5 scatole

NC-PS TEF - Tassello in nylon prolungato con vite testa esagonale flangiata

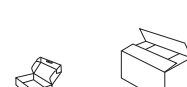
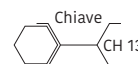
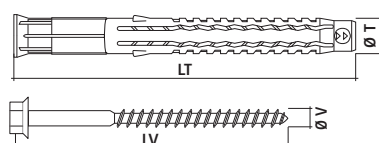

Codice	Descrizione	Ø T mm	LT mm	Ø V mm	Ø LV mm	Scatola singola	Imballo complessivo
NB175500	Tassello NC-PS TEF in nylon prolungato 10x80 con vite TEF 7x85	10	80	7	85	50 pz	5 scatole
NB175505	Tassello NC-PS TEF in nylon prolungato 10x100 con vite TEF 7x105	10	100	7	105	50 pz	5 scatole
NB175510	Tassello NC-PS TEF in nylon prolungato 10x120 con vite TEF 7x125	10	120	7	125	50 pz	5 scatole
NB175515	Tassello NC-PS TEF in nylon prolungato 10x140 con vite TEF 7x145	10	140	7	145	50 pz	5 scatole
NB175520	Tassello NC-PS TEF in nylon prolungato 10x160 con vite TEF 7x165	10	160	7	165	50 pz	5 scatole

NC-PS VTS - Tassello in nylon prolungato con vite antintrusione

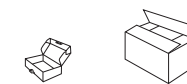
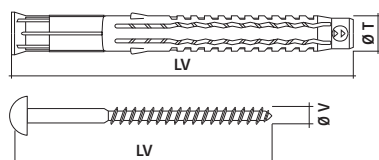

Codice	Descrizione	Ø T mm	LT mm	Ø V mm	Ø LV mm	Scatola singola	Imballo complessivo
NB175600	Tassello NC-PS VTS in nylon prolungato 10x80 con vite T40 antintrus. 7x85	10	80	7	85	50 pz	5 scatole
NB175605	Tassello NC-PS VTS in nylon prolungato 10x100 con vite T40 antintrus. 7x105	10	100	7	105	50 pz	5 scatole
NB175610	Tassello NC-PS VTS in nylon prolungato 10x120 con vite T40 antintrus. 7x125	10	120	7	125	50 pz	5 scatole
NB175615	Tassello NC-PS VTS in nylon prolungato 10x140 con vite T40 antintrus. 7x145	10	140	7	145	50 pz	5 scatole
NB175620	Tassello NC-PS VTS in nylon prolungato 10x160 con vite T40 antintrus. 7x165	10	160	7	165	50 pz	5 scatole

FISSAGGI PROLUNGATI PER SERRAMENTI

Tassello in nylon per fissaggi prolungati con particolare geometria del corpo espandente, a 4 settori che consente un'espansione differenziata a seconda del tipo di materiale di posa in opera. Indicato per fissaggi di profili, serramenti, coperture in legno e in acciaio, listelli di legno, controtelai, pareti ventilate, ecc...



MATERIALI DI SUPPORTO CALCESTRUZZO, PIETRA NATURALE, MATTONI PIENI, MATTONE CLS PIENO, MATTONI FORATI, MATTONE CLS FORATO

NC-L - Tassello in nylon prolungato con vite truciolare DIN 7505/A o solo corpo

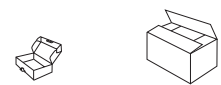
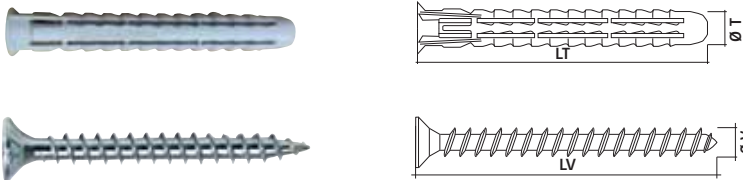

Codice	Descrizione	Ø T mm	LT mm	Ø V mm	Ø LV mm	Scatola singola	Imballo complessivo
NB178440	Tassello prolungato NC-L in nylon 6x50 con vite TSP 4x60	6	50	4	60	100 pz	10 scatole
NB178442	Tassello prolungato NC-L in nylon 6x50 solo corpo	6	50	-	-	100 pz	10 scatole
NB178444	Tassello prolungato NC-L in nylon 8x60 con vite TSP 4,5x70	8	60	4,5	70	50 pz	5 scatole
NB178445	Tassello prolungato NC-L in nylon 8x60 solo corpo	8	60	-	-	50 pz	10 scatole

NC-XL - Tassello in nylon prolungato solo corpo

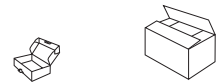

Codice	Descrizione	Ø T mm	LT mm	Scatola singola	Imballo complessivo
NB178980	Tassello NC-XL in nylon prolungato solo corpo 10x240	10	240	50 pz	5 scatole
NB178985	Tassello NC-XL in nylon prolungato solo corpo 10x260	10	260	50 pz	5 scatole

NC-XL V - Tassello in nylon prolungato con vite Pozi

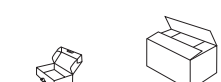
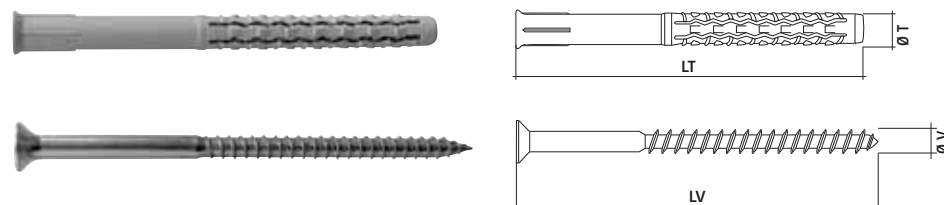

Codice	Descrizione	Ø T mm	LT mm	Ø V mm	Ø LV mm	Scatola singola	Imballo complessivo
NB178000	Tassello NC-XL V in nylon prolungato 6x60 con vite Pozi 4x65	6	60	4	65	100 pz	5 scatole

FISSAGGI PROLUNGATI PER SERRAMENTI

NC-XL T - Tassello in nylon prolungato con viteTorx

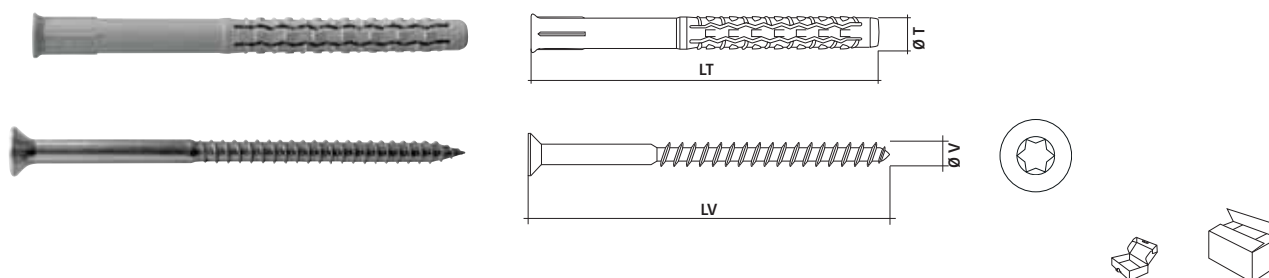

Codice	Descrizione	Ø T mm	LT mm	Ø V mm	Ø LV mm	Scatola singola	Imballo complessivo
NB178220	Tassello NC-XL in nylon prolungato T 8x170 con vite Torx 5,5x175	8	170	5,5	175	50 pz	5 scatole
NB178225	Tassello NC-XL in nylon prolungato T 8x200 con vite Torx 5,5x205	8	200	5,5	205	50 pz	5 scatole
NB178330	Tassello NC-XL in nylon prolungato T 10x240 con vite Torx 7x245	10	240	7	245	50 pz	5 scatole
NB178335	Tassello NC-XL in nylon prolungato T 10x260 con vite Torx 7x265	10	260	7	265	50 pz	5 scatole

NC-XL TE - Tassello in nylon prolungato con vite testa esagonale

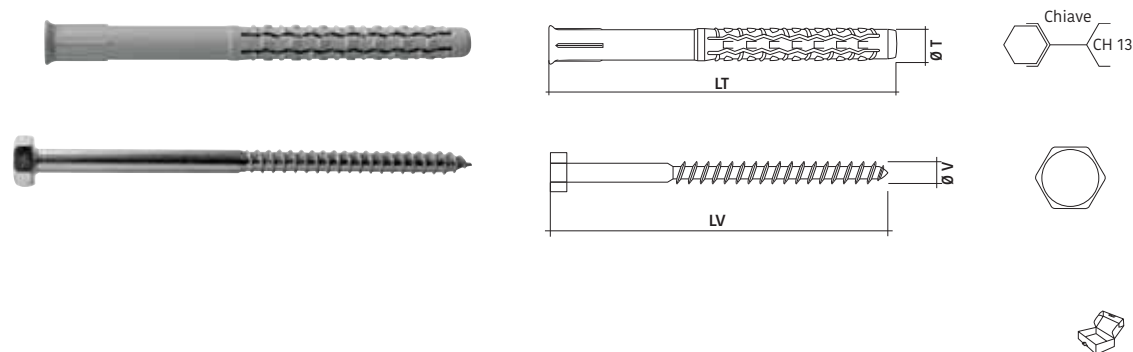

Codice	Descrizione	Ø T mm	LT mm	Ø V mm	Ø LV mm	Scatola singola	Imballo complessivo
NB178430	Tassello NC-XL in nylon prolungato 10x240 con vite TE 7x245	10	240	7	245	50 pz	5 scatole
NB178435	Tassello NC-XL in nylon prolungato 10x260 con vite TE 7x265	10	260	7	265	50 pz	5 scatole

FISSAGGI PROLUNGATI PER SERRAMENTI

Ancorante in nylon ad espansione passante idoneo per il fissaggio dei serramenti su materiali compatti, semi compatti e forati, per carichi medio leggeri. Indicato per fissaggio di profili, serramenti in alluminio, legno, pvc, finestre e porte finestre, infissi, telai, sottostutture di tetti, cancellate, ecc..

MATERIALI DI SUPPORTO CALCESTRUZZO, PIETRA NATURALE, MATTONI PIENI, MATTONE CLS PIENO, MATTONI FORATI, MATTONE CLS FORATO

AF - Tassello passante in nylon con vite premontata

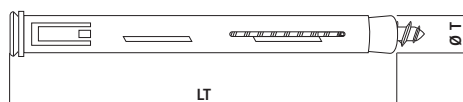

Codice	Descrizione	Ø T mm	LT mm	Ø V mm	Impronta mm	Scatola singola	Imballo complessivo
NB64927	Tassello passante AF in nylon 8x75 con vite premontata	8	75	5	P3	100 pz	5 scatole
NB7030	Tassello passante AF in nylon 8x100 con vite premontata	8	100	5	P3	50 pz	10 scatole
NB7035	Tassello passante AF in nylon 8x120 con vite premontata	8	120	5	P3	50 pz	10 scatole
NB7047	Tassello passante AF in nylon 8x140 con vite premontata	8	140	5	P3	50 pz	5 scatole
NB7054	Tassello passante AF in nylon 10x75 con vite premontata	10	75	6	P3	50 pz	10 scatole
NB7061	Tassello passante AF in nylon 10x100 con vite premontata	10	100	6	P3	50 pz	5 scatole
NB7078	Tassello passante AF in nylon 10x120 con vite premontata	10	120	6	P3	50 pz	5 scatole
NB7085	Tassello passante AF in nylon 10x140 con vite premontata	10	140	6	P3	50 pz	5 scatole
NB7090	Tassello passante AF in nylon 10x165 con vite premontata	10	165	6	P3	50 pz	5 scatole

TNAP - Tassello prolungato in nylon a sei alette

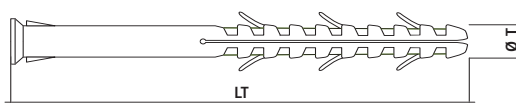

Codice	Descrizione	Ø T mm	LT mm	Scatola singola	Imballo complessivo
NB15790	Tassello prolungato TNAP in nylon 8x80	8	80	100 pz	5 scatole
NB15806	Tassello prolungato TNAP in nylon 8x100	8	100	100 pz	5 scatole
NB15813	Tassello prolungato TNAP in nylon 8x120	8	120	100 pz	5 scatole
NB15820	Tassello prolungato TNAP in nylon 10x80	10	80	100 pz	5 scatole
NB15837	Tassello prolungato TNAP in nylon 10x100	10	100	50 pz	5 scatole
NB15844	Tassello prolungato TNAP in nylon 10x115	10	115	50 pz	5 scatole
NB15851	Tassello prolungato TNAP in nylon 10x135	10	135	50 pz	5 scatole
NB15868	Tassello prolungato TNAP in nylon 10x160	10	160	50 pz	5 scatole
NB8884	Tassello prolungato TNAP in nylon 10x200	10	200	100 pz	2 scatole

FISSAGGI PROLUNGATI PER SERRAMENTI

TNAP-V - Tassello passante in nylon con vite mordente legno Pozi

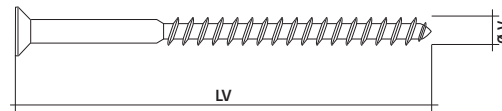
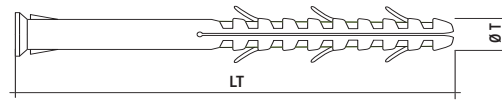

Codice	Descrizione	Ø T mm	LT mm	Ø V mm	Ø LV mm	Impronta mm	Scatola singola	Imballo complessivo
NB8600	Tassello pass. TNAP-V 8x80 con vite mord. legno Pozi 5,5x85	8	80	5,5	85	P3	100 pz	5 scatole
NB8617	Tassello pass. TNAP-V 8x100 con vite mord. legno Pozi 5,5x105	8	100	5,5	105	P3	100 pz	5 scatole
NB8624	Tassello pass. TNAP-V 8x120 con vite mord. legno Pozi 5,5x125	8	120	5,5	125	P3	100 pz	5 scatole
NB8631	Tassello pass. TNAP-V 10x80 con vite mord. legno Pozi 7x85	10	80	7	85	P4	50 pz	5 scatole
NB8648	Tassello pass. TNAP-V 10x100 con vite mord. legno Pozi 7x105	10	100	7	105	P4	50 pz	5 scatole
NB8655	Tassello pass. TNAP-V 10x115 con vite mord. legno Pozi 7x120	10	115	7	120	P4	50 pz	5 scatole
NB8662	Tassello pass. TNAP-V 10x135 con vite mord. legno Pozi 7x140	10	135	7	140	P4	50 pz	5 scatole
NB8679	Tassello pass. TNAP-V 10x160 con vite mord. legno Pozi 7x165	10	160	7	165	P4	25 pz	5 scatole
NB8686	Tassello pass. TNAP-V 10x200 con vite mord. legno Pozi 7x205	10	200	7	205	P4	50 pz	2 scatole

TNAP-T - Tassello passante in nylon con vite mordente legno Torx

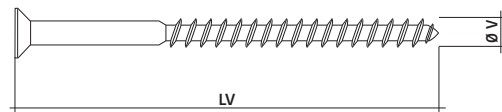
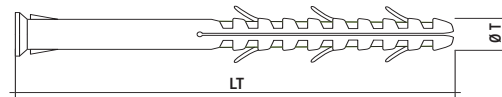

Codice	Descrizione	Ø T mm	LT mm	Ø V mm	Ø LV mm	Impronta mm	Scatola singola	Imballo complessivo
NB63548	Tassello pass. TNAP-T 8x80 con vite Torx 5,5x85	8	80	5,5	85	T30	100 pz	5 scatole
NB63555	Tassello pass. TNAP-T 8x100 con vite Torx 5,5x105	8	100	5,5	105	T30	100 pz	5 scatole
NB63562	Tassello pass. TNAP-T 8x120 con vite Torx 5,5x125	8	120	5,5	125	T30	100 pz	5 scatole
NB63579	Tassello pass. TNAP-T 10x80 con vite Torx 7x85	10	80	7	85	T40	50 pz	5 scatole
NB63586	Tassello pass. TNAP-T 10x100 con vite Torx 7x105	10	100	7	105	T40	50 pz	5 scatole
NB63593	Tassello pass. TNAP-T 10x115 con vite Torx 7x120	10	115	7	120	T40	50 pz	5 scatole
NB63609	Tassello pass. TNAP-T 10x135 con vite Torx 7x140	10	135	7	140	T40	50 pz	5 scatole
NB63616	Tassello pass. TNAP-T 10x160 con vite Torx 7x165	10	160	7	165	T40	25 pz	5 scatole
NB63623	Tassello pass. TNAP-T 10x200 con vite Torx 7x205	10	200	7	205	T40	50 pz	2 scatole
NB63625	Tassello pass. TNAP-T 10x240 con vite Torx 7x245	10	240	7	245	T40	50 pz	2 scatole
NB63631	Tassello pass. TNAP-T 10x280 con vite Torx 7x285	10	280	7	285	T40	50 pz	2 scatole

FISSAGGI PROLUNGATI PER SERRAMENTI

Ancorante universale passante in nylon idoneo per materiali compatti, semicompatti e forati, per carichi medio leggeri. Indicato per fissaggio di listelli in legno, tubi metallici, lampade, guide per tende e riloghe, coperture, profili di serramenti, infissi, accessori elettrici, grate, cordoli stradali, carpenteria leggera, ecc...

MATERIALI DI SUPPORTO CALCESTRUZZO, PIETRA NATURALE, MATTONI PIENI, MATTONE CLS PIENO, MATTONI FORATI, MATTONE CLS FORATO



TNAP-TE - Tassello prolungato in nylon con tirafondo DIN 571

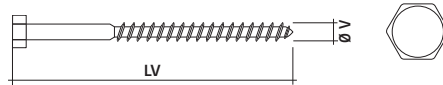
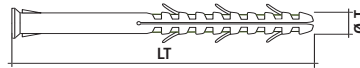

Codice	Descrizione	Ø T mm	LT mm	Ø V mm	Ø LV mm	Impronta mm	Scatola singola	Imballo complessivo
NB8693	Tassello prolungato TNAP-TE in nylon 8x80 con tirafondo 5,5x85	8	80	5,5	85	CH10	100 pz	5 scatole
NB8709	Tassello prolungato TNAP-TE in nylon 8x100 con tirafondo 5,5x105	8	100	5,5	105	CH10	100 pz	5 scatole
NB8716	Tassello prolungato TNAP-TE in nylon 8x120 con tirafondo 5,5x125	8	120	5,5	125	CH10	100 pz	5 scatole
NB8723	Tassello prolungato TNAP-TE in nylon 10x80 con tirafondo 7x85	10	80	7	85	CH12	50 pz	5 scatole
NB8730	Tassello prolungato TNAP-TE in nylon 10x100 con tirafondo 7x105	10	100	7	105	CH12	50 pz	5 scatole
NB8747	Tassello prolungato TNAP-TE in nylon 10x115 con tirafondo 7x120	10	115	7	120	CH12	50 pz	5 scatole
NB8754	Tassello prolungato TNAP-TE in nylon 10x135 con tirafondo 7x140	10	135	7	140	CH12	50 pz	5 scatole
NB8761	Tassello prolungato TNAP-TE in nylon 10x160 con tirafondo 7x165	10	160	7	165	CH12	25 pz	5 scatole
NB8778	Tassello prolungato TNAP-TE in nylon 10x200 con tirafondo 7x205	10	200	7	205	CH12	50 pz	2 scatole

TNAP-VTS - Tassello prolungato in nylon con con vite antintrusione Torx e stellina

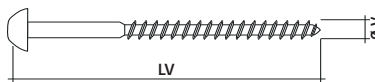
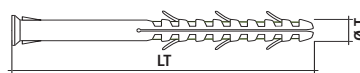

Codice	Descrizione	Ø T mm	LT mm	Ø V mm	Ø LV mm	Impronta mm	Scatola singola	Imballo complessivo
NB74643	Tassello prolungato TNAP-VTS in nylon 10x80 con vite Torx 7x85	10	80	7	85	T40	50 pz	5 scatole
NB74650	Tassello prolungato TNAP-VTS in nylon 10x100 con vite Torx 7x105	10	100	7	105	T40	50 pz	5 scatole
NB74667	Tassello prolungato TNAP-VTS in nylon 10x115 con vite Torx 7x120	10	115	7	120	T40	50 pz	5 scatole
NB74674	Tassello prolungato TNAP-VTS in nylon 10x135 con vite Torx 7x140	10	135	7	140	T40	50 pz	5 scatole

TNSV - Tassello passante in nylon con vite Pozi

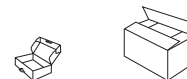
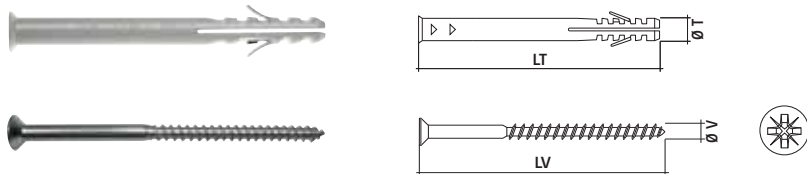

Codice	Descrizione	Ø T mm	LT mm	Ø V mm	LV mm	Impronta mm	Scatola singola	Imballo complessivo
NB7153	Tassello pass. TNSV 6x35 con vite Pozi 4,5x40	6	35	4,5	40	P2	100 pz	10 scatole
NB7160	Tassello pass. TNSV 6x50 con vite Pozi 4,5x55	6	50	4,5	55	P2	100 pz	10 scatole
NB7177	Tassello pass. TNSV 6x60 con vite Pozi 4,5x65	6	60	4,5	65	P2	100 pz	5 scatole
NB7180	Tassello pass. TNSV 6x80 con vite Pozi 4,5x85	6	80	4,5	85	P2	100 pz	5 scatole
NB7184	Tassello pass. TNSV 8x60 con vite Pozi 5,5x65	8	60	5,5	65	P3	100 pz	5 scatole
NB7191	Tassello pass. TNSV 8x80 con vite Pozi 5,5x85	8	80	5,5	85	P3	100 pz	5 scatole
NB7207	Tassello pass. TNSV 8x100 con vite Pozi 5,5x105	8	100	5,5	105	P3	50 pz	5 scatole
NB7214	Tassello pass. TNSV 8x120 con vite Pozi 5,5x125	8	120	5,5	125	P3	50 pz	5 scatole
NB7221	Tassello pass. TNSV 8x135 con vite Pozi 5,5x140	8	135	5,5	140	P3	50 pz	5 scatole
NB7245	Tassello pass. TNSV 10x80 con vite Pozi 7x85	10	80	7	85	P4	50 pz	5 scatole
NB7252	Tassello pass. TNSV 10x100 con vite Pozi 7x105	10	100	7	105	P4	50 pz	5 scatole
NB7269	Tassello pass. TNSV 10x115 con vite Pozi 7x120	10	115	7	120	P4	50 pz	5 scatole
NB7276	Tassello pass. TNSV 10x135 con vite Pozi 7x140	10	135	7	140	P4	50 pz	5 scatole
NB7283	Tassello pass. TNSV 10x160 con vite Pozi 7x165	10	160	7	165	P4	50 pz	5 scatole
NB7290	Tassello pass. TNSV 10x200 con vite Pozi 7x205	10	200	7	205	P4	50 pz	2 scatole

Installazione di infissi e serramenti



FISSAGGI PROLUNGATI PER SERRAMENTI

MATERIALI DI SUPPORTO CLS, PIETRA NATURALE, MATTONI PIENI, MATTONE CLS PIENO, MATTONI FORATI, MATTONE CLS FORATO



ABP - Tassello prolungato in nylon Ø 14 - 16

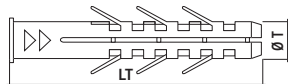

ABP 14 - 3 alette



Codice	Descrizione	Ø T mm	LT mm	Scatola singola pz	Imballo complessivo
NB53792	Tassello prolungato ABP in nylon 14x100	14	100	100 pz	2 scatole
NB8891	Tassello prolungato ABP in nylon 14x130	14	130	100 pz	2 scatole
NB53372	Tassello prolungato ABP in nylon 14x160	14	160	50 pz	2 scatole
Confezioni industriali					
NB62053	Bulk tassello prolungato ABP in nylon 14x100	14	100	-	1.600 pz
NB62060	Bulk tassello prolungato ABP in nylon 14x130	14	130	-	1.200 pz
NB62077	Bulk tassello prolungato ABP in nylon 14x160	14	160	-	900 pz

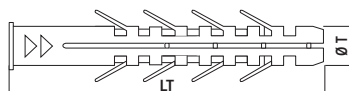

ABP 16 - 4 alette



Codice	Descrizione	Ø T mm	LT mm	Scatola singola pz	Imballo complessivo
NB8907	Tassello prolungato ABP in nylon 16x140	16	140	50 pz	2 scatole
NB8914	Tassello prolungato ABP in nylon 16x160	16	160	50 pz	2 scatole
NB8921	Tassello prolungato ABP in nylon 16x200	16	200	50 pz	2 scatole
NB8938	Tassello prolungato ABP in nylon 16x240	16	240	50 pz	2 scatole
Confezioni industriali					
NB62084	Bulk tassello prolungato ABP in nylon 16x140	16	140	-	800 pz
NB62091	Bulk tassello prolungato ABP in nylon 16x160	16	160	-	500 pz
NB62107	Bulk tassello prolungato ABP in nylon 16x200	16	200	-	500 pz
NB62114	Bulk tassello prolungato ABP in nylon 16x240	16	240	-	400 pz

ABP TR - Tassello prolungato in nylon con tirafondo DIN 571 e rondella

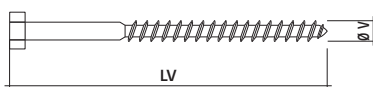
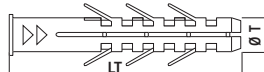

ABP 14 - 3 alette

Codice	Descrizione	Ø T mm	LT mm	Ø V mm	Ø LV mm	Impronta mm	Scatola singola pz	Imballo complessivo
NB53891	Tassello prolungato ABP TR in nylon 14x100 con tirafondo 10x100	14	100	10	100	CH17	20 pz	5 scatole
NB8785	Tassello prolungato ABP TR in nylon 14x130 con tirafondo 10x130	14	130	10	130	CH17	20 pz	5 scatole
NB53716	Tassello prolungato ABP TR in nylon 14x160 con tirafondo 10x160	14	160	10	160	CH17	20 pz	5 scatole

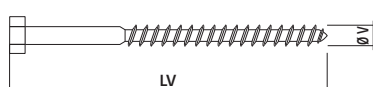
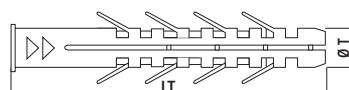

ABP 16 - 4 alette

Codice	Descrizione	Ø T mm	LT mm	Ø V mm	Ø LV mm	Impronta mm	Scatola singola pz	Imballo complessivo
NB8792	Tassello prolungato ABP TR in nylon 16x140 con tirafondo 12x140	16	140	12	140	CH19	20	5 scatole
NB8808	Tassello prolungato ABP TR in nylon 16x160 con tirafondo 12x160	16	160	12	160	CH19	20	5 scatole
NB8815	Tassello prolungato ABP TR in nylon 16x200 con tirafondo 12x200	16	200	12	200	CH19	20	5 scatole
NB8822	Tassello prolungato ABP TR in nylon 16x240 con tirafondo 12x240	16	240	12	240	CH19	20	2 scatole

ABP TRF - Tassello prolungato Ø 12 in nylon con tirafondo flangiato zincato flakes

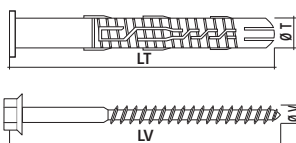

Codice	Descrizione	Ø T mm	LT mm	Ø V mm	Ø LV mm	Impronta mm	Scatola singola	Imballo complessivo
NB74160	Tassello prolungato ABP TRF 12x100 con tirafondo 8x100	12	100	8	100	CH13	25 pz	5 scatole
NB74163	Tassello prolungato ABP TRF 12x120 con tirafondo 8x120	12	120	8	120	CH13	25 pz	5 scatole
NB74166	Tassello prolungato ABP TRF 12x140 con tirafondo 8x140	12	140	8	140	CH13	25 pz	5 scatole
NB74169	Tassello prolungato ABP TRF 12x160 con tirafondo 8x160	12	160	8	160	CH13	25 pz	5 scatole
NB74172	Tassello prolungato ABP TRF 12x180 con tirafondo 8x180	12	180	8	180	CH13	25 pz	5 scatole
NB74175	Tassello prolungato ABP TRF 12x200 con tirafondo 8x200	12	200	8	200	CH13	25 pz	5 scatole

AB PROL - Tassello prolungato in nylon Ø 12

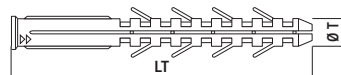

Codice	Descrizione	Ø T mm	LT mm	Scatola singola	Imballo complessivo
NB74117	Tassello prolungato AB-PROL in nylon 12x160	12	160	50 pz	5 scatole
NB44950	Tassello prolungato AB-PROL in nylon 12x200	12	200	50 pz	5 scatole
NB44967	Tassello prolungato AB-PROL in nylon 12x240	12	240	50 pz	5 scatole

Confezioni industriali



Codice	Descrizione	Ø T mm	LT mm	Scatola singola	Imballo pallet
NB74186	Bulk tassello prolungato AB-PROL in nylon 12x160	12	160	1.200 pz	16 scatole
NB74193	Bulk tassello prolungato AB-PROL in nylon 12x200	12	200	1.000 pz	16 scatole
NB74209	Bulk tassello prolungato AB-PROL in nylon 12x240	12	240	800 pz	16 scatole

ABTR - Tassello prolungato in nylon con tirafondo DIN 571 e rondella

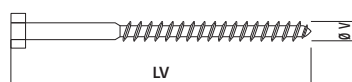

Chiave Te 17

Codice	Descrizione	Ø T mm	LT mm	Ø V mm	Ø LV mm	Scatola singola	Imballo complessivo
NB74124	Tassello prolungato ABTR in nylon 12x160 con tirafondo 10x160	12	160	10	160	20 pz	5 scatole
NB74131	Tassello prolungato ABTR in nylon 12x200 con tirafondo 10x200	12	200	10	200	20 pz	5 scatole
NB74148	Tassello prolungato ABTR in nylon 12x240 con tirafondo 10x240	12	240	10	240	20 pz	5 scatole

FISSAGGI RAPIDI IN NYLON A BATTUTA

Tassello in nylon con vite premontata rapido a battuta ad installazione controllata di tipo passante. Indicato per fissaggio di coperture, listelli in legno, infissi, telai e controtelai, profili, canaline a parete, impianti elettrici ed idraulici, pluviali, ecc



MATERIALI DI SUPPORTO CALCESTRUZZO, PIETRA NATURALE, MATTONI PIENI, MATTONE CLS PIENO, LEGNO

TNSM-RE - Tassello rapido con bordo piatto in nylon con vite zincata a battuta

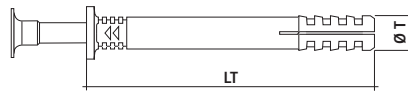

Codice	Descrizione	Ø T mm	LT mm	Scatola singola	Imballo complessivo
NB8983	Tassello rapido TNSM-RE in nylon 5x30 con vite zincata	5	30	200 pz	10 scatole
NB29827	Tassello rapido TNSM-RE in nylon 5x40 con vite zincata	5	40	100 pz	10 scatole
NB8990	Tassello rapido TNSM-RE in nylon 5x50 con vite zincata	5	50	100 pz	10 scatole
NB9003	Tassello rapido TNSM-RE in nylon 6x35 con vite zincata	6	35	100 pz	10 scatole
NB9010	Tassello rapido TNSM-RE in nylon 6x40 con vite zincata	6	40	100 pz	10 scatole
NB89647	Tassello rapido TNSM-RE in nylon 6x50 con vite zincata	6	50	100 pz	10 scatole
NB9027	Tassello rapido TNSM-RE in nylon 6x60 con vite zincata	6	60	100 pz	5 scatole
NB9041	Tassello rapido TNSM-RE in nylon 6x80 con vite zincata	6	80	100 pz	5 scatole
NB9065	Tassello rapido TNSM-RE in nylon 8x60 con vite zincata	8	60	100 pz	5 scatole
NB9072	Tassello rapido TNSM-RE in nylon 8x80 con vite zincata	8	80	100 pz	5 scatole
NB9089	Tassello rapido TNSM-RE in nylon 8x100 con vite zincata	8	100	100 pz	5 scatole
NB9096	Tassello rapido TNSM-RE in nylon 8x120 con vite zincata	8	120	100 pz	5 scatole
NB9102	Tassello rapido TNSM-RE in nylon 8x140 con vite zincata	8	140	100 pz	5 scatole

Confezioni industriali

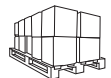

Codice	Descrizione	Ø T mm	LT mm	Scatola singola	Imballo pallet complessivo
NB48736	Bulk tassello rapido TNSM-RE 5x30 con vite zincata	5	30	4.000 pz	-
NB48743	Bulk tassello rapido TNSM-RE 5x40 con vite zincata	5	40	4.000 pz	-
NB48750	Bulk tassello rapido TNSM-RE 5x50 con vite zincata	5	50	3.000 pz	-
NB48767	Bulk tassello rapido TNSM-RE 6x35 con vite zincata	6	35	2.000 pz	-
NB48774	Bulk tassello rapido TNSM-RE 6x40 con vite zincata	6	40	4.500 pz	-
NB89654	Bulk tassello rapido TNSM-RE 6x50 con vite zincata	6	50	2.400 pz	-
NB48781	Bulk tassello rapido TNSM-RE 6x60 con vite zincata	6	60	1.500 pz	-
NB48804	Bulk tassello rapido TNSM-RE 6x80 con vite zincata	6	80	1.500 pz	-
NB48828	Bulk tassello rapido TNSM-RE 8x60 con vite zincata	8	60	1.000 pz	-
NB48835	Bulk tassello rapido TNSM-RE 8x80 con vite zincata	8	80	800 pz	-
NB48842	Bulk tassello rapido TNSM-RE 8x100 con vite zincata	8	100	700 pz	-
NB48859	Bulk tassello rapido TNSM-RE 8x120 con vite zincata	8	120	700 pz	-
NB48866	Bulk tassello rapido TNSM-RE 8x140 con vite zincata	8	140	500 pz	-

FISSAGGI RAPIDI IN NYLON A BATTUTA

TNSM-SV - Tassello rapido con bordo svasato in nylon vite zincata a battuta

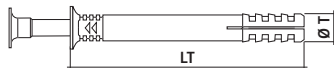

Codice	Descrizione	Ø T mm	LT mm	Scatola singola	Imballo complessivo
NB9119	Tassello rapido TNSM-SV con bordo svasato in nylon 5x25 con vite zincata	5	25	200 pz	10 scatole
NB9126	Tassello rapido TNSM-SV con bordo svasato in nylon 5x30 con vite zincata	5	30	100 pz	10 scatole
NB29834	Tassello rapido TNSM-SV con bordo svasato in nylon 5x40 con vite zincata	5	40	100 pz	10 scatole
NB9133	Tassello rapido TNSM-SV con bordo svasato in nylon 5x50 con vite zincata	5	50	100 pz	10 scatole
NB9140	Tassello rapido TNSM-SV con bordo svasato in nylon 6x35 con vite zincata	6	35	100 pz	10 scatole
NB9157	Tassello rapido TNSM-SV con bordo svasato in nylon 6x40 con vite zincata	6	40	100 pz	10 scatole
NB89661	Tassello rapido TNSM-SV con bordo svasato in nylon 6x50 con vite zincata	6	50	100 pz	10 scatole
NB9164	Tassello rapido TNSM-SV con bordo svasato in nylon 6x60 con vite zincata	6	60	100 pz	5 scatole
NB9188	Tassello rapido TNSM-SV con bordo svasato in nylon 6x80 con vite zincata	6	80	100 pz	5 scatole
NB9190	Tassello rapido TNSM-SV con bordo svasato in nylon 6x100 con vite zincata	6	100	100 pz	5 scatole
NB9201	Tassello rapido TNSM-SV con bordo svasato in nylon 8x60 con vite zincata	8	60	100 pz	5 scatole
NB9218	Tassello rapido TNSM-SV con bordo svasato in nylon 8x80 con vite zincata	8	80	100 pz	5 scatole
NB9225	Tassello rapido TNSM-SV con bordo svasato in nylon 8x100 con vite zincata	8	100	100 pz	5 scatole
NB9232	Tassello rapido TNSM-SV con bordo svasato in nylon 8x120 con vite zincata	8	120	100 pz	5 scatole
NB9249	Tassello rapido TNSM-SV con bordo svasato in nylon 8x140 con vite zincata	8	140	100 pz	5 scatole
NB9251	Tassello rapido TNSM-SV con bordo svasato in nylon 8x160 con vite zincata	8	160	100 pz	5 scatole
NB9254	Tassello rapido TNSM-SV con bordo svasato in nylon 8x195 con vite zincata	8	195	100 pz	5 scatole

Confezioni industriali



Codice	Descrizione	Ø T mm	LT mm	Scatola singola	Imballo pallet
NB48873	Bulk tassello TNSM-SV rapido con bordo svasato in nylon 5x30 con vite zincata	5	30	4.000 pz	-
NB48880	Bulk tassello TNSM-SV rapido con bordo svasato in nylon 5x40 con vite zincata	5	40	4.000 pz	-
NB48897	Bulk tassello TNSM-SV rapido con bordo svasato in nylon 5x50 con vite zincata	5	50	3.000 pz	-
NB48903	Bulk tassello TNSM-SV rapido con bordo svasato in nylon 6x35 con vite zincata	6	35	2.000 pz	-
NB48910	Bulk tassello TNSM-SV rapido con bordo svasato in nylon 6x40 con vite zincata	6	40	4.500 pz	-
NB89678	Bulk tassello TNSM-SV rapido con bordo svasato in nylon 6x50 con vite zincata	6	50	2.000 pz	-
NB48927	Bulk tassello TNSM-SV rapido con bordo svasato in nylon 6x60 con vite zincata	6	60	1.500 pz	-
NB48941	Bulk tassello TNSM-SV rapido con bordo svasato in nylon 6x80 con vite zincata	6	80	1.500 pz	-
NB48965	Bulk tassello TNSM-SV rapido con bordo svasato in nylon 8x60 con vite zincata	8	60	1.000 pz	-
NB48972	Bulk tassello TNSM-SV rapido con bordo svasato in nylon 8x80 con vite zincata	8	80	800 pz	-
NB48989	Bulk tassello TNSM-SV rapido con bordo svasato in nylon 8x100 con vite zincata	8	100	700 pz	-
NB48996	Bulk tassello TNSM-SV rapido con bordo svasato in nylon 8x120 con vite zincata	8	120	450 pz	-
NB49009	Bulk tassello TNSM-SV rapido con bordo svasato in nylon 8x140 con vite zincata	8	140	500 pz	-



Disponibile in blister



Disponibile in secchiello

FISSAGGI RAPIDI IN NYLON A BATTUTA

Tassello in nylon con vite premontata in Inox A2 a battuta, ad installazione controllata di tipo passante. Indicato per fissaggio di coperture, listelli in legno, infissi, telai e controtelai, profili, canaline a parete, impianti elettrici ed idraulici, pluviali, ecc



MATERIALI DI SUPPORTO CALCESTRUZZO, PIETRA NATURALE, MATTONI PIENI, MATTONE CLS PIENO, LEGNO

TNSMX-RE - Tassello rapido con bordo retto in nylon con vite inox A2 a battuta

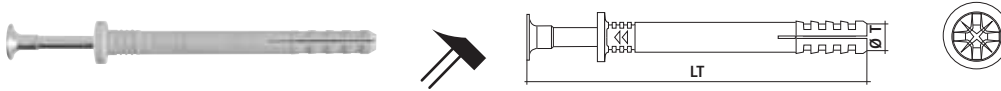

Codice	Descrizione	Ø T mm	LT mm	Scatola singola	Imballo complessivo
NB66853	Tassello rapido TNSMX-RE in nylon 6x35 con bordo piatto e vite inox A2	6	35	100 pz	10 scatole
NB60929	Tassello rapido TNSMX-RE in nylon 6x40 con bordo piatto e vite inox A2	6	40	100 pz	10 scatole
NB60943	Tassello rapido TNSMX-RE in nylon 6x60 con bordo piatto e vite inox A2	6	60	100 pz	5 scatole
NB66860	Tassello rapido TNSMX-RE in nylon 6x80 con bordo piatto e vite inox A2	6	80	100 pz	5 scatole
NB66877	Tassello rapido TNSMX-RE in nylon 8x60 con bordo piatto e vite inox A2	8	60	100 pz	5 scatole
NB66884	Tassello rapido TNSMX-RE in nylon 8x80 con bordo piatto e vite inox A2	8	80	100 pz	5 scatole
NB66891	Tassello rapido TNSMX-RE in nylon 8x100 con bordo piatto e vite inox A2	8	100	100 pz	5 scatole

TNSMX-SV - Tassello rapido con bordo svasato in nylon con vite inox A2 a battuta

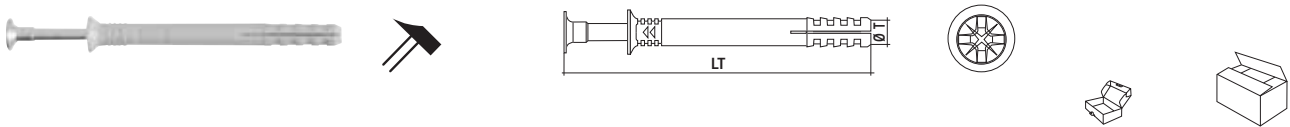

Codice	Descrizione	Ø T mm	LT mm	Scatola singola	Imballo complessivo
NB66907	Tassello rapido TNSMX-SV con bordo retto in nylon 6x35 con vite inox A2	6	35	100 pz	10 scatole
NB60950	Tassello rapido TNSMX-SV con bordo retto in nylon 6x40 con vite inox A2	6	40	100 pz	10 scatole
NB60974	Tassello rapido TNSMX-SV con bordo retto in nylon 6x60 con vite inox A2	6	60	100 pz	5 scatole
NB66914	Tassello rapido TNSMX-SV con bordo retto in nylon 6x80 con vite inox A2	6	80	100 pz	5 scatole
NB66921	Tassello rapido TNSMX-SV con bordo retto in nylon 8x60 con vite inox A2	8	60	100 pz	5 scatole
NB66938	Tassello rapido TNSMX-SV con bordo retto in nylon 8x80 con vite inox A2	8	80	100 pz	5 scatole
NB66945	Tassello rapido TNSMX-SV con bordo retto in nylon 8x100 con vite inox A2	8	100	100 pz	5 scatole



◀ Installazione tende e listelli in legno

FISSAGGI RAPIDI IN NYLON A BATTUTA

TNA-FIL - Tassello in nylon con vite a doppio filetto

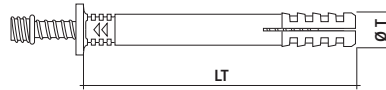

Codice	Descrizione	Ø T mm	LT mm	Busta singola	Imballo complessivo
NB9546	Tassello passante TNA-FIL in nylon 6x35 con vite doppio filetto	6	35	100 pz	10 scatole
NB9553	Tassello passante TNA-FIL in nylon 8x60 con vite doppio filetto	8	60	50 pz	10 scatole

Idoneo per collari CL (v. pag. 109).

TNB - Tassello passante in nylon a testa bombata con vite a battuta

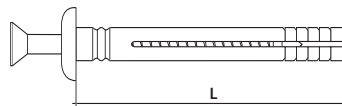

Codice	Descrizione	Ø T mm	LT mm	Scatola singola	Imballo complessivo
NB9294	Tassello TNB in nylon 5x25 con vite a battuta	5	25	100 pz	10 scatole
NB9300	Tassello TNB in nylon 6x25 con vite a battuta	6	25	100 pz	10 scatole
NB9317	Tassello TNB in nylon 6x40 con vite a battuta	6	40	100 pz	10 scatole
NB9324	Tassello TNB in nylon 6x50 con vite a battuta	6	50	100 pz	5 scatole
NB9331	Tassello TNB in nylon 6x60 con vite a battuta	6	60	100 pz	5 scatole
NB71499	Tassello TNB in nylon 6x80 con vite a battuta	6	80	100 pz	5 scatole

TNB-VTX - Tassello passante in nylon con vite in acciaio inox A2

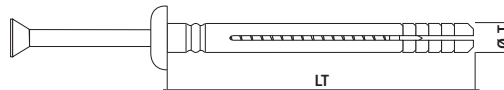

Codice	Descrizione	Ø T mm	LT mm	Scatola singola	Imballo complessivo
NB49276	Tassello TNB-VTX in nylon 6/40 con vite inox A2	6	40	100 pz	10 scatole
NB63241	Tassello TNB-VTX in nylon 6/50 con vite inox A2	6	50	100 pz	5 scatole
NB49283	Tassello TNB-VTX in nylon 6/60 con vite inox A2	6	60	100 pz	5 scatole

FISSAGGI RAPIDI IN NYLON A BATTUTA

MATERIALI DI SUPPORTO CALCESTRUZZO, PIETRA NATURALE, MATTONI PIENI, MATTONE CLS PIENO



TNB-RX - Tassello con vite testa bombata inox e guarnizione neoprene per lattoneria

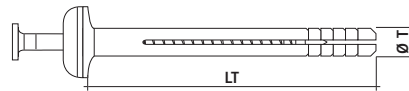

Codice	Descrizione	Ø T mm	LT mm	Scatola singola	Imballo complessivo
NB63487	Tassello passante TNB-RX 6x40 con battuta a martello e borchia inox	6	40	100 pz	10 scatole
NB63494	Tassello passante TNB-RX 6x50 con battuta a martello e borchia inox	6	50	100 pz	5 scatole
NB63500	Tassello passante TNB-RX 6x60 con battuta a martello e borchia inox	6	60	100 pz	5 scatole

TNB-RR - Tassello con vite testa bombata rame e guarnizione neoprene per lattoneria

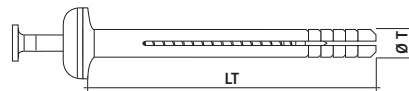

Codice	Descrizione	Ø T mm	LT mm	Busta singola	Imballo complessivo
NB63517	Tassello passante TNB-RR 6x40 con battuta a martello e borchia rame	6	40	100 pz	10 scatole
NB63524	Tassello passante TNB-RR 6x50 con battuta a martello e borchia rame	6	50	100 pz	5 scatole
NB63531	Tassello passante TNB-RR 6x60 con battuta a martello e borchia rame	6	60	100 pz	5 scatole

TNB-TRL - Tassello con vite ramata testa larga per lattoneria a battuta

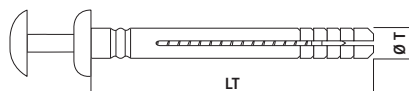

Codice	Descrizione	Ø T mm	LT mm	Scatola singola	Imballo complessivo
NB9539	Tassello passante TNB-TRL con vite ramata testa larga 6x40 per lattoneria	6	40	100 pz	5 scatole

FISSAGGI RAPIDI IN NYLON E ZAMAK A BATTUTA

TNB-TM - Tassello con vite nera battuta

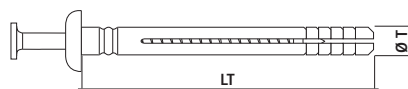

Codice	Descrizione	Ø T mm	LT mm	Scatola singola	Imballo complessivo
NB9478	Tassello passante con vite nera TNB-TM 6x40	6	40	100 pz	10 scatole
NB9485	Tassello passante con vite nera TNB-TM 6x50	6	50	100 pz	5 scatole
NB9492	Tassello passante con vite nera TNB-TM 6x60	6	60	100 pz	5 scatole

TNB-TMR - Tassello con vite zincata e ramata

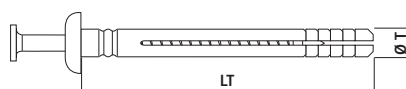

Codice	Descrizione	Ø T mm	LT mm	Scatola singola	Imballo complessivo
NB9508	Tassello passante con vite ramata TNB-TMR 6x40	6	40	100 pz	10 scatole
NB9515	Tassello passante con vite ramata TNB-TMR 6x50	6	50	100 pz	5 scatole
NB9522	Tassello passante con vite ramata TNB-TMR 6x60	6	60	100 pz	5 scatole

TZB - Tassello in zamak con chiodo in acciaio indicato per coperture (ad esaurimento)

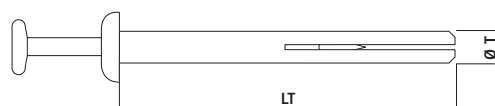

Codice	Descrizione	Ø T mm	LT mm	Scatola singola	Imballo complessivo
NB29841	Tassello passante TZB 6x30 con chiodo in acciaio speciale per guide cartongesso	6	30	100 pz	10 scatole
NB9263	Tassello passante TZB 6x40 con chiodo in acciaio speciale per guide cartongesso	6	40	100 pz	10 scatole
NB9270	Tassello passante TZB 6x50 con chiodo in acciaio speciale per guide cartongesso	6	50	100 pz	5 scatole
NB9287	Tassello passante TZB 6x60 con chiodo in acciaio speciale per guide cartongesso	6	60	100 pz	5 scatole

FISSAGGI PER ISOLAMENTO

FISSAGGI PER ISOLAMENTO

ISO	92
ISO L	92
ISO-P	92
ISO-S CE	93
RP-I	94
RP-T	94
ISO-ST	95
ISO-ECO	95
N-PL	96
ISO-D	96

FISSAGGI RAPIDI A BATTUTA ETICS PER ISOLAMENTO

Tassello in polipropilene bianco con chiodo percussore, in poliammide o acciaio rinforzato con fibra di vetro, di tipo passante a battuta. Idoneo per il fissaggio di materiali isolanti sia rigidi sia morbidi su materiali compatti e semicompatti come polisterene, polistirolo, lana di vetro, lana di rocca, etc.

MATERIALI DI SUPPORTO CALCESTRUZZO, PIETRA NATURALE, MATTONI PIENI, MATTONE CLS PIENO

ISO - Tassello rapido per pannelli rigidi ETAG 014

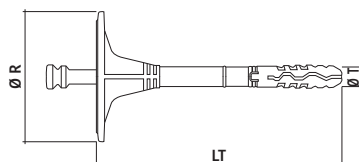

Cert. Cat. A-B-C

Codice	Descrizione	Ø T mm	Ø R mm	LT mm	Scatola singola	Imballo complessivo
NB8945	Tassello rapido per pannelli rigidi ISO 10x50x70	10	50	70	250 pz	-
NB8952	Tassello rapido per pannelli rigidi ISO 10x50x90	10	50	90	250 pz	-
NB8969	Tassello rapido per pannelli rigidi ISO 10x50x110	10	50	110	250 pz	-
NB29803	Tassello rapido per pannelli rigidi ISO 10x50x130	10	50	130	250 pz	-
NB29810	Tassello rapido per pannelli rigidi ISO 10x50x150	10	50	150	250 pz	-
NB8976	Tassello rapido per pannelli rigidi ISO 10x50x180	10	50	180	250 pz	-
NB8980	Tassello rapido per pannelli rigidi ISO 10x50x210	10	50	210	250 pz	-
NB8985	Tassello rapido per pannelli rigidi ISO 10x50x240	10	50	240	250 pz	-

ISO-L - Tassello rapido etics per pannelli isolanti morbidi

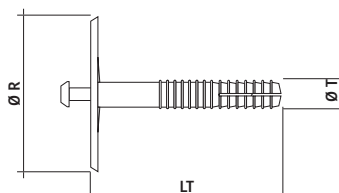

Codice	Descrizione	Ø T mm	Ø R mm	LT mm	Scatola singola	Imballo complessivo
NB9621	Tassello ISO-L rapido per pannelli morbidi 10x90x60 perno in poliammide	10	90	60	400 pz	-
NB9645	Tassello ISO-L rapido per pannelli morbidi 10x90x110 perno in poliammide	10	90	110	200 pz	-

ISO-P - Tasselli in polipropilene per pannelli isolanti rigidi

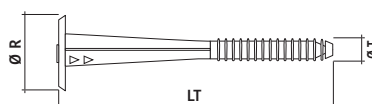

Codice	Descrizione	Ø R mm	Ø T mm	LT mm	Scatola singola	Imballo complessivo
NB9585	Tasselli rapidi in nylon ISO-P 40/70	40	8	70	-	1000 pz
NB9591	Tasselli rapidi in nylon ISO-P 40/90	40	8	90	-	1000 pz
NB9614	Tasselli rapidi in nylon ISO-P 40/110	40	8	110	-	1000 pz
NB9620	Tasselli rapidi in nylon ISO-P 40/130	40	8	130	-	1000 pz

FISSAGGI RAPIDI A BATTUTA ETICS PER ISOLAMENTO

ISO-S CE - Tassello con chiodo in nylon per fissaggi su supporto compatto ETAG 014

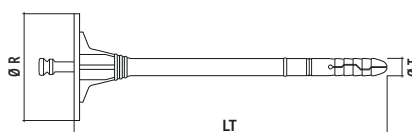

Cert. Cat. A-B-C-D-E

Codice	Descrizione	Ø T mm	Ø R mm	LT mm	Scatola singola	Imballo complessivo
NB88850	Tassello con chiodo in nylon per supporto compatto ISO-S CE 8X95	8	60	95	200 pz	-
NB88851	Tassello con chiodo in nylon per supporto compatto ISO-S CE 8X115	8	60	115	200 pz	-
NB88852	Tassello con chiodo in nylon per supporto compatto ISO-S CE 8X135	8	60	135	200 pz	-
NB88853	Tassello con chiodo in nylon per supporto compatto ISO-S CE 8X155	8	60	155	200 pz	-
NB88854	Tassello con chiodo in nylon per supporto compatto ISO-S CE 8X175	8	60	175	200 pz	-
NB88855	Tassello con chiodo in nylon per supporto compatto ISO-S CE 8X195	8	60	195	200 pz	-
NB88980	Tassello con chiodo in nylon per supporto compatto ISO-S CE 10x70	10	60	70	200 pz	-
NB88982	Tassello con chiodo in nylon per supporto compatto ISO-S CE 10x90	10	60	90	200 pz	-
NB88984	Tassello con chiodo in nylon per supporto compatto ISO-S CE 10x110	10	60	110	200 pz	-
NB88986	Tassello con chiodo in nylon per supporto compatto ISO-S CE 10x120	10	60	120	200 pz	-
NB88988	Tassello con chiodo in nylon per supporto compatto ISO-S CE 10x140	10	60	140	200 pz	-
NB88990	Tassello con chiodo in nylon per supporto compatto ISO-S CE 10x160	10	60	160	200 pz	-
NB88991	Tassello con chiodo in nylon per supporto compatto ISO-S CE 10x180	10	60	180	200 pz	-
NB88994	Tassello con chiodo in nylon per supporto compatto ISO-S CE 10x200	10	60	200	200 pz	-
NB88996	Tassello con chiodo in nylon per supporto compatto ISO-S CE 10x220	10	60	220	100 pz	-
NB88998	Tassello con chiodo in nylon per supporto compatto ISO-S CE 10x260	10	60	260	100 pz	-

ISO-S CE - Tassello con chiodo in acciaio per supporti compatti ETAG 014

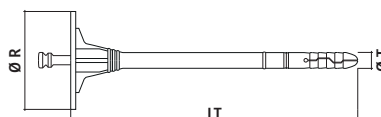

Cert. Cat. A-B-C-D-E

Codice	Descrizione	Ø T mm	Ø R mm	LT mm	Scatola singola	Imballo complessivo
NB88960	Tassello con chiodo in acciaio per supporto compatto ISO-S CE 8x95	8	60	95	200 pz	-
NB88962	Tassello con chiodo in acciaio per supporto compatto ISO-S CE 8x115	8	60	115	200 pz	-
NB88964	Tassello con chiodo in acciaio per supporto compatto ISO-S CE 8x135	8	60	135	200 pz	-
NB88966	Tassello con chiodo in acciaio per supporto compatto ISO-S CE 8x155	8	60	155	200 pz	-
NB88968	Tassello con chiodo in acciaio per supporto compatto ISO-S CE 8x175	8	60	175	200 pz	-
NB88970	Tassello con chiodo in acciaio per supporto compatto ISO-S CE 8x195	8	60	195	200 pz	-
NB88881	Tassello con chiodo in acciaio per supporto compatto ISO-S CE 10X70	10	60	70	200 pz	-
NB88882	Tassello con chiodo in acciaio per supporto compatto ISO-S CE 10X90	10	60	90	200 pz	-
NB88883	Tassello con chiodo in acciaio per supporto compatto ISO-S CE 10X110	10	60	110	200 pz	-
NB88884	Tassello con chiodo in acciaio per supporto compatto ISO-S CE 10X120	10	60	120	200 pz	-
NB88885	Tassello con chiodo in acciaio per supporto compatto ISO-S CE 10X140	10	60	140	200 pz	-
NB88886	Tassello con chiodo in acciaio per supporto compatto ISO-S CE 10X160	10	60	160	200 pz	-
NB88887	Tassello con chiodo in acciaio per supporto compatto ISO-S CEE 10X180	10	60	180	200 pz	-
NB88888	Tassello con chiodo in acciaio per supporto compatto ISO-S CE 10X200	10	60	200	200 pz	-
NB88889	Tassello con chiodo in acciaio per supporto compatto ISO-S CE 10X220	10	60	220	200 pz	-
NB88890	Tassello con chiodo in acciaio per supporto compatto ISO-S CE 10X260	10	60	260	200 pz	-

RONDELLE ETICS PER ISOLAMENTO

MATERIALI DI SUPPORTO MATERIALI ISOLANTI

RP-I - Rondella in nylon rinforzata fibra di vetro per fissaggio sistema Etics

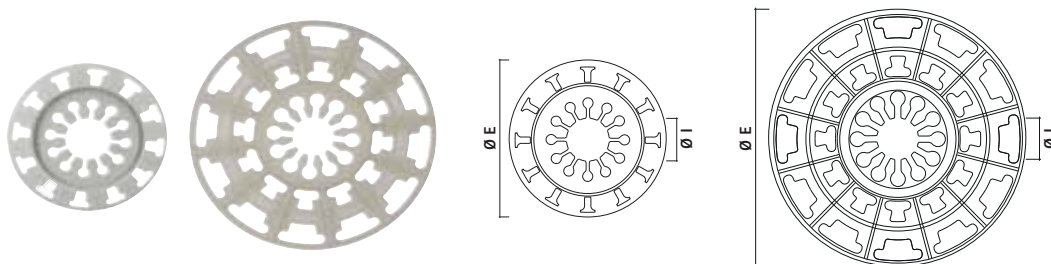

Codice	Descrizione	Ø I mm	Ø E Tmm	Scatola singola	Imballo complessivo
NB9653	Rondella RP-I in nylon rinforzata fibra di vetro 10x90	10	90	500 pz	-
NB9654	Rondella RP-I in nylon rinforzata fibra di vetro 10x140	10	140	500 pz	-

Indicata per applicazione abbinata a tassello per cappotto ISO S

RP-T - Rondella in nylon rinforzata fibra di vetro, con tappo per fissaggio sistema Etics



Codice	Descrizione	Ø E mm	Ø I mm	Ø V mm	Scatola singola	Imballo complessivo
NB9600	Rondella RP-T in nylon rinforzata fibra di vetro 12x60	60	12	8	500 pz	-

Indicata per applicazione abbinata a tassello per cappotto ISO S

FISSAGGI A VITE ETICS PER ISOLAMENTO

MATERIALI DI SUPPORTO CALCESTRUZZO, PIETRA NATURALE, MATTONI PIENI, MATTONE FORATO, MATTONE CLS PIENO, MATERIALI ISOLANTI

ISO-ST - Tasselli in polipropilene additivato con chiodo a vite per pannelli rigidi

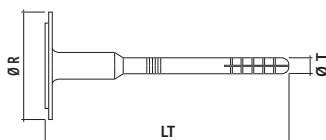

Codice	Descrizione	Ø T mm	Ø R mm	LT mm	Scatola singola	Imballo complessivo
NB112800	Tasselli con perno ISO-ST in acciaio e polipropilene 8X95	8	60	95	200 pz	-
NB112801	Tasselli con perno ISO-ST in acciaio e polipropilene 8X115	8	60	115	200 pz	-
NB112802	Tasselli con perno ISO-ST in acciaio e polipropilene 8X135	8	60	135	200 pz	-
NB112803	Tasselli con perno ISO-ST in acciaio e polipropilene 8X155	8	60	155	200 pz	-
NB112804	Tasselli con perno ISO-ST in acciaio e polipropilene 8X175	8	60	175	200 pz	-
NB112805	Tasselli con perno ISO-ST in acciaio e polipropilene 8X195	8	60	195	200 pz	-
NB112806	Tasselli con perno ISO-ST in acciaio e polipropilene 8X215	8	60	215	200 pz	-
NB112807	Tasselli con perno ISO-ST in acciaio e polipropilene 8X235	8	60	235	200 pz	-
NB112808	Tasselli con perno ISO-ST in acciaio e polipropilene 8X255	8	60	255	200 pz	-
NB112809	Tasselli con perno ISO-ST in acciaio e polipropilene 8X275	8	60	275	200 pz	-
NB112810	Tasselli con perno ISO-ST in acciaio e polipropilene 8X295	8	60	295	200 pz	-

ISO-ECO - Tassello in poliammide rinforzato fibra di vetro con vite in acciaio Torx

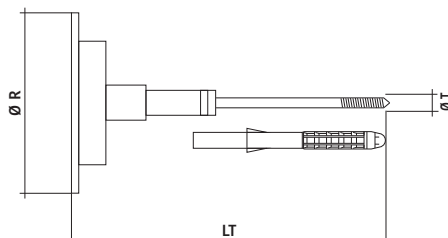

Idoneo per legno e fibramento

Codice	Descrizione	Ø R mm	Ø T mm	LT mm	Scatola singola	Imballo complessivo
NB88715	Tassello ISO-ECO in poliammide rinforzato con vite Torx 8X150	110	8	150	50 pz	-
NB88717	Tassello ISO-ECO in poliammide rinforzato con vite Torx 8X170	110	8	170	50 pz	-
NB88719	Tassello ISO-ECO in poliammide rinforzato con vite Torx 8X190	110	8	190	50 pz	-
NB88721	Tassello ISO-ECO in poliammide rinforzato con vite Torx 8X210	110	8	210	50 pz	-
NB88723	Tassello ISO-ECO in poliammide rinforzato con vite Torx 8X230	110	8	230	50 pz	-
NB88726	Tassello ISO-ECO in poliammide rinforzato con vite Torx 8X250	110	8	250	50 pz	-
NB88727	Tassello ISO-ECO in poliammide rinforzato con vite Torx 8X270	110	8	270	50 pz	-
NB88729	Tassello ISO-ECO in poliammide rinforzato con vite Torx 8X290	110	8	290	50 pz	-
NB88731	Tassello ISO-ECO in poliammide rinforzato con vite Torx 8X310	110	8	310	50 pz	-
NB88733	Tassello ISO-ECO in poliammide rinforzato con vite Torx 8X330	110	8	330	50 pz	-
NB88735	Tassello ISO-ECO in poliammide rinforzato con vite Torx 8X350	110	8	350	50 pz	-
NB88737	Tassello ISO-ECO in poliammide rinforzato con vite Torx 8X370	110	8	370	50 pz	-
NB88739	Tassello ISO-ECO in poliammide rinforzato con vite Torx 8X390	110	8	390	50 pz	-
NB88741	Tassello ISO-ECO in poliammide rinforzato con vite Torx 8X410	110	8	410	50 pz	-
NB88743	Tassello ISO-ECO in poliammide rinforzato con vite Torx 8X430	110	8	430	50 pz	-

ACCESSORI ETICS PER ISOLAMENTO
MATERIALI DI SUPPORTO MATERIALI ISOLANTI, LEGNO E FIBRA CEMENTO

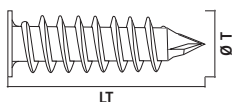
N-PL - Tasselli in nylon per fissaggio su cappotti

Codice	Descrizione	Ø T mm	LT mm	Scatola singola	Imballo complessivo
NB9656	Tasselli N-PL in nylon per fissaggio su cappotti 50	25	50	25 pz	10 scatole
NB9660	Tasselli N-PL in nylon per fissaggio su cappotti 60 con inserto Torx 40	25	60	25 pz	10 scatole
NB9695	Tasselli N-PL in nylon per fissaggio su cappotti 95	25	95	20 pz	5 scatole

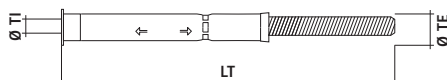
ISO-D - Sistema di fissaggio a taglio termico per fissaggi distanziati

Codice	Descrizione	Ø TE mm	Ø TI M	LT mm	Scatola singola	Imballo complessivo
NB112890	Sistema di fissaggio a taglio termico ISO-D M6 16X215	16	6	215	12 pz	-
NB112891	Sistema di fissaggio a taglio termico IOS-D M6 16X260	16	6	260	12 pz	-
NB112892	Sistema di fissaggio a taglio termico ISO-D M8 16X215	16	8	210	12 pz	-
NB112893	Sistema di fissaggio a taglio termico ISO-D M8 16X260	16	8	260	12 pz	-
NB112894	Sistema di fissaggio a taglio termico ISO-D M 10 20X240	20	10	240	12 pz	-
NB112895	Sistema di fissaggio a taglio termico ISO-D M10 20X285	20	10	285	12 pz	-
NB112896	Sistema di fissaggio a taglio termico ISO-D M12 20X240	20	12	240	12 pz	-
NB112897	Sistema di fissaggio a taglio termico ISO-D M12 20X285	20	12	285	12 pz	-
NB112898	Sistema di fissaggio a taglio termico ISO-D RETINA M6/M8	-	6/8	-	12 pz	-
NB112899	Sistema di fissaggio a taglio termico ISO-D RETINA M10/M12	-	10/12	-	12 pz	-



▲ Installazione di cappotto termico e sistemi di isolamento



▲ Installazione di ferma imposte e illuminazioni, su pareti con cappotto termico

FISSAGGI IDRO TERMO SANITARI

FISSAGGI IDRO TERMO SANITARI

WC	100	CHP	115
WC 2	100	BTS	115
FL	101	BP	115
NNB-FL	101	FSC	116-118
FCS	101	VTN	118
NNB-GC	102	BSF	119
SXLV-GL	102	TUBE-FIX	119
NCV-TE	102	GRAP-FIX	119-120
CF-KIT	103	CLIP-FIX	120
CF	103	NFA	120
CF-PVC	104	NCF	121
CFC-PVC	104	FBP W1-W2-W4	122-124
CFX A2	105	FM MT	125
CFX-CA2	105	FBP-MT	125
CF-ISO	106	FBP-CF C7	125
CP	106	RPZ	126
CP-TMRO	107	ROND	126
CP-RA	107	RQ-1	126
CP-X	107	B-FIL	127
CF-RX	108	BAR-F	127
CL-R	108	DM-DA	128
CL-R BAG	109	VITE TSP	129-130
CL	109	TRF	131
CL-V	110	W/RW	132
CV	111	AUT-LA/PERF-LA	133
CVD	111	GUA-RC/ROND	134
CVP	112	BR	135
CAV	112	VFX	135
VCG	113	BR-AP	135
VCG-A	113	ROND-C	136
VIS	114	CPL	137
VIS-AB	114	ROND-PVC	137
VIS-NC	114	ROND-PL	137
CH	115		

FISSAGGI PER IDRO-TERMO-SANITARI

Sistemi di fissaggio per sanitari e scaldabagno.

MATERIALI DI SUPPORTO CALCESTRUZZO, PIETRA NATURALE, MATTONI PIENI, MATTONE FORATO

WC - Tasselli in nylon per vasi e bidet con vite in ottone TE

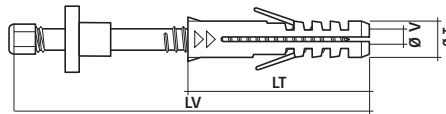

Codice	Descrizione	Ø T mm	LT mm	Ø V mm	LV mm	Ø V mm	Busta singola	Imballo complessivo
NB10283	Tassello in nylon WC 10x50 con vite TE 6x80 in ottone	10	50	6	80	10	4 pz	50 buste
NB10285	Tassello in nylon WC 10x50 con vite TE 6x90 in ottone	10	50	6	90	10	4 pz	50 buste
NB73486	Tassello in nylon WC 8x40 con vite TE 6x80 in ottone	8	40	6	80	8	4 pz	50 buste
NB10306	Tassello in nylon WC10x50 con vite TE 6x80 in ottone	10	50	6	80	10	4 pz	50 buste
NB10290	Tassello in nylon WC 10x50 con vite TE 6x80 in ottone	10	50	6	80	10	4 pz	50 buste



Disponibile in blister



Disponibile in blister 4 pz

WC 2 - Staffe a L in nylon per fissaggio laterale di vasi e bidet complete di tassello AB con vite TEF e vite copricalotta

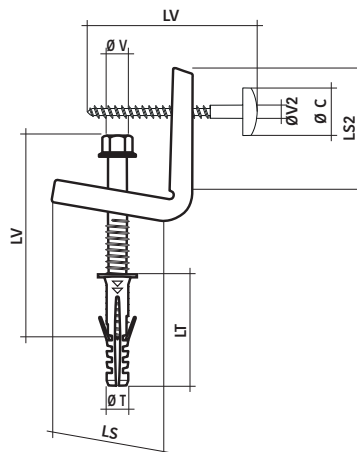

Codice	Descrizione	Ø T mm	LT mm	Ø V mm	LV mm	Ø V2 mm	Ø C mm	LV2 mm	LS mm	LS2 mm	Busta singola	Imballo complessivo
NB10313	Staffa a L in nylon per fissaggio WC 2 con tassello AB, vite TEF e vite copricalotta	10	60	6	65	5	20	80	42	52	2 pz	25 buste



Disponibile in blister 4 pz

FISSAGGI PER IDRO-TERMO-SANITARI

FL - Staffe per fissaggio di lavabi e cassette con vite doppio filetto e dado

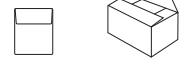
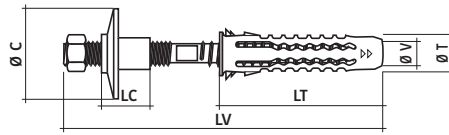

Codice	Descrizione	Ø T mm	LT mm	Ø V mm	LV mm	Ø C mm	LC mm	Busta singola	Imballo complessivo
NB9690	Staffe FL 8x90 con vite doppio filetto e dado	10	60	8	90	35	17	2 pz	50 buste
NB9706	Staffe FL 8x100 con vite doppio filetto e dado	10	50	8	100	35	17	2 pz	50 buste
NB9713	Staffe FL 10x100 con vite doppio filetto e dado	12	60	10	100	35	17	2 pz	50 buste
NB9720	Staffe FL 10x120 con vite doppio filetto e dado	12	60	10	120	35	17	2 pz	50 buste

Disponibile in blister 2 pz

NNB-FL - Staffe per fissaggio di lavabi e cassette con doppio filetto

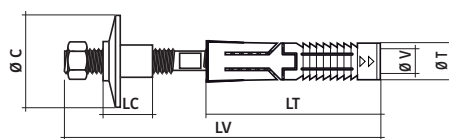

Codice	Descrizione	Ø T mm	LT mm	Ø V mm	LV mm	Ø C mm	LC mm	Busta singola	Imballo complessivo
NB9630	Staffe NNB-FL 10x145 con vite doppio filetto	14	70	10	145	35	17	2 pz	50 buste

Disponibile in blister 2 pz

FCS - Tasselli in nylon con codetta per fissaggio scaldabagni

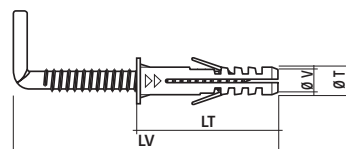

Codice	Descrizione	Ø T mm	LT mm	Ø V mm	LV mm	Busta singola	Imballo complessivo
NB9812	Tassello in nylon FCS 10x60 con codetta 8x70	10	60	8	70	2 pz	50 buste
NB9829	Tassello in nylon FCS 12x60 con codetta 10x80	12	60	10	80	2 pz	50 buste
NB9836	Tassello in nylon FCS 12x60 con codetta 10x95	12	60	10	95	2 pz	50 buste
NB9843	Tassello in nylon FCS 14x80 con codetta 10x120	14	80	10	120	2 pz	50 buste

Disponibile in blister

Disponibile in blister 4 pz

FISSAGGI PER IDRO-TERMO-SANITARI

MATERIALI DI SUPPORTO CALCESTRUZZO, PIETRA NATURALE, MATTONI PIENI, MATTONI PIENI

NNB-CG - Tassello in nylon passante con codette per fissaggio scaldabagni

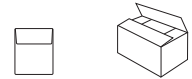
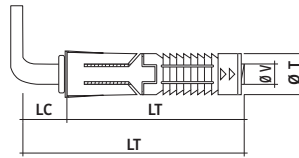

Codice	Descrizione	Ø T mm	LT mm	Ø V mm	LV mm	LC mm	Busta singola	Imballo complessivo
NB10337	Tassello in nylon passante NNB-CG 14x95 con codette	14	75	10	98	18	2 pz	50 buste

Disponibile in blister

Disponibile in blister 4 pz

SXLV-GL - Tassello per fissaggio scaldabagni e caldaie con codetta a L

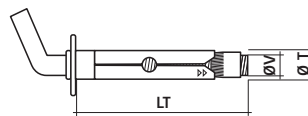

Codice	Descrizione	Ø T mm	LT mm	Ø V mm	LV mm	Scatola singola	Imballo complessivo
NB34180	Tassello SXLV-GL 10x80 con codetta a L	10	80	8	85	50 pz	5 scatole

Disponibile in blister

NCV-TE - Tassello in nylon con tirafondo DIN 571 e rondella

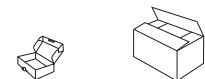
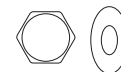
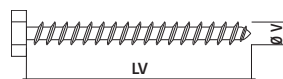
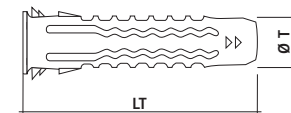

Codice	Descrizione	Ø T mm	LT mm	Ø V mm	LV mm	Scatola singola	Imballo complessivo
NB187844	Tassello NCV-TE 8 in nylon 8x40 con tirafondo 5x50 e rondella	8	40	5	50	100 pz	5 scatole
NB187851	Tassello NCV-TE 10 in nylon 10x50 con tirafondo 6x60 e rondella	10	50	6	60	100 pz	5 scatole
NB187858	Tassello NCV-TE 12 in nylon 12x60 con tirafondo 8x70 e rondella	12	60	8	70	50 pz	5 scatole
NB187865	Tassello NCV-TE 14 in nylon 14x70 con tirafondo 10x80 e rondella	14	70	10	80	25 pz	5 scatole

COLLARI IN ACCIAIO PER TUBI PLUVIALI E FUMI

Collari fermatubo in acciaio disponibili con o senza vite di giunzione e tassello in nylon, in acciaio, in inox o verniciati. La gamma comprende collari per tubi, tubi fumi, tubi PVC e collari isofonici.

MATERIALI DI SUPPORTO CALCESTRUZZO, PIETRA NATURALE, MATTONI PIENI, MATTONE CLS PIENO, MATTONI FORATI

CF-KIT - Collari fermatubo completo di vite e tassello AB

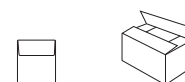
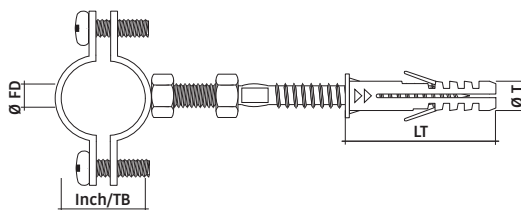
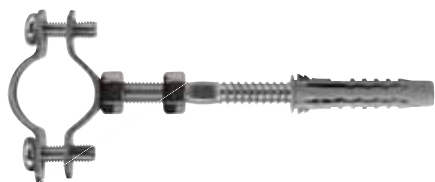

Coppia

Codice	Descrizione	Ø TB Inch	Ø TB mm	Passo dado Ø FD mm	Ø T mm	LT mm	Busta singola	Imballo complessivo
NB11878	Collari fermatubo CF-KIT 16-20 con vite e tassello tipo AB	3/8"	16÷20	M 8	10	50	2 pz	50 buste
NB11885	Collari fermatubo CF-KIT 20-24 con vite e tassello tipo AB	1/2"	20÷24	M 8	10	50	2 pz	50 buste
NB11892	Collari fermatubo CF-KIT 25-30 con vite e tassello tipo AB	3/4"	25÷30	M 8	10	50	2 pz	50 buste
NB11908	Collari fermatubo CF-KIT 32-36 con vite e tassello tipo AB	1"	32÷36	M 8	10	50	2 pz	50 buste
NB11915	Collari fermatubo CF-KIT 38-44 con vite e tassello tipo AB	1.1/4"	38÷44	M 8	10	50	2 pz	25 buste
NB11922	Collari fermatubo CF-KIT 46-50 con vite e tassello tipo AB	1.1/2"	46÷50	M 8	10	50	2 pz	25 buste
NB11939	Collari fermatubo CF-KIT 58-62 con vite e tassello tipo AB	2"	58÷62	M 8	10	50	2 pz	25 buste
NB11942	Collari fermatubo CF-KIT 74-80 con vite e tassello tipo AB	2.1/2"	74÷80	M 8	10	50	2 pz	25 buste
NB11946	Collari fermatubo CF-KIT 84-89 con vite e tassello tipo AB	3"	84÷89	M 8	10	50	2 pz	25 buste
NB11949	Collari fermatubo CF-KIT 112-118 con vite e tassello tipo AB	4"	112÷118	M 8	10	50	2 pz	25 buste

Disponibile in blister 2 pz

CF - Collare fermatubo completo di vite e tassello NC

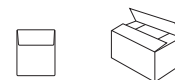
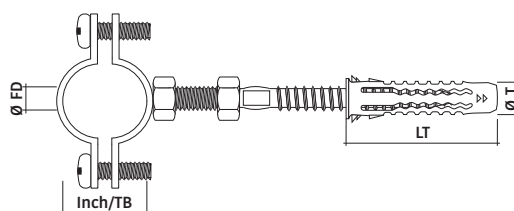
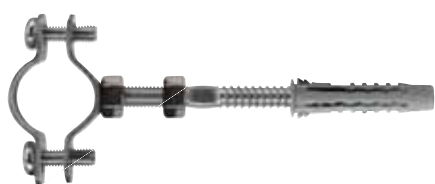

Singolo

Codice	Descrizione	Ø Inch	Ø TB mm	Passo dado Ø FD mm	Ø T mm	LT mm	Busta singola	Imballo complessivo
NB11877	Collari fermatubo CF 16-20 con vite e tassello NC	3/8"	16÷20	M 8	8	40	1 pz	100 buste
NB11884	Collari fermatubo CF 20-24 con vite e tassello NC	1/2"	20÷24	M 8	8	40	1 pz	100 buste
NB11891	Collari fermatubo CF 25-30 con vite e tassello NC	3/4"	25÷30	M 8	8	40	1 pz	100 buste
NB11907	Collari fermatubo CF 32-36 con vite e tassello NC	1"	32÷36	M 8	8	40	1 pz	100 buste
NB11914	Collari fermatubo CF 38-44 con vite e tassello NC	1.1/4"	38÷44	M 8	8	40	1 pz	50 buste
NB11921	Collari fermatubo CF 46-50 con vite e tassello NC	1.1/2"	46÷50	M 8	8	40	1 pz	50 buste
NB11938	Collari fermatubo CF 58-62 con vite e tassello NC	2"	58÷62	M 8	8	40	1 pz	50 buste
NB11945	Collari fermatubo CF 74-80 con vite e tassello NC	2.1/2"	74÷80	M 10	10	50	1 pz	25 buste
NB11952	Collari fermatubo CF 84-89 con vite e tassello NC	3"	84÷89	M 10	10	50	1 pz	25 buste
NB11969	Collari fermatubo CF 112-118 con vite e tassello NC	4"	112÷118	M 10	10	50	1 pz	25 buste
NB11970	Collari fermatubo CF 134-138 con vite e tassello NC	5"	134÷138	M 10	10	50	1 pz	25 buste
NB11975	Collari fermatubo CF 164-172 con vite e tassello NC	6"	164÷172	M 10	10	50	1 pz	25 buste

COLLARI IN ACCIAIO PER TUBI PLUVIALI E FUMI

MATERIALI DI SUPPORTO CALCESTRUZZO, PIETRA NATURALE, MATTONI PIENI, MATTONE CLS PIENO, MATTONE FORATO, MATTONE CLS FORATO

CF-PVC - Coppia di collari per tubi PVC con dado M 10

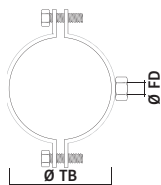

Coppia



Codice	Descrizione	Ø TB mm	Passo dado Ø FD mm	Busta singola	Imballo complessivo
NB12450	Collari CF-PVC 40 per tubi PVC con dado M 10	40	10	2 pz	25 buste
NB12453	Collari CF-PVC 50 per tubi PVC con dado M 10	50	10	2 pz	25 buste
NB12456	Collari CF-PVC 63 per tubi PVC con dado M 10	63	10	2 pz	25 buste
NB12459	Collari CF-PVC 76 per tubi PVC con dado M 10	76	10	2 pz	10 buste
NB12465	Collari CF-PVC 90 per tubi PVC con dado M 10	90	10	2 pz	10 buste
NB12468	Collari CF-PVC 100 per tubi PVC con dado M 10	100	10	2 pz	10 buste
NB12471	Collari CF-PVC 110 per tubi PVC con dado M 10	110	10	2 pz	10 buste
NB12474	Collari CF-PVC 125 per tubi PVC con dado M 10	125	10	2 pz	10 buste
NB12477	Collari CF-PVC 140 per tubi PVC con dado M 10	140	10	2 pz	10 buste
NB12480	Collari CF-PVC 160 per tubi PVC con dado M 10	160	10	2 pz	5 buste
NB12483	Collari CF-PVC 180 per tubi PVC con dado M 10	180	10	2 pz	5 buste
NB12486	Collari CF-PVC 200 per tubi PVC con dado M 10	200	10	2 pz	5 buste
NB12489	Collari CF-PVC 220 per tubi PVC con dado M 10	220	10	2 pz	5 buste
NB12492	Collari CF-PVC 250 per tubi PVC con dado M 10	250	10	2 pz	5 buste
NB12495	Collari CF-PVC 315 per tubi PVC con dado M 10	315	10	2 pz	5 buste

Disponibile in blister 2 pz

CFC-PVC - Coppia di collari per tubi PVC con dado M 10 completi di viti e tasselli in nylon AB

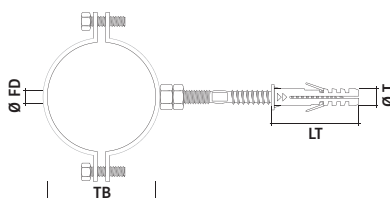

Coppia



Codice	Descrizione	Ø TB mm	Ø T mm	LT mm	Passo dado Ø FD mm	Busta singola	Imballo complessivo
NB12340	Collari CFC-PVC 40 con dado e tassello tipo AB	40	12	60	10	2 pz	25 buste
NB12343	Collari CFC-PVC 50 con dado e tassello tipo AB	50	12	60	10	2 pz	25 buste
NB12346	Collari CFC-PVC 63 con dado e tassello tipo AB	63	12	60	10	2 pz	25 buste
NB12355	Collari CFC-PVC 76 con dado e tassello tipo AB	76	12	60	10	2 pz	25 buste
NB12379	Collari CFC-PVC 90 con dado e tassello tipo AB	90	12	60	10	2 pz	25 buste
NB12386	Collari CFC-PVC 100 con dado e tassello tipo AB	100	12	60	10	2 pz	25 buste
NB12393	Collari CFC-PVC 110 con dado e tassello tipo AB	110	12	60	10	2 pz	25 buste
NB12409	Collari CFC-PVC 125 con dado e tassello tipo AB	125	12	60	10	2 pz	25 buste
NB12412	Collari CFC-PVC 140 con dado e tassello tipo AB	140	12	60	10	2 pz	25 buste
NB12416	Collari CFC-PVC 160 con dado e tassello tipo AB	160	12	60	10	2 pz	25 buste
NB12420	Collari CFC-PVC 180 con dado e tassello tipo AB	180	12	60	10	2 pz	25 buste
NB12423	Collari CFC-PVC 200 con dado e tassello tipo AB	200	12	60	10	2 pz	25 buste
NB12426	Collari CFC-PVC 220 con dado e tassello tipo AB	220	12	60	10	2 pz	25 buste
NB12429	Collari CFC-PVC 250 con dado e tassello tipo AB	250	12	60	10	2 pz	25 buste
NB12432	Collari CFC-PVC 315 con dado e tassello tipo AB	315	12	60	10	2 pz	25 buste

Disponibile in blister 2 pz

COLLARI IN ACCIAIO PER TUBI PLUVIALI E FUMI

MATERIALI DI SUPPORTO CALCESTRUZZO, PIETRA NATURALE, MATTONI PIENI, MATTONE CLS PIENO, MATTONE FORATO, MATTONE CLS FORATO

CFX A2 - Coppia di collari Inox A2 con dado AISI 304

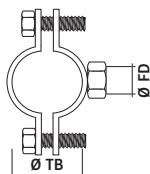

Coppia

Codice	Descrizione	Ø TB mm	Passo dado Ø FD mm	Busta singola	Imballo complessivo
NB12499	Collari inox CFX 30-36 con dado	30-36	M8	2 pz	10 buste
NB12452	Collari inox CFX 38-44 con dado	38-44	M8	2 pz	10 buste
NB12455	Collari inox CFX 44-50 con dado	44-50	M8	2 pz	10 buste
NB12458	Collari inox CFX 56-62 con dado	56-62	M8	2 pz	5 buste
NB12461	Collari inox CFX 76-80 con dado	76-80	M10	2 pz	5 buste
NB12464	Collari inox CFX 90-100 con dado	90-100	M10	2 pz	5 buste
NB12467	Collari inox CFX 100-110 con dado	100-110	M10	2 pz	5 buste
NB12470	Collari inox CFX 110-120 con dado	110-120	M10	2 pz	5 buste
NB12473	Collari inox CFX 125-130 con dado	125-130	M10	2 pz	5 buste
NB12476	Collari inox CFX 140-150 con dado	140-150	M10	2 pz	5 buste
NB12479	Collari inox CFX 152-160 con dado	152-160	M10	2 pz	5 buste
NB12482	Collari inox CFX 180 con dado	180	M10	2 pz	5 buste
NB12485	Collari inox CFX 200 con dado	200	M10	2 pz	5 buste

CFX-C A2 - Coppia di collari Inox A2 con dado AISI 304 completi di viti e tasselli

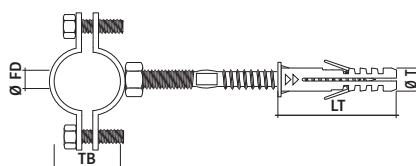

Coppia

Codice	Descrizione	Ø T mm	LT mm	Ø TB mm	Passo dado Ø FD mm	Busta singola	Imballo complessivo
NB12430	Collari inox CFX-C 16-20 con dado, viti e tassello tipo AB	10	50	16-20	M 8	2 pz	10 buste
NB12433	Collari inox CFX-C 18-24 con dado, viti e tassello tipo AB	10	50	18-24	M 8	2 pz	10 buste
NB12436	Collari inox CFX-C 25-30 con dado, viti e tassello tipo AB	10	50	25-30	M 8	2 pz	10 buste
NB12439	Collari inox CFX-C 30-36 con dado, viti e tassello tipo AB	10	50	30-36	M 8	2 pz	10 buste
NB12442	Collari inox CFX-C 38-44 con dado, viti e tassello tipo AB	10	50	38-44	M 8	2 pz	10 buste
NB12445	Collari inox CFX-C 44-50 con dado, viti e tassello tipo AB	10	50	44-50	M 8	2 pz	10 buste
NB12448	Collari inox CFX-C 56-62 con dado, viti e tassello tipo AB	10	50	56-62	M 8	2 pz	5 buste
NB12451	Collari inox CFX-C 76-80 con dado, viti e tassello tipo AB	12	60	76-80	M 10	2 pz	5 buste
NB12454	Collari inox CFX-C 90-100 con dado, viti e tassello tipo AB	12	60	90-100	M 10	2 pz	5 buste
NB12457	Collari inox CFX-C 100-110 con dado, viti e tassello tipo AB	12	60	100-110	M 10	2 pz	5 buste
NB12460	Collari inox CFX-C 110-120 con dado, viti e tassello tipo AB	12	60	110-120	M 10	2 pz	5 buste
NB12463	Collari inox CFX-C 125-130 con dado, viti e tassello tipo AB	12	60	125-130	M 10	2 pz	5 buste
NB12466	Collari inox CFX-C 140-150 con dado, viti e tassello tipo AB	12	60	140-150	M 10	2 pz	5 buste
NB12469	Collari inox CFX-C 152-160 con dado, viti e tassello tipo AB	12	60	152-160	M 10	2 pz	5 buste
NB12472	Collari inox CFX-C Kit 180 con dado, viti e tassello tipo AB	12	60	180	M 10	2 pz	5 buste
NB12475	Collari inox CFX-C Kit 200 con dado, viti e tassello tipo AB	12	60	200	M 10	2 pz	5 buste

Disponibile in blister 2 pz

COLLARI IN ACCIAIO PER TUBI PLUVIALI E FUMI

MATERIALI DI SUPPORTO CALCESTRUZZO, PIETRA NATURALE, MATTONI PIENI, MATTONE FORATO, MATTONE CLS FORATO

CF-ISO - Collari isofonici con gomma EPDM

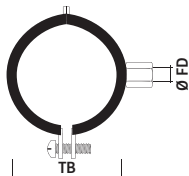

Codice	Descrizione	Ø Inch	Ø TB mm	Passo dado Ø FD mm	Scatola singola
NB10641	Collari isofonici CF-ISO 15-19 con gomma EPDM	3/8"	15÷19	M8/10	50 pz
NB10658	Collari isofonici CF-ISO 20-24 con gomma EPDM	1/2"	20÷24	M8/10	50 pz
NB10665	Collari isofonici CF-ISO 25-30 con gomma EPDM	3/4"	25÷30	M8/10	50 pz
NB10672	Collari isofonici CF-ISO 32-36 con gomma EPDM	1"	32÷36	M8/10	50 pz
NB10689	Collari isofonici CF-ISO 38-44 con gomma EPDM	1.1/4"	38÷44	M8/10	50 pz
NB10696	Collari isofonici CF-ISO 44-50 con gomma EPDM	1.1/2"	44÷50	M8/10	50 pz
NB10702	Collari isofonici CF-ISO 54-58 con gomma EPDM	-	54÷58	M8/10	50 pz
NB10719	Collari isofonici CF-ISO 59-65 con gomma EPDM	2"	59÷65	M8/10	50 pz
NB10726	Collari isofonici CF-ISO 62-67 con gomma EPDM	-	62÷67	M8/10	50 pz
NB10733	Collari isofonici CF-ISO 74-80 con gomma EPDM	2.1/2"	74÷80	M8/10	50 pz
NB10740	Collari isofonici CF-ISO 83-93 con gomma EPDM	3"	83÷93	M8/10	50 pz
NB10757	Collari isofonici CF-ISO 95-103 con gomma EPDM	-	95÷103	M8/10	50 pz
NB10771	Collari isofonici CF-ISO 108-118 con gomma EPDM	4"	108÷118	M8/10	50 pz
NB10788	Collari isofonici CF-ISO 121-127 con gomma EPDM	-	121÷127	M8/10	50 pz
NB10795	Collari isofonici CF-ISO 132-143 con gomma EPDM	5"	132÷143	M8/10	50 pz
NB10801	Collari isofonici CF-ISO 159-169 con gomma EPDM	6"	159÷169	M8/10	50 pz
NB10818	Collari isofonici CF-ISO 210-215 con gomma EPDM	-	210÷215	M8/10	50 pz
NB10825	Collari isofonici CF-ISO216-225 con gomma EPDM	8"	216÷225	M8/10	50 pz

CP - Collari per tubo pluviale in lamiera zincata completo di vite e tassello

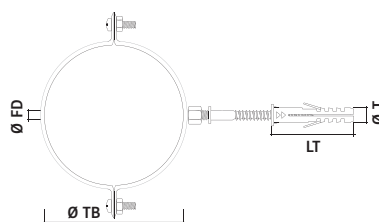

Codice	Descrizione	Ø T mm	LT mm	Ø TB mm	Passo dado Ø FD mm	Busta singola	Imballo complessivo
NB13060	Collari per tubo pluviale CP 60 in lamiera zincata con vite e tassello	8	40	60	6	2 pz	25 buste
NB13093	Collari per tubo pluviale CP 80 in lamiera zincata con vite e tassello	10	50	80	8	2 pz	25 buste
NB13100	Collari per tubo pluviale CP 90 in lamiera zincata con vite e tassello	10	50	90	8	2 pz	25 buste
NB13109	Collari per tubo pluviale CP 100 in lamiera zincata con vite e tassello	10	50	100	8	2 pz	25 buste
NB13112	Collari per tubo pluviale CP 110 in lamiera zincata con vite e tassello	10	50	110	8	2 pz	25 buste
NB13116	Collari per tubo pluviale CP 120 in lamiera zincata con vite e tassello	10	50	120	8	2 pz	25 buste
NB13118	Collari per tubo pluviale CP 140 in lamiera zincata con vite e tassello	10	50	140	8	2 pz	25 buste
NB13120	Collari per tubo pluviale CP 160 in lamiera zincata con vite e tassello	10	50	160	8	2 pz	25 buste
NB13124	Collari per tubo pluviale CP 180 in lamiera zincata con vite e tassello	10	50	180	8	2 pz	25 buste
NB13126	Collari per tubo pluviale CP 200 in lamiera zincata con vite e tassello	10	50	200	8	2 pz	25 buste

Disponibile in blister 2 pz

COLLARI IN ACCIAIO PER TUBI PLUVIALI E FUMI

MATERIALI DI SUPPORTO CALCESTRUZZO, PIETRA NATURALE, MATTONI PIENI, MATTONE FORATO, MATTONE CLS FORATO

CP-TMRO - Collari per tubo pluviale testa di moro completo di vite e tassello

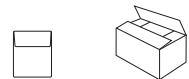
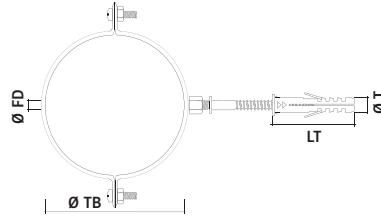
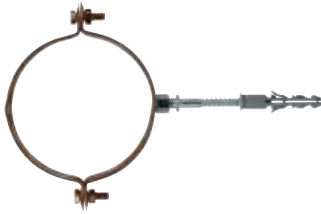

2 pezzi

Codice	Descrizione	Ø T mm	LT mm	Ø TB mm	Passo dado Ø FD mm	Busta singola	Imballo complessivo
NB15912	Collari per tubo pluviale testa di moro CP-TMRO 80 con vite e tassello	10	60	80	8	2 pz	25 buste
NB15929	Collari per tubo pluviale testa di moro CP-TMRO 100 con vite e tassello	10	60	100	8	2 pz	25 buste
NB15936	Collari per tubo pluviale testa di moro CP-TMRO 120 con vite e tassello	10	60	120	8	2 pz	25 buste

Disponibile in blister 2 pz

CP-RA - Collari per tubo pluviale in rame completo di vite e tassello

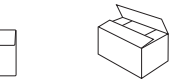
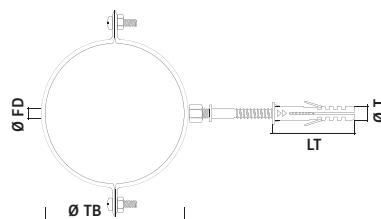
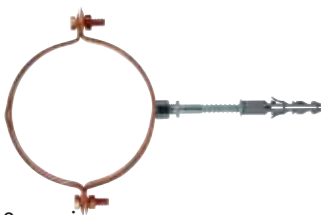

2 pezzi

Codice	Descrizione	Ø T mm	LT mm	Ø TB mm	Passo dado Ø FD mm	Busta singola	Imballo complessivo
NB13154	Collari per tubo pluviale in rame CP-RA 80 con vite e tassello	10	60	80	8	2 pz	25 buste
NB13161	Collari per tubo pluviale in rame CP-RA 100 con vite e tassello	10	60	100	8	2 pz	25 buste
NB13178	Collari per tubo pluviale in rame CP-RA 120 con vite e tassello	10	60	120	8	2 pz	25 buste

Disponibile in blister 2 pz

CP-X - Collari per tubo pluviale in lamiera inox completo di vite e tassello

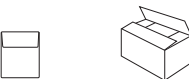
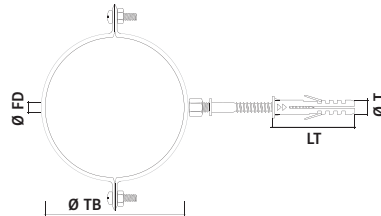
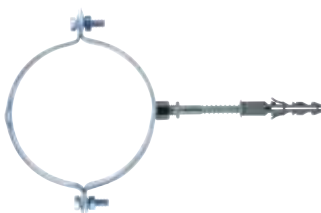

2 pezzi

Codice	Descrizione	Ø T mm	LT mm	Ø TB mm	Passo dado Ø FD mm	Busta singola	Imballo complessivo
NB13185	Collari per tubo pluviale in lamiera inox CP-X 80 con vite e tassello	10	60	80	8	2 pz	25 buste
NB13192	Collari per tubo pluviale in lamiera inox CP-X 100 con vite e tassello	10	60	100	8	2 pz	25 buste
NB13208	Collari per tubo pluviale in lamiera inox CP-X 120 con vite e tassello	10	60	120	8	2 pz	25 buste

Disponibile in blister 2 pz

COLLARI IN ACCIAIO PER TUBI PLUVIALI E FUMI

MATERIALI DI SUPPORTO CALCESTRUZZO, PIETRA NATURALE, MATTONI PIENI, MATTONE FORATO, MATTONE CLS FORATO

CF-RX - Collare regolabile per tubi per fumi in inox verniciato completo di vite e tassello

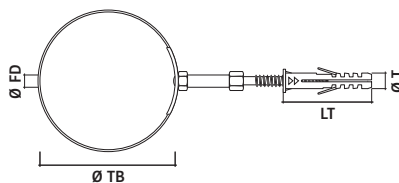

Codice	Descrizione	Ø T mm	LT mm	Ø TB mm	Passo dado Ø FD mm	Scatola singola
NB13215	Collare regolabile per fumi CF-RX 80-140 bianco con vite e tassello tipo AB	10	60	80-140	-	20 pz
NB13222	Collare regolabile per fumi CF-RX 80-140 marrone con vite e tassello tipo AB	10	60	80-140	-	20 pz
NB13239	Collare regolabile per fumi CF-RX 80-140 inox con vite e tassello tipo AB	10	60	80-140	-	20 pz
NB13246	Collare regolabile per fumi CF-RX 140-200 bianco con vite e tassello tipo AB	10	60	140-200	-	20 pz
NB13253	Collare regolabile per fumi CF-RX 140-200 marrone con vite e tassello tipo AB	10	60	140-200	-	20 pz
NB13260	Collare regolabile per fumi CF-RX 140-200 inox con vite e tassello tipo AB	10	60	140-200	-	20 pz

COLLARI IN ACCIAIO PER TUBI PLUVIALI E FUMI

MATERIALI DI SUPPORTO CALCESTRUZZO, PIETRA NATURALE, MATTONI PIENI, MATTONE CLS PIENO, MATTONI FORATI, MATTONE CLS FORATO

CL-R - Collare in rame M6 completo di vite di giunzione

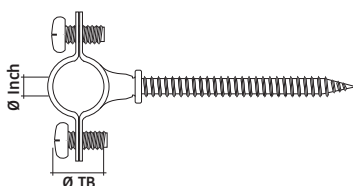

Codice	Descrizione	Ø Inch	Ø TB mm	Passo dado Ø FD mm	Scatola singola	Imballo complessivo
NB49795	Collare in rame CL-R 10 con vite di giunzione	1/8"	10	M 6	200 pz	5 scatole
NB49801	Collare in rame CL-R 12 con vite di giunzione	-	12	M 6	200 pz	5 scatole
NB49818	Collare in rame CL-R 14 con vite di giunzione	1/4"	14	M 6	200 pz	5 scatole
NB49825	Collare in rame CL-R 16 con vite di giunzione	-	16	M 6	200 pz	5 scatole
NB49832	Collare in rame CL-R 18 con vite di giunzione	3/8"	18	M 6	200 pz	5 scatole
NB49849	Collare in rame CL-R 22 con vite di giunzione	1/2"	22	M 6	100 pz	5 scatole
NB49856	Collare in rame CL-R 28 con vite di giunzione	3/4"	28	M 6	100 pz	5 scatole
NB49865	Collare in rame CL-R 35 con vite di giunzione	-	35	M 6	100 pz	5 scatole
NB49887	Collare in rame CL-R 42 con vite di giunzione	1.1/4"	42	M 6	100 pz	2 scatole

COLLARI IN ACCIAIO PER TUBI PLUVIALI E FUMI

CL-R BAG - Collari in rame M6 completi di viti di giunzione in rame e tassello NC

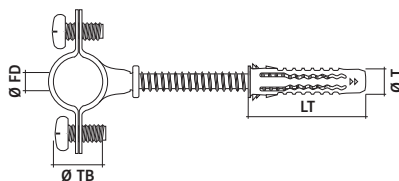
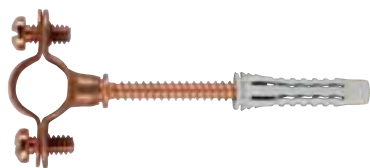

Codice	Descrizione	Ø T mm	LT mm	Ø Inch	Ø TB mm	Passo dado Ø FD mm	Busta singola
NB49780	Collari in rame CL-R Bag 10 con viti di giunzione e tassello NC	6	30	1/8"	10	M 6	10 pz
NB49781	Collari in rame CL-R Bag 12 con viti di giunzione e tassello NC	6	30	-	12	M 6	10 pz
NB49782	Collari in rame CL-R Bag 14 con viti di giunzione e tassello NC	6	30	1/4"	14	M 6	10 pz
NB49783	Collari in rame CL-R Bag 16 con viti di giunzione e tassello NC	6	30	-	16	M 6	10 pz
NB49784	Collari in rame CL-R Bag 18 con viti di giunzione e tassello NC	6	30	3/8"	18	M 6	10 pz
NB49785	Collari in rame CL-R Bag 22 con viti di giunzione e tassello NC	6	30	1/2"	22	M 6	10 pz
NB49786	Collari in rame CL-R Bag 28 con viti di giunzione e tassello NC	6	30	3/4"	28	M 6	10 pz
NB49788	Collari in rame CL-R Bag 35 con viti di giunzione e tassello NC	6	30	-	35	M 6	10 pz
NB49790	Collari in rame CL-R Bag 42 con viti di giunzione e tassello NC	6	30	1.1/4"	42	M 6	10 pz

Disponibile in blister

CL - Collari in lamiera per elettricisti e idraulici

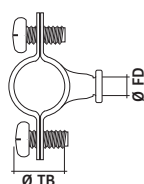

Codice	Descrizione	Ø Inch	Ø TB mm	Passo dado Ø FD mm	Scatola singola	Imballo complessivo
NB13277	Collari in lamiera CL 8	-	8	M 6	100 pz	10 scatole
NB13284	Collari in lamiera CL 10	1/8"	10	M 6	100 pz	10 scatole
NB13291	Collari in lamiera CL 12	-	12	M 6	100 pz	10 scatole
NB13307	Collari in lamiera CL 14	1/4"	14	M 6	100 pz	10 scatole
NB13314	Collari in lamiera CL 15	-	15	M 6	100 pz	5 scatole
NB13321	Collari in lamiera CL 16	-	16	M 6	100 pz	5 scatole
NB13338	Collari in lamiera CL 18	3/8"	18	M 6	100 pz	5 scatole
NB13345	Collari in lamiera CL 20	-	20	M 6	100 pz	5 scatole
NB13352	Collari in lamiera CL 22	1/2"	22	M 6	100 pz	5 scatole
NB13369	Collari in lamiera CL 24	-	24	M 6	100 pz	5 scatole
NB13376	Collari in lamiera CL 26	3/4"	26	M 6	100 pz	5 scatole
NB13383	Collari in lamiera CL 28	-	28	M 6	100 pz	5 scatole
NB13390	Collari in lamiera CL 30	-	30	M 6	100 pz	5 scatole
NB13406	Collari in lamiera CL 32	1"	32	M 6	100 pz	5 scatole
NB13413	Collari in lamiera CL 35	-	35	M 6	50 pz	5 scatole
NB13420	Collari in lamiera CL 38	-	38	M 6	50 pz	5 scatole
NB13437	Collari in lamiera CL 42	1.1/4"	42	M 6	50 pz	5 scatole
NB13451	Collari in lamiera CL 50	-	50	M 6	50 pz	5 scatole
NB13468	Collari in lamiera CL 54	-	54	M 6	50 pz	2 scatole
NB13475	Collari in lamiera CL 60	2"	60	M 6	50 pz	2 scatole
NB13482	Collari in lamiera CL 63	-	63	M 6	50 pz	2 scatole
NB13499	Collari in lamiera CL 67	-	67	M 6	50 pz	2 scatole

COLLARI IN ACCIAIO PER TUBI PLUVIALI E FUMI

MATERIALI DI SUPPORTO CALCESTRUZZO, PIETRA NATURALE, MATTONI PIENI, MATTONE CLS PIENO, MATTONI FORATI, MATTONE CLS FORATO

CL - V - Collari in lamiera per elettricisti e idraulici con vite e tassello

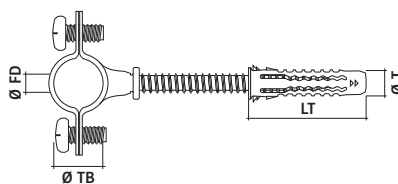
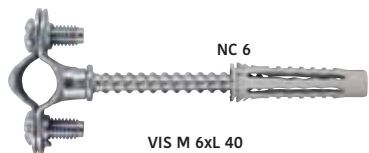

Codice	Descrizione	Ø T mm	LT mm	Ø Inch	Ø TB mm	Ø FD mm	Scatola singola
NB13510	Collari in lamiera CL-V 8 con vite e tassello NC	6	30	-	8	M 6	50 pz
NB13512	Collari in lamiera CL-V 10 con vite e tassello NC	6	30	1/8"	10	M 6	50 pz
NB13514	Collari in lamiera CL-V 12 con vite e tassello NC	6	30	-	12	M 6	50 pz
NB13516	Collari in lamiera CL-V 14 con vite e tassello NC	6	30	1/4"	14	M 6	50 pz
NB13518	Collari in lamiera CL-V 15 con vite e tassello NC	6	30	-	15	M 6	50 pz
NB13520	Collari in lamiera CL-V 16 con vite e tassello NC	6	30	-	16	M 6	50 pz
NB13522	Collari in lamiera CL-V 18 con vite e tassello NC	6	30	3/8"	18	M 6	50 pz
NB13524	Collari in lamiera CL-V 20 con vite e tassello NC	6	30	-	20	M 6	50 pz
NB13526	Collari in lamiera CL-V 22 con vite e tassello NC	6	30	1/2"	22	M 6	50 pz
NB13528	Collari in lamiera CL-V 24 con vite e tassello NC	6	30	-	24	M 6	50 pz
NB13530	Collari in lamiera CL-V 26 con vite e tassello NC	6	30	3/4"	26	M 6	50 pz
NB13532	Collari in lamiera CL-V 28 con vite e tassello NC	6	30	-	28	M 6	50 pz
NB13534	Collari in lamiera CL-V 30 con vite e tassello NC	6	30	-	30	M 6	25 pz
NB13536	Collari in lamiera CL-V 32 con vite e tassello NC	6	30	1"	32	M 6	25 pz
NB13538	Collari in lamiera CL-V 35 con vite e tassello NC	6	30	-	35	M 6	25 pz
NB13540	Collari in lamiera CL-V 38 con vite e tassello NC	6	30	-	38	M 6	25 pz
NB13541	Collari in lamiera CL-V 40 con vite e tassello NC	6	30	-	40	M 6	25 pz
NB13542	Collari in lamiera CL-V 42 con vite e tassello NC	6	30	1.1/4"	42	M 6	25 pz
NB13546	Collari in lamiera CL-V 50 con vite e tassello NC	6	30	-	50	M 6	25 pz
NB13548	Collari in lamiera CL-V 54 con vite e tassello NC	6	30	-	54	M 6	25 pz
NB13550	Collari in lamiera CL-V 60 con vite e tassello NC	6	30	2"	60	M 6	25 pz
NB13552	Collari in lamiera CL-V 63 con vite e tassello NC	6	30	-	63	M 6	25 pz
NB13554	Collari in lamiera CL-V 67 con vite e tassello NC	6	30	-	67	M 6	25 pz

FISSAGGI IDRAULICI ED ELETTRICI

CV - Cavallotti ad un labbro



Codice	Descrizione	Ø Inch	Ø TB mm	H fascetta mm	Scatola singola	Imballo complessivo
NB13864	Cavallotti ad un labbro CV 6	-	6		100 pz	16 scatole
NB13871	Cavallotti ad un labbro CV 8	1/8"	8		100 pz	16 scatole
NB13888	Cavallotti ad un labbro CV 10	1/4"	10		100 pz	16 scatole
NB13895	Cavallotti ad un labbro CV 12	-	12		100 pz	16 scatole
NB13901	Cavallotti ad un labbro CV 14	-	14		100 pz	16 scatole
NB13918	Cavallotti ad un labbro CV 15	3/8"	15		100 pz	10 scatole
NB13925	Cavallotti ad un labbro CV 16	-	16		100 pz	10 scatole
NB13932	Cavallotti ad un labbro CV 18	-	18		100 pz	10 scatole
NB13949	Cavallotti ad un labbro CV 20	1/2"	20		100 pz	10 scatole
NB13956	Cavallotti ad un labbro CV 22	-	22		100 pz	5 scatole
NB13963	Cavallotti ad un labbro CV 24	3/4"	24		100 pz	5 scatole
NB13970	Cavallotti ad un labbro CV 28	-	28		100 pz	5 scatole
NB13987	Cavallotti ad un labbro CV 30	-	30		100 pz	5 scatole
NB13994	Cavallotti ad un labbro CV 32	1"	32		100 pz	5 scatole
NB14014	Cavallotti ad un labbro CV 40	-	40		50 pz	5 scatole
NB14038	Cavallotti ad un labbro CV 47	1.1/2"	47		50 pz	5 scatole

CVD - Cavallotti a doppio labbro



Foro asola h 6,2 mm - spessore 0,9 mm

Codice	Descrizione	Ø Inch	Ø TB mm	H fascetta mm	Scatola singola	Imballo complessivo
NB14069	Cavallotti a doppio labbro CVD 10	1/8"	10	6,2	100 pz	16 scatole
NB14076	Cavallotti a doppio labbro CVD 12	1/4"	12	6,2	100 pz	16 scatole
NB14083	Cavallotti a doppio labbro CVD 14	-	14	6,2	100 pz	16 scatole
NB14106	Cavallotti a doppio labbro CVD 16	3/8"	16	6,2	100 pz	10 scatole
NB14113	Cavallotti a doppio labbro CVD 18	-	18	6,2	100 pz	10 scatole
NB14120	Cavallotti a doppio labbro CVD 20	1/2"	20	6,2	100 pz	5 scatole
NB14137	Cavallotti a doppio labbro CVD 22	-	22	6,2	100 pz	5 scatole
NB14144	Cavallotti a doppio labbro CVD 24	-	24	6,2	100 pz	5 scatole
NB14151	Cavallotti a doppio labbro CVD 26	3/4"	26	6,2	100 pz	5 scatole
NB14168	Cavallotti a doppio labbro CVD 28	-	28	6,2	100 pz	5 scatole
NB14175	Cavallotti a doppio labbro CVD 30	-	30	6,2	100 pz	5 scatole
NB14182	Cavallotti a doppio labbro CVD 32	1"	32	6,2	100 pz	5 scatole
NB14199	Cavallotti a doppio labbro CVD 37	-	37	6,2	50 pz	5 scatole
NB14205	Cavallotti a doppio labbro CVD 40	-	40	6,2	50 pz	5 scatole
NB14229	Cavallotti a doppio labbro CVD 47	1.1/2"	47	6,2	50 pz	5 scatole
NB14236	Cavallotti a doppio labbro CVD 50	-	50	6,2	50 pz	5 scatole
NB14243	Cavallotti a doppio labbro CVD 54	-	54	6,2	50 pz	2 scatole

FISSAGGI IDRAULICI ED ELETTRICI

CVP - Cavallotti pesanti ad un labbro



Codice	Descrizione	Ø Inch	Ø TB mm	H fascetta mm	Scatola singola	Imballo complessivo
NB44356	Cavallotti pesanti ad un labbro CVP 12	-	12	14	100 pz	10 scatole
NB44363	Cavallotti pesanti ad un labbro CVP 14	-	14	14	100 pz	10 scatole
NB44370	Cavallotti pesanti ad un labbro CVP 16	-	16	14	100 pz	10 scatole
NB44387	Cavallotti pesanti ad un labbro CVP 18	-	18	14	100 pz	5 scatole
NB43236	Cavallotti pesanti ad un labbro CVP 21	-	21	14	100 pz	5 scatole
NB43243	Cavallotti pesanti ad un labbro CVP 27	-	27	14	100 pz	5 scatole
NB43250	Cavallotti pesanti ad un labbro CVP 34	-	34	15	100 pz	5 scatole

CAV - Cavallotti in filo zincato con dadi e rondelle per ancoraggio tubi su profili

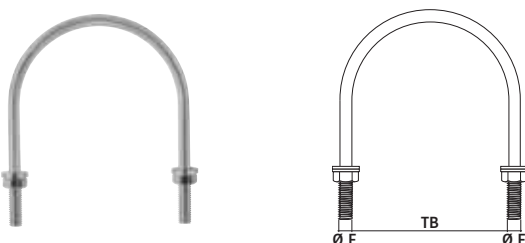

Codice	Descrizione	Ø TB mm	Ø F mm	Scatola singola	Imballo complessivo
NB16506	Cavallotti in filo zincato CAV 18 con dadi e rondelle	18	M 6	100 pz	5 scatole
NB16513	Cavallotti in filo zincato CAV 22 con dadi e rondelle	22	M 6	100 pz	5 scatole
NB16520	Cavallotti in filo zincato CAV 27 con dadi e rondelle	27	M 6	100 pz	5 scatole
NB16537	Cavallotti in filo zincato CAV 34 con dadi e rondelle	34	M 6	100 pz	5 scatole
NB16544	Cavallotti in filo zincato CAV 43 con dadi e rondelle	43	M 6	100 pz	2 scatole
NB16551	Cavallotti in filo zincato CAV 49 con dadi e rondelle	49	M 8	100 pz	1 scatola
NB16568	Cavallotti in filo zincato CAV 61 con dadi e rondelle	61	M 8	100 pz	1 scatola
NB16582	Cavallotti in filo zincato CAV 77 con dadi e rondelle	77	M 8	100 pz	1 scatola
NB16599	Cavallotti in filo zincato CAV 89 con dadi e rondelle	89	M 8	100 pz	1 scatola
NB16605	Cavallotti in filo zincato CAV 102 con dadi e rondelle	102	M 8	100 pz	1 scatola
NB16612	Cavallotti in filo zincato CAV 105 con dadi e rondelle	105	M 8	100 pz	1 scatola
NB16636	Cavallotti in filo zincato CAV 125 con dadi e rondelle	125	M 8	100 pz	1 scatola
NB16643	Cavallotti in filo zincato CAV 155 con dadi e rondelle	155	M 8	20 pz	5 scatole

VITI DI GIUNZIONE

Viti di giunzione a doppio filetto zincato bianco con passo metrico e passo legno

MATERIALI DI SUPPORTO CALCESTRUZZO, PIETRA NATURALE, MATTONI PIENI

VCG - Viti di giunzione a doppio filetto

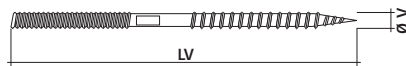

Codice	Descrizione	Ø V mm	LV mm	Busta singola	Imballo complessivo
NB11709	Viti di giunzione a doppio filetto VCG 6x80 tropicalizzate	6	80	200 pz	10 scatole
NB11716	Viti di giunzione a doppio filetto VCG 8x90	8	90	100 pz	5 scatole
NB11723	Viti di giunzione a doppio filetto VCG 8x100	8	100	100 pz	5 scatole
NB11730	Viti di giunzione a doppio filetto VCG 8x110	8	110	100 pz	5 scatole
NB11747	Viti di giunzione a doppio filetto VCG 8x160	8	160	100 pz	5 scatole
NB11754	Viti di giunzione a doppio filetto VCG 10x100	10	100	50 pz	5 scatole
NB11761	Viti di giunzione a doppio filetto VCG 10x120	10	120	50 pz	5 scatole
NB11778	Viti di giunzione a doppio filetto VCG 10x140	10	140	50 pz	5 scatole
NB11785	Viti di giunzione a doppio filetto VCG 10x180	10	180	50 pz	5 scatole
NB29896	Viti di giunzione a doppio filetto VCG 10x230	10	230	50 pz	5 scatole

VCG-A - Vite di giunzione a doppio filetto con tassello in nylon

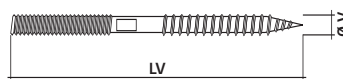
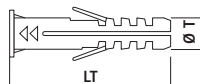

Codice	Descrizione	Ø T mm	LT mm	Ø V mm	L mm	Scatola singola
NB11556	Vite di giunzione a doppio filetto trop. VCG 6x80 con tassello AB 10x50	10	50	6	80	200 pz
NB11563	Vite di giunzione a doppio filetto VCG 8x90 con tassello AB 10x60	10	60	8	90	100 pz
NB11570	Vite di giunzione a doppio filetto VCG 8x100 con tassello AB 10x60	10	60	8	100	100 pz
NB11587	Vite di giunzione a doppio filetto VCG 8x110 con tassello AB 10x60	10	60	8	110	100 pz
NB11594	Vite di giunzione a doppio filetto VCG 8x160 con tassello AB 10x60	10	60	8	160	50 pz
NB11600	Vite di giunzione a doppio filetto VCG 10x100 con tassello AB 12x60	12	60	10	100	50 pz
NB11617	Vite di giunzione a doppio filetto VCG 10x120 con tassello AB 12x60	12	60	10	120	25 pz
NB11624	Vite di giunzione a doppio filetto VCG 10x140 con tassello AB 14x80	14	80	10	140	25 pz
NB11631	Vite di giunzione a doppio filetto VCG 10x180 con tassello AB 14x80	14	80	10	180	25 pz
NB11648	Vite di giunzione a doppio filetto VCG 10x230 con tassello AB 14x80	14	80	10	230	25 pz

FISSAGGI PER IDRO-TERMO-SANITARI

MATERIALI DI SUPPORTO CALCESTRUZZO, PIETRA NATURALE, MATTONI PIENI, MATTONI FORATI

VIS - Viti di giunzione doppio passo metrico e legno per collari

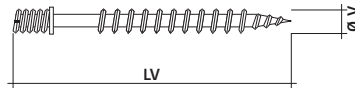

Codice	Descrizione	Ø V mm	LV mm	Scatola singola
NB11792	Viti di giunzione doppio passo metrico VIS 6x30	6	30	250 pz
NB41119	Viti di giunzione doppio passo metrico VIS 6x40	6	40	250 pz
NB11808	Viti di giunzione doppio passo metrico VIS 8x60	8	60	250 pz

VIS-AB - Viti di giunzione doppio passo metrico e legno per collari con tassello in nylon AB

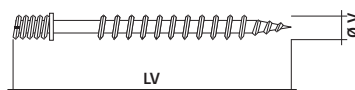
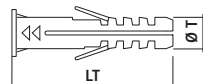

Codice	Descrizione	Ø T mm	LT mm	Ø V mm	LV mm	Scatola singola
NB11655	Vite di giunzione doppio passo metrico/legno VIS 6x30 con tassello AB 6x30	6	30	6	30	200 pz
NB11662	Vite di giunzione doppio passo metrico/legno VIS 6x40 con tassello AB 6x30	6	30	6	40	200 pz
NB11679	Vite di giunzione doppio passo metrico/legno VIS 8x60 con tassello AB 8x40	8	40	8	60	200 pz

VIS-NC - Viti di giunzione doppio passo metrico e legno per collari con tassello in nylon NC

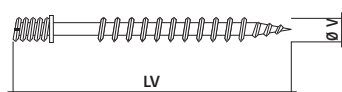
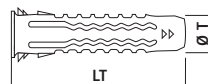

Codice	Descrizione	Ø T mm	LT mm	Ø V mm	LV mm	Scatola singola
NB11650	Vite di giunzione doppio passo metrico/legno VIS 6x40 con tassello NC 6x30	6	30	6	40	100 pz

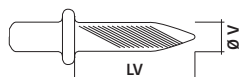
CH - Chiodo con collarino in acciaio temperato

Codice	Descrizione	Ø V mm	LV mm	Scatola singola	Imballo complessivo
NB9719	Chiodo con collarino in acciaio temperato 4x19	4	19	200 pz	5 scatole
NB9722	Chiodo con collarino in acciaio temperato 4x22	4	22	200 pz	5 scatole

CHP - Punzone per chiodo CH

Codice	Descrizione	Scatola singola	Imballo complessivo
NB9700	Punzone CHP per chiodo CH	1 pz	10 scatole
NB9702	Punzone magnetico CHP/M per chiodo CH 	1 pz	10 scatole

BTS - Bandella in tessuto sintetico

Codice	Descrizione	H mm	L m	Scatola singola	Imballo complessivo
NB9705	Bandella in tessuto sintetico BTS 10 m	16	10	1 pz	10 scatole
NB9708	Bandella in tessuto sintetico BTS 25 m	16	25	1 pz	10 scatole
NB9710	Bandella in tessuto sintetico BTS 50 m	20	50	1 pz	10 scatole

BP - Bandella perforata

Codice	Descrizione	H mm	L m	Spessore mm	Scatola singola	Imballo complessivo
NB13697	Bandella perforata ondulata BP-O 12x0,8 mm M10	12	10	0,8	1 pz	10 scatole
NB13703	Bandella perforata ondulata BP-O 17x0,8 mm M10	17	10	0,8	1 pz	10 scatole
NB13710	Bandella dritta perforata BP-O 26x0,6 mm M10	26	10	0,6	1 pz	10 scatole

FASCETTE IN NYLON

MATERIALI DI SUPPORTO Per cablaggi elettrici

FSC-B - Fascette in nylon bianco

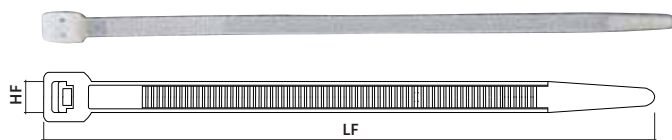

Codice	Descrizione	LF mm	HF mm	Busta singola	Imballo complessivo
NB14400	Fascette in nylon FSC-B 80x2,4 mm bianche	80	2,4	100 pz	300 buste
NB14403	Fascette in nylon FSC-B 100x2,5 mm bianche	100	2,5	100 pz	300 buste
NB14406	Fascette in nylon FSC-B 140x2,5 mm bianche	140	2,5	100 pz	250 buste
NB14409	Fascette in nylon FSC-B 160x2,5 mm bianche	160	2,5	100 pz	200 buste
NB14412	Fascette in nylon FSC-B 200x2,5 mm bianche	200	2,5	100 pz	200 buste
NB14415	Fascette in nylon FSC-B 140x3,6 mm bianche	140	3,6	100 pz	200 buste
NB14418	Fascette in nylon FSC-B 200x3,6 mm bianche	200	3,6	100 pz	120 buste
NB14421	Fascette in nylon FSC-B 290x3,6 mm bianche	290	3,6	100 pz	120 buste
NB14424	Fascette in nylon FSC-B 360x3,6 mm bianche	360	3,6	100 pz	90 buste
NB14427	Fascette in nylon FSC-B 160x4,8 mm bianche	160	4,8	100 pz	100 buste
NB14430	Fascette in nylon FSC-B 200x4,8 mm bianche	200	4,8	100 pz	100 buste
NB14433	Fascette in nylon FSC-B 250x4,8 mm bianche	250	4,8	100 pz	100 buste
NB14436	Fascette in nylon FSC-B 290x4,8 mm bianche	290	4,8	100 pz	100 buste
NB14439	Fascette in nylon FSC-B 360x4,8 mm bianche	360	4,8	100 pz	75 buste
NB14442	Fascette in nylon FSC-B 430x4,8 mm bianche	430	4,8	100 pz	50 buste
NB14445	Fascette in nylon FSC-B 530x4,8 mm bianche	530	4,8	100 pz	30 buste
NB14448	Fascette in nylon FSC-B 200x7,6 mm bianche	200	7,6	100 pz	50 buste
NB14451	Fascette in nylon FSC-B 250x7,6 mm bianche	250	7,6	100 pz	50 buste
NB14454	Fascette in nylon FSC-B 290x7,6 mm bianche	290	7,6	100 pz	50 buste
NB14457	Fascette in nylon FSC-B 360x7,6 mm bianche	360	7,6	100 pz	40 buste
NB14460	Fascette in nylon FSC-B 450x7,6 mm bianche	450	7,6	100 pz	30 buste
NB14463	Fascette in nylon FSC-B 540x7,6 mm bianche	540	7,6	100 pz	20 buste
NB14466	Fascette in nylon FSC-B 530x9,0 mm bianche	530	9,0	100 pz	20 buste
NB14469	Fascette in nylon FSC-B 780x9,0 mm bianche	780	9,0	100 pz	15 buste
NB14472	Fascette in nylon FSC-B 1.500x 9,0 mm bianche	1.500	9,0	100 pz	5 buste
NB14475	Fascette in nylon FSC-B 1.000x12,6 mm bianche	1.000	12,6	50 pz	20 buste

FSC-V - Fascette in nylon verde

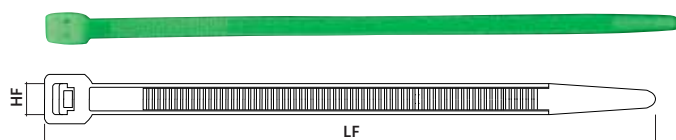

Codice	Descrizione	LF mm	HF mm	Busta singola	Imballo complessivo
NB14630	Fascette in nylon FSC-V 100x2,5 mm verdi	100	2,5	100 pz	50 buste
NB14632	Fascette in nylon FSC-V 140x3,6 mm verdi	140	3,6	100 pz	50 buste
NB14634	Fascette in nylon FSC-V 200x3,6 mm verdi	200	3,6	100 pz	50 buste
NB14636	Fascette in nylon FSC-V 200x4,8 mm verdi	200	4,8	100 pz	50 buste
NB14637	Fascette in nylon FSC-V 290x4,8 mm verdi	290	4,8	100 pz	50 buste

FASCETTE IN NYLON

FSC-G - Fascette in nylon giallo



Codice	Descrizione	LF mm	HF mm	Busta singola	Imballo complessivo
NB14580	Fascette in nylon FSC-G 100x2,5 mm gialle	100	2,5	100 pz	50 buste
NB14582	Fascette in nylon FSC-G 140x3,6 mm gialle	140	3,6	100 pz	50 buste
NB14584	Fascette in nylon FSC-G 200x3,6 mm gialle	200	3,6	100 pz	50 buste
NB14586	Fascette in nylon FSC-G 200x4,8 mm gialle	200	4,8	100 pz	50 buste
NB14588	Fascette in nylon FSC-G 290x4,8 mm gialle	290	4,8	100 pz	50 buste

FSC-R - Fascette in nylon Rosso



Codice	Descrizione	LF mm	HF mm	Busta singola	Imballo complessivo
NB14600	Fascette in nylon FSC-R 100x2,5 mm rosse	100	2,5	100 pz	50 buste
NB14602	Fascette in nylon FSC-R 140x3,6 mm rosse	140	3,6	100 pz	50 buste
NB14604	Fascette in nylon FSC-R 200x3,6 mm rosse	200	3,6	100 pz	50 buste
NB14606	Fascette in nylon FSC-R 200x4,8 mm rosse	200	4,8	100 pz	50 buste
NB14608	Fascette in nylon FSC-R 290x4,8 mm rosse	290	4,8	100 pz	50 buste

FSC-BL - Fascette in nylon Blu



Codice	Descrizione	LF mm	HF mm	Busta singola	Imballo complessivo
NB14620	Fascette in nylon FSC-BL 100x2,5 mm blu	100	2,5	100 pz	50 buste
NB14622	Fascette in nylon FSC-BL 140x3,6 mm blu	140	3,6	100 pz	50 buste
NB14624	Fascette in nylon FSC-BL 200x3,6 mm blu	200	3,6	100 pz	50 buste
NB14626	Fascette in nylon FSC-BL 200x4,8 mm blu	200	4,8	100 pz	50 buste
NB14628	Fascette in nylon FSC-BL 290x4,8 mm blu	290	4,8	100 pz	50 buste

FASCETTE IN NYLON

MATERIALI DI SUPPORTO Per cablaggi elettrici

FSC-N - Fascette in nylon Nere

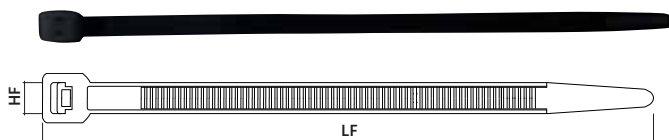

Codice	Descrizione	LF mm	HF mm	Busta singola	Imballo complessivo
NB14500	Fascette in nylon FSC-N 80x2,4 mm nere	80	2,4	100 pz	300 buste
NB14503	Fascette in nylon FSC-N 100x2,5 mm nere	100	2,5	100 pz	300 buste
NB14506	Fascette in nylon FSC-N 140x2,5 mm nere	140	2,5	100 pz	250 buste
NB14509	Fascette in nylon FSC-N 160x2,5 mm nere	160	2,5	100 pz	200 buste
NB14512	Fascette in nylon FSC-N 200x2,5 mm nere	200	2,5	100 pz	200 buste
NB14515	Fascette in nylon FSC-N 140x3,6 mm nere	140	3,6	100 pz	200 buste
NB14518	Fascette in nylon FSC-N 200x3,6 mm nere	200	3,6	100 pz	120 buste
NB14521	Fascette in nylon FSC-N 290x3,6 mm nere	290	3,6	100 pz	120 buste
NB14524	Fascette in nylon FSC-N 360x3,6 mm nere	360	3,6	100 pz	90 buste
NB14527	Fascette in nylon FSC-N 160x4,8 mm nere	160	4,8	100 pz	100 buste
NB14530	Fascette in nylon FSC-N 200x4,8 mm nere	200	4,8	100 pz	100 buste
NB14533	Fascette in nylon FSC-N 250x4,8 mm nere	250	4,8	100 pz	100 buste
NB14536	Fascette in nylon FSC-N 290x4,8 mm nere	290	4,8	100 pz	100 buste
NB14539	Fascette in nylon FSC-N 360x4,8 mm nere	360	4,8	100 pz	75 buste
NB14542	Fascette in nylon FSC-N 430x4,8 mm nere	430	4,8	100 pz	50 buste
NB14545	Fascette in nylon FSC-N 530x4,8 mm nere	530	4,8	100 pz	30 buste
NB14548	Fascette in nylon FSC-N 200x7,6 mm nere	200	7,6	100 pz	50 buste
NB14551	Fascette in nylon FSC-N 250x7,6 mm nere	250	7,6	100 pz	50 buste
NB14554	Fascette in nylon FSC-N 290x7,6 mm nere	290	7,6	100 pz	50 buste
NB14557	Fascette in nylon FSC-N 360x7,6 mm nere	360	7,6	100 pz	40 buste
NB14560	Fascette in nylon FSC-N 450x7,6 mm nere	450	7,6	100 pz	30 buste
NB14563	Fascette in nylon FSC-N 540x7,6 mm nere	540	7,6	100 pz	20 buste
NB14566	Fascette in nylon FSC-N 530x9,0 mm nere	530	9,0	100 pz	20 buste
NB14569	Fascette in nylon FSC-N 780x9,0 mm nere	780	9,0	100 pz	15 buste
NB14572	Fascette in nylon FSC-N 1.500x 9,0 mm nere	1.500	9,0	100 pz	5 buste
NB14575	Fascette in nylon FSC-N 1.000x12,6 mm nere	1.000	12,6	50 pz	20 buste

VTN - Fascette universali per tubi



Codice	Descrizione	H mm	LF mm	HF mm	Busta singola	Imballo complessivo
NB74018	Fascette per tubi VTN 80x2,4 mm Ø tubo 16-32	8	165	2,4	100 pz	5 buste
NB74020	Fascette per tubi VTN 100x2,5 mm Ø tubo 40-63	8	285	2,5	100 pz	-

ACCESSORI PER FASCETTE

MATERIALI DI SUPPORTO Per cablaggi elettrici

BSF - Basetta bidirezionale in ABS con adesivo base gomma per fascette

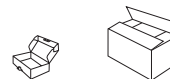
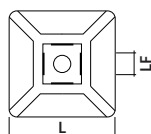

Codice	Descrizione	L mm	LF max mm	Scatola singola	Imballo complessivo
NB15523	Basetta bianca bidirezionale BSF 19x19 mm con adesivo base gomma per fascette	19	3,6	100 pz	10 scatole
NB15527	Basetta bianca bidirezionale BSF 27x27 mm con adesivo base gomma per fascette	27	4,8	100 pz	10 scatole
NB15530	Basetta nera bidirezionale BSF 19x19 mm con adesivo base gomma per fascette	19	3,6	100 pz	10 scatole
NB15534	Basetta nera bidirezionale BSF 27x27 mm con adesivo base gomma per fascette	27	4,8	100 pz	10 scatole

ACCESSORI FISSATUBO

MATERIALI DI SUPPORTO CALCESTRUZZO, PIETRA NATURALE, MATTONE PIENO, MATTONE FORATO, CARTONGESSO

TUBE-FIX - Tassello in nylon per fissaggio di tubi

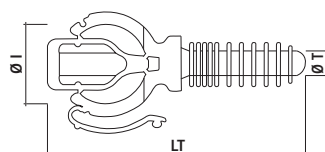
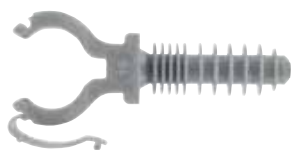

Codice	Descrizione	Ø T mm	LT mm	Ø I mm	Scatola singola	Imballo complessivo
NB87292	Tassello TUBE-FIX in nylon per fissaggio di tubi Ø 16	8	57	16	100 pz	5 scatole
NB87308	Tassello TUBE-FIX in nylon per fissaggio di tubi Ø 20	8	57	20	100 pz	5 scatole
NB87315	Tassello TUBE-FIX in nylon per fissaggio di tubi Ø 22	8	57	22	100 pz	2 scatole

GRAP-FIX - Tassello singolo in nylon per fissaggio di tubi

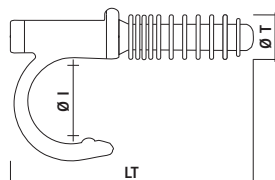

Codice	Descrizione	Ø T mm	LT mm	Ø I mm	Scatola singola	Imballo complessivo
NB87230	Tassello GRAP-FIX in nylon singolo per fissaggio di tubi Ø 16	8	55	16	100 pz	5 scatole
NB87247	Tassello GRAP-FIX in nylon singolo per fissaggio di tubi Ø 20	8	55	20	100 pz	2 scatole
NB87254	Tassello GRAP-FIX in nylon singolo per fissaggio di tubi Ø 25	8	55	25	100 pz	2 scatole

ACCESSORI FISSATUBO

MATERIALI DI SUPPORTO CALCESTRUZZO, PIETRA NATURALE, MATTONE PIENO, MATTONE FORATO, CARTONGESSO

GRAP-FIX - Tassello doppio in nylon per fissaggio di tubi

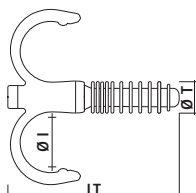

Codice	Descrizione	Ø T mm	LT mm	Ø I mm	Scatola singola	Imballo complessivo
NB87261	Tassello GRAP-FIX in nylon doppio per fissaggio di tubi Ø16	8	55	16	100 pz	2 scatole
NB87278	Tassello GRAP-FIX in nylon doppio per fissaggio di tubi Ø20	8	55	20	100 pz	2 scatole
NB87285	Tassello GRAP-FIX in nylon doppio per fissaggio di tubi Ø25	8	55	25	100 pz	2 scatole

CLIP-FIX - Adattatore in nylon ad espansione per applicazioni su cartongesso

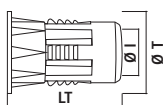

Codice	Descrizione	Ø T mm	Ø I mm	LT mm	Scatola singola	Imballo complessivo
NB87322	Adattatore in nylon CLIP-FIX Ø 12 per TUBE-FIX e GRAP-FIX	12	8	22	100 pz	10 scatole

NFA - Fissatubo aperto in poliammide modulare tra le diverse misure

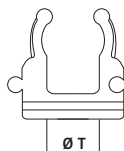

Codice	Descrizione	Ø T mm	Scatola singola
NB74030	Fissatubo aperto NFA 16	16	100 pz
NB74033	Fissatubo aperto NFA 20	20	100 pz
NB74036	Fissatubo aperto NFA 25	25	100 pz
NB74039	Fissatubo aperto NFA 32	32	50 pz
NB74042	Fissatubo aperto NFA 40	40	50 pz
NB74045	Fissatubo aperto NFA 50	50	20 pz

ACCESSORI FISSATUBO

MATERIALI DI SUPPORTO CALCESTRUZZO, PIETRA NATURALE, MATTONE PIENO, MATTONE FORATO, CARTONGESSO

NCF - Fissatubo chiuso in poliammide

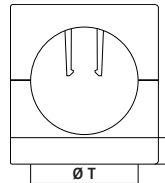

Codice	Descrizione	Ø T mm	Scatola singola
NB74080	Fissatubo chiuso in poliammide NFC 4-8	4-8	200 pz
NB74083	Fissatubo chiuso in poliammide NFC 8-12	8-12	100 pz
NB74086	Fissatubo chiuso in poliammide NFC 12-16	12-16	75 pz
NB74089	Fissatubo chiuso in poliammide NFC 16 -23	16 -23	50 pz
NB74092	Fissatubo chiuso in poliammide NFC 20-25	20-25	50 pz
NB74095	Fissatubo chiuso in poliammide NFC 25-32	25-32	50 pz
NB74098	Fissatubo chiuso in poliammide NFC 32-40	32-40	20 pz
NB74101	Fissatubo chiuso in poliammide NFC 40-60	40-60	15 pz

Cavallotti per tubi e grondaie



FASCETTE STRINGITUBO

MATERIALI DI SUPPORTO TUBI IDRAULICI E PNEUMATICI

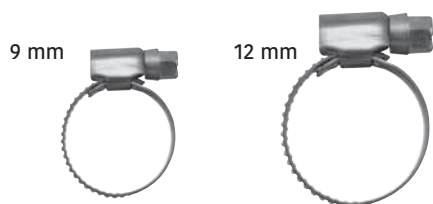

W1

Banda, cassetto e vite in acciaio zincato bianco C15

Coppia di Serraggio - informazioni - Tabella di Conversione
 Newton metres > Kg. force metres: 1 Nm = 0,102 kg m
 Kg. force metres > Newton metres: 1 kg m = 9,81 Nm

FBP W1 - Fascette stringitubo in acciaio



9 MM



Codice	Descrizione	Ø Misura mm	Coppia Serraggio	Scatola singola
NB25000	Fascette W1 9 mm stringitubo in acciaio FBP 8-12 mm	8-12	3 Nm	100 pz
NB25002	Fascette W1 9 mm stringitubo in acciaio FBP 10-16 mm	10-16	3 Nm	100 pz
NB25004	Fascette W1 9 mm stringitubo in acciaio FBP 12-20 mm	12-20	3 Nm	100 pz
NB25006	Fascette W1 9 mm stringitubo in acciaio FBP 16-25 mm	16-25	3 Nm	100 pz
NB25008	Fascette W1 9 mm stringitubo in acciaio FBP 20-32 mm	20-32	3 Nm	100 pz
NB25010	Fascette W1 9 mm stringitubo in acciaio FBP 25-40 mm	25-40	3 Nm	100 pz
NB25014	Fascette W1 9 mm stringitubo in acciaio FBP 32-50 mm	32-50	3 Nm	50 pz
NB25016	Fascette W1 9 mm stringitubo in acciaio FBP 40-60 mm	40-60	3 Nm	50 pz
NB25018	Fascette W1 9 mm stringitubo in acciaio FBP 50-70 mm	50-70	3 Nm	50 pz
NB25020	Fascette W1 9 mm stringitubo in acciaio FBP 60-80 mm	60-80	3 Nm	50 pz
NB25022	Fascette W1 9 mm stringitubo in acciaio FBP 70-90 mm	70-90	3 Nm	25 pz

12 MM



Codice	Descrizione	Ø Misura mm	Coppia Serraggio	Scatola singola
NB25050	Fascette W1 12 mm stringitubo in acciaio FBP 16-25 mm	16-25	3,5 Nm	100 pz
NB25052	Fascette W1 12 mm stringitubo in acciaio FBP 20-32 mm	20-32	3,5 Nm	100 pz
NB25054	Fascette W1 12 mm stringitubo in acciaio FBP 25-40 mm	25-40	3,5 Nm	100 pz
NB25058	Fascette W1 12 mm stringitubo in acciaio FBP 32-50 mm	32-50	3,5 Nm	50 pz
NB25060	Fascette W1 12 mm stringitubo in acciaio FBP 40-60 mm	40-60	3,5 Nm	50 pz
NB25062	Fascette W1 12 mm stringitubo in acciaio FBP 50-70 mm	50-70	3,5 Nm	50 pz
NB25064	Fascette W1 12 mm stringitubo in acciaio FBP 60-80 mm	60-80	3,5 Nm	50 pz
NB25066	Fascette W1 12 mm stringitubo in acciaio FBP 70-90 mm	70-90	3,5 Nm	25 pz
NB25068	Fascette W1 12 mm stringitubo in acciaio FBP 80-100 mm	80-100	3,5 Nm	25 pz
NB25070	Fascette W1 12 mm stringitubo in acciaio FBP 90-110 mm	90-110	3,5 Nm	25 pz
NB25072	Fascette W1 12 mm stringitubo in acciaio FBP100-120 mm	100-120	3,5 Nm	25 pz
NB25074	Fascette W1 12 mm stringitubo in acciaio FBP 110-130 mm	110-130	3,5 Nm	25 pz
NB25076	Fascette W1 12 mm stringitubo in acciaio FBP 120-140 mm	120-140	3,5 Nm	25 pz
NB25078	Fascette W1 12 mm stringitubo in acciaio FBP 130-150 mm	130-150	3,5 Nm	25 pz
NB25080	Fascette W1 12 mm stringitubo in acciaio FBP 140-160 mm	140-160	3,5 Nm	25 pz
NB25082	Fascette W1 12 mm stringitubo in acciaio FBP 150-170 mm	150-170	3,5 Nm	25 pz
NB25084	Fascette W1 12 mm stringitubo in acciaio FBP 160-180 mm	160-180	3,5 Nm	25 pz
NB25086	Fascette W1 12 mm stringitubo in acciaio FBP 170-190 mm	170-190	3,5 Nm	25 pz
NB25088	Fascette W1 12 mm stringitubo in acciaio FBP 180-200 mm	180-200	3,5 Nm	25 pz
NB25090	Fascette W1 12 mm stringitubo in acciaio FBP 200-220 mm	200-220	3,5 Nm	25 pz
NB25092	Fascette W1 12 mm stringitubo in acciaio FBP 210-230 mm	210-230	3,5 Nm	25 pz
NB25094	Fascette W1 12 mm stringitubo in acciaio FBP 230-250 mm	230-250	3,5 Nm	25 pz

FASCETTE STRINGITUBO

MATERIALI DI SUPPORTO TUBI IDRAULICI E PNEUMATICI

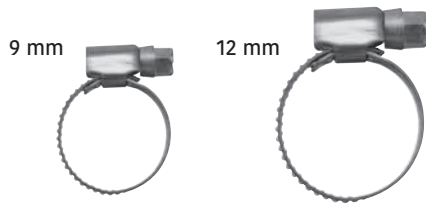

W2

Banda e cassetto in acciaio Inox 430, vite in acciaio zincato bianco C15 (esente cromo VI)

Coppia di Serraggio - informazioni - Tabella di Conversione
 Newton metres > Kg. force metres: 1 Nm = 0,102 kg m
 Kg. force metres > Newton metres: 1 kg m = 9,81 Nm

FBP W2 - Fascette stringitubo in acciaio



9 MM

Codice	Descrizione	Ø Misura mm	Coppia Serraggio	Scatola singola
NB25100	Fascette W2 9 mm stringitubo in acciaio 8-12 mm	8-12	3 Nm	100 pz
NB25102	Fascette W2 9 mm stringitubo in acciaio 10-16 mm	10-16	3 Nm	100 pz
NB25104	Fascette W2 9 mm stringitubo in acciaio 12-22 mm	12-22	3 Nm	100 pz
NB25106	Fascette W2 9 mm stringitubo in acciaio 16-25 mm	16-25	3 Nm	100 pz
NB25108	Fascette W2 9 mm stringitubo in acciaio 20-32 mm	20-32	3 Nm	100 pz
NB25110	Fascette W2 9 mm stringitubo in acciaio 25-40 mm	25-40	3 Nm	100 pz
NB25112	Fascette W2 9 mm stringitubo in acciaio 32-50 mm	32-50	3 Nm	50 pz
NB25114	Fascette W2 9 mm stringitubo in acciaio 40-60 mm	40-60	3 Nm	50 pz
NB25116	Fascette W2 9 mm stringitubo in acciaio 50-70 mm	50-70	3 Nm	50 pz
NB25118	Fascette W2 9 mm stringitubo in acciaio 60-80 mm	60-80	3 Nm	50 pz

12 MM



Codice	Descrizione	Ø Misura mm	Coppia Serraggio	Scatola singola
NB25150	Fascette W2 12 mm stringitubo in acciaio FBP 16-25 mm	16-25	5 Nm	100 pz
NB25152	Fascette W2 12 mm stringitubo in acciaio FBP 20-32 mm	20-32	5 Nm	100 pz
NB25154	Fascette W2 12 mm stringitubo in acciaio FBP 25-40 mm	25-40	5 Nm	100 pz
NB25156	Fascette W2 12 mm stringitubo in acciaio FBP 32-50 mm	32-50	5 Nm	50 pz
NB25158	Fascette W2 12 mm stringitubo in acciaio FBP 40-60 mm	40-60	5 Nm	50 pz
NB25160	Fascette W2 12 mm stringitubo in acciaio FBP 50-70 mm	50-70	5 Nm	50 pz
NB25162	Fascette W2 12 mm stringitubo in acciaio FBP 60-80 mm	60-80	5 Nm	50 pz
NB25164	Fascette W2 12 mm stringitubo in acciaio FBP 70-90 mm	70-90	5 Nm	25 pz
NB25166	Fascette W2 12 mm stringitubo in acciaio FBP 80-100 mm	80-100	5 Nm	25 pz
NB25168	Fascette W2 12 mm stringitubo in acciaio FBP 90-110 mm	90-110	5 Nm	25 pz
NB25170	Fascette W2 12 mm stringitubo in acciaio FBP 100-120 mm	100-120	5 Nm	25 pz
NB25172	Fascette W2 12 mm stringitubo in acciaio FBP 110-130 mm	110-130	5 Nm	25 pz
NB25174	Fascette W2 12 mm stringitubo in acciaio FBP 120-140 mm	120-140	5 Nm	25 pz
NB25176	Fascette W2 12 mm stringitubo in acciaio FBP 130-150 mm	130-150	5 Nm	25 pz
NB25178	Fascette W2 12 mm stringitubo in acciaio FBP 140-160 mm	140-160	5 Nm	25 pz
NB25180	Fascette W2 12 mm stringitubo in acciaio FBP 150-170 mm	150-170	5 Nm	25 pz
NB25182	Fascette W2 12 mm stringitubo in acciaio FBP 160-180 mm	160-180	5 Nm	25 pz
NB25184	Fascette W2 12 mm stringitubo in acciaio FBP 170-190 mm	170-190	5 Nm	25 pz
NB25186	Fascette W2 12 mm stringitubo in acciaio FBP 180-200 mm	180-200	5 Nm	25 pz

FASCETTE STRINGITUBO

MATERIALI DI SUPPORTO TUBI IDRAULICI E PNEUMATICI

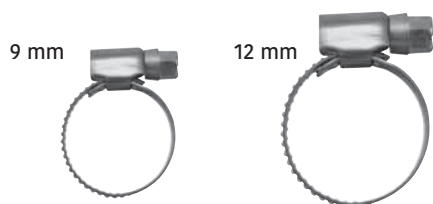

W4

Banda, cassetto e vite in acciaio inox 304

Coppia di Serraggio - informazioni - Tabella di Conversione

Newton metres > Kg. force metres: 1 Nm = 0,102 kg m

Kg. force metres > Newton metres: 1 kg m = 9,81 Nm

FBP W4 - Fascette stringitubo in acciaio



9 MM



Codice	Descrizione	Ø Misura mm	Coppia Serraggio	Scatola singola
NB25200	Fascette W4 9 mm stringitubo in acciaio FBP 8-12 mm	8-12	3 Nm	100 pz
NB25202	Fascette W4 9 mm stringitubo in acciaio FBP 10-16 mm	10-16	3 Nm	100 pz
NB25204	Fascette W4 9 mm stringitubo in acciaio FBP 12-20 mm	12-20	3 Nm	100 pz
NB25206	Fascette W4 9 mm stringitubo in acciaio FBP 16-25 mm	16-25	3 Nm	100 pz
NB25208	Fascette W4 9 mm stringitubo in acciaio FBP 20-32 mm	20-32	3 Nm	100 pz
NB25210	Fascette W4 9 mm stringitubo in acciaio FBP 25-40 mm	25-40	3 Nm	100 pz
NB25212	Fascette W4 9 mm stringitubo in acciaio FBP 32-50 mm	32-50	3 Nm	50 pz
NB25214	Fascette W4 9 mm stringitubo in acciaio FBP 40-60 mm	40-60	3 Nm	50 pz
NB25216	Fascette W4 9 mm stringitubo in acciaio FBP 50-70 mm	50-70	3 Nm	50 pz

12 MM



Codice	Descrizione	Ø Misura mm	Coppia Serraggio	Scatola singola
NB25260	Fascette W4 12 mm stringitubo in acciaio FBP 16-25 mm	16-25	5 Nm	100 pz
NB25262	Fascette W4 12 mm stringitubo in acciaio FBP 20-32 mm	20-32	5 Nm	100 pz
NB25264	Fascette W4 12 mm stringitubo in acciaio FBP 25-40 mm	25-40	5 Nm	100 pz
NB25266	Fascette W4 12 mm stringitubo in acciaio FBP 32-50 mm	32-50	5 Nm	50 pz
NB25268	Fascette W4 12 mm stringitubo in acciaio FBP 40-60 mm	40-60	5 Nm	50 pz
NB25270	Fascette W4 12 mm stringitubo in acciaio FBP 50-70 mm	50-70	5 Nm	50 pz
NB25272	Fascette W4 12 mm stringitubo in acciaio FBP 60-80 mm	60-80	5 Nm	50 pz
NB25274	Fascette W4 12 mm i stringitubo n acciaio FBP 70-90 mm	70-90	5 Nm	25 pz
NB25276	Fascette W4 12 mm stringitubo in acciaio FBP 80-100 mm	80-100	5 Nm	25 pz
NB25278	Fascette W4 12 mm stringitubo in acciaio FBP 90-110 mm	90-110	5 Nm	25 pz
NB25280	Fascette W4 12 mm stringitubo in acciaio FBP 100-120 mm	100-120	5 Nm	25 pz
NB25282	Fascette W4 12 mm stringitubo in acciaio FBP 110-130 mm	110-130	5 Nm	25 pz
NB25284	Fascette W4 12 mm stringitubo in acciaio FBP 120-140 mm	120-140	5 Nm	25 pz
NB25286	Fascette W4 12 mm stringitubo in acciaio FBP 130-150 mm	130-150	5 Nm	25 pz
NB25290	Fascette W4 12 mm stringitubo in acciaio FBP 140-160 mm	140-160	5 Nm	25 pz
NB25292	Fascette W4 12 mm stringitubo in acciaio FBP 150-170 mm	150-170	5 Nm	25 pz
NB25294	Fascette W4 12 mm stringitubo in acciaio FBP 160-180 mm	160-180	5 Nm	25 pz
NB25296	Fascette W4 12 mm stringitubo in acciaio FBP 170-190 mm	170-190	5 Nm	25 pz
NB25298	Fascette W4 12 mm stringitubo in acciaio FBP180-200 mm	180-200	5 Nm	25 pz

FASCETTE STRINGITUBO

MATERIALI DI SUPPORTO TUBI IDRAULICI E PNEUMATICI

FM MT - Rotolo fascetta metrica stringitubo W2 e W4



9 MM



Codice	Descrizione	Banda mm	Scatola singola
NB25540	Rotolo da 30m fascetta metrica W2 9 mm	9	10 pz
NB25545	Rotolo da 30m fascetta metrica W4 9 mm	9	10 pz

FBP - MT - Carrello per fascetta metrica W2 e W4 stringitubo



9 MM



Codice	Descrizione	Banda mm	Scatola singola
NB25542	Carrello per fascetta metrica W2	-	100 pz
NB25547	Carrello per fascetta metrica W4	-	100 pz

FBP-CF C7 - Stringi fascette metriche



Codice	Descrizione	Scatola singola
NB80500	Stringi fascette metriche FBP-CF C7	1 pz

RONDELLE

RPZ - Rondelle in acciaio

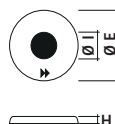

Indicate per tasselli

Codice	Descrizione	Ø I mm	Ø E mm	H mm	Scatola singola
NB16391	Rondelle in acciaio RPZ 6x16x1,5 mm	6	16	1,5	200 pz
NB16407	Rondelle in acciaio RPZ 8x20x2,3 mm	8	20	2,3	200 pz
NB16409	Rondelle in acciaio RPZ 8x24x2 mm	8	24	2	200 pz
NB16414	Rondelle in acciaio RPZ 10x24x2,3 mm	10	24	2,3	200 pz
NB16421	Rondelle in acciaio RPZ 12x27x3 mm	12	27	3	200 pz
NB102148	Rondelle in acciaio RPZ 12x36x2,5 mm	12	36	2,5	200 pz
NB16424	Rondelle in acciaio RPZ 14x42x3 mm	14	42	3	200 pz
NB16427	Rondelle in acciaio RPZ 16x48x3 mm	16	48	3	200 pz
NB16430	Rondelle in acciaio Nobex RPZ 18x54x3 mm	18	54	3	200 pz

ROND-IX INOX - Rondelle in acciaio inox A2 IN 9021 UNI 6593 B

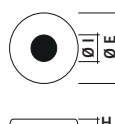

Codice	Descrizione	Ø I mm	Ø E mm	Scatola singola
NB30397	Rondelle in acciaio inox ROND-IX 6x18 mm	6	18	200 pz
NB30403	Rondelle in acciaio inox ROND-IX 8x24 mm	8	24	200 pz
NB30427	Rondelle in acciaio inox ROND-IX 10x30 mm	10	30	200 pz
NB30434	Rondelle in acciaio inox ROND-IX 12x37 mm	12	37	200 pz

RQ-I - Rondella quadrata per isolamento

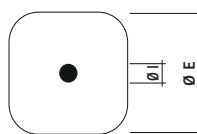

Codice	Descrizione	Ø I mm	L mm	H mm	Scatola singola	Imballo complessivo
NB9676	Rondella quadrata per isolamento RQ-I Ø 5,5	5,5	70	70	200 pz	5 scatole
NB46152	Rondella quadrata per isolamento RQ-I Ø 6,5	6,5	70	70	200 pz	5 scatole
NB46169	Rondella quadrata per isolamento RQ-I Ø 8,0	8,0	70	70	200 pz	5 scatole

BARRE FILETTATE

B-FIL - Barre filettate in acciaio zincato DIN 975

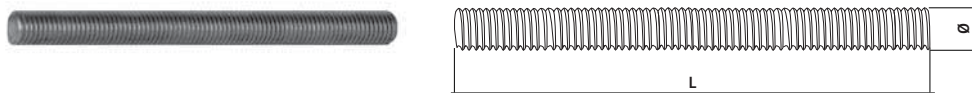

Classe 4.8



Codice	Descrizione	Ø mm	L mm	Scatola singola
NB16018	Barre filettate in acciaio zincato B-FIL 4x1000 mm	4	1000	50 pz
NB16025	Barre filettate in acciaio zincato B-FIL 5x1000 mm	5	1000	50 pz
NB16032	Barre filettate in acciaio zincato B-FIL 6x1000 mm	6	1000	100 pz
NB16049	Barre filettate in acciaio zincato B-FIL 8x1000 mm	8	1000	50 pz
NB16056	Barre filettate in acciaio zincato B-FIL 10x1000 mm	10	1000	25 pz
NB16063	Barre filettate in acciaio zincato B-FIL 12x1000 mm	8	1000	25 pz
NB53587	Barre filettate in acciaio zincato B-FIL 14x1000 mm	14	1000	20 pz
NB16070	Barre filettate in acciaio zincato B-FIL 16x1000 mm	16	1000	10 pz
NB55345	Barre filettate in acciaio zincato B-FIL 18x1000 mm	18	1000	10 pz
NB16087	Barre filettate in acciaio zincato B-FIL 20x1000 mm	20	1000	10 pz
NB55352	Barre filettate in acciaio zincato B-FIL 22x1000 mm	22	1000	8 pz
NB55369	Barre filettate in acciaio zincato B-FIL 24x1000 mm	24	1000	6 pz
NB55376	Barre filettate in acciaio zincato B-FIL 27x1000 mm	27	1000	4 pz
NB55383	Barre filettate in acciaio zincato B-FIL 30x1000 mm	30	1000	5 pz

A richiesta:

- misure speciali da 2, 3 e 5 m
- barre filettate classe 8.8 e in acciaio inox A2

DADO BARILOTTO

BAR-F - Dado esagonale zincato alto con funzione di raccordo per barre filettate

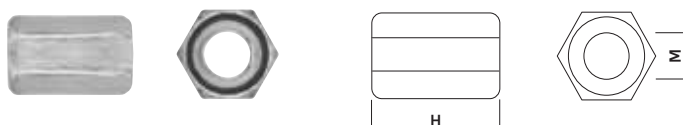

Codice	Descrizione	Passo M	H mm	chiave	Scatola singola
NB16858	Dado esagonale zincato alto BAR-F M 6x30 mm	6	30	10	200 pz
NB16865	Dado esagonale zincato alto BAR-F M 8x30 mm	8	30	13	150 pz
NB16872	Dado esagonale zincato alto BAR-F M 10x30 mm	10	30	17	100 pz
NB16889	Dado esagonale zincato alto BAR-F M 12x30 mm	12	30	19	50 pz

DADI

Viengono utilizzati nel settore edile, industriale, meccanico mediante l'uso di viti passo metrico e rondelle. La versione in acciaio inox A2 viene utilizzato in ambienti aggressivi (industrie chimiche), in zone soggette a condizioni atmosferiche particolari (insalubri, marine, intemperie); luoghi pubblici (ospedali, arredamento urbano, istituzioni); industriali (industrie alimentari, ecc.).

DMZ - DIN 934 UNI 5588

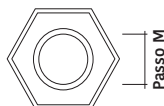

Codice	Descrizione	Passo M	Scatola singola
NB16230	Dado esagonale in acciaio DMZ M4	4	200 pz
NB16247	Dado esagonale in acciaio DMZ M5	5	200 pz
NB16254	Dado esagonale in acciaio DMZ M6	6	200 pz
NB16261	Dado esagonale in acciaio DMZ M8	8	200 pz
NB16278	Dado esagonale in acciaio DMZ M10	10	200 pz
NB16285	Dado esagonale in acciaio DMZ M12	12	200 pz
NB16290	Dado esagonale in acciaio DMZ M14	14	200 pz
NB16292	Dado esagonale in acciaio DMZ M16	16	200 pz
NB16294	Dado esagonale in acciaio DMZ M18	18	200 pz
NB16308	Dado esagonale in acciaio DMZ M20	20	200 pz

DMX A2 - Dado esagonale in acciaio inox A2 DIN 934 UNI 5588

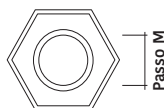

Codice	Descrizione	Passo M	Scatola singola
NB16315	Dado esagonale in acciaio inox A2 DMX M 4	4	200 pz
NB16322	Dado esagonale in acciaio inox A2 DMX M 5	5	200 pz
NB16339	Dado esagonale in acciaio inox A2 DMX M 6	6	200 pz
NB16346	Dado esagonale in acciaio inox A2 DMX M 8	8	200 pz
NB16353	Dado esagonale in acciaio inox A2 DMX M 10	10	200 pz
NB16360	Dado esagonale in acciaio inox A2 DMX M 12	12	200 pz
NB16377	Dado esagonale in acciaio inox A2 DMX M 16	16	200 pz
NB16384	Dado esagonale in acciaio inox A2 DMX M 20	20	200 pz

DA-Z - Dado esagonale con autobloccante IN 985 UNI 7474



Codice	Descrizione	Passo M	Scatola singola
NB63692	Dado esagonale in acciaio con autobloccante DA-Z M 6	6	100 pz
NB63708	Dado esagonale in acciaio con autobloccante DA-Z M 8	6	100 pz
NB63715	Dado esagonale in acciaio con autobloccante DA-Z M 10	10	100 pz
NB63722	Dado esagonale in acciaio con autobloccante DA-X M 6 INOX (a richiesta)	6	100 pz

ACCESSORI VITE TRUCIOLARE

Vite truciolare universale, zincata bianca con testa svasata e impronta Pozidrive idonea in abbinamento con tasselli in nylon.

VITE TSP - Con impronta PZ DIN 7505/A. zincata bianca

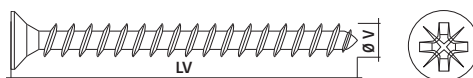

Codice	Descrizione	Ø V mm	LV mm	Impronta Pz	Scatola singola
NB16940	Vite TSP 3,0x12 con impronta Pozidrive	3	12	1	1.000 pz
NB16957	Vite TSP 3,0x16 con impronta Pozidrive	3	16	1	1.000 pz
NB16964	Vite TSP 3,0x18 con impronta Pozidrive	3	18	1	1.000 pz
NB16971	Vite TSP 3,0x20 con impronta Pozidrive	3	20	1	1.000 pz
NB16995	Vite TSP 3,0x30 con impronta Pozidrive	3	30	1	500 pz
NB17015	Vite TSP 3,0x40 con impronta Pozidrive	3	40	1	500 pz
NB17022	Vite TSP 3,5x12 con impronta Pozidrive	3,5	12	2	1.000 pz
NB17039	Vite TSP 3,5x16 con impronta Pozidrive	3,5	16	2	1.000 pz
NB17053	Vite TSP 3,5x20 con impronta Pozidrive	3,5	20	2	1.000 pz
NB17060	Vite TSP 3,5x25 con impronta Pozidrive	3,5	25	2	500 pz
NB17084	Vite TSP 3,5x35 con impronta Pozidrive	3,5	35	2	500 pz
NB17091	Vite TSP 3,5x40 con impronta Pozidrive	3,5	40	2	500 pz
NB17107	Vite TSP 3,5x45 con impronta Pozidrive	3,5	45	2	200 pz
NB17114	Vite TSP 3,5x50 con impronta Pozidrive	3,5	50	2	200 pz
NB17121	Vite TSP 4,0x16 con impronta Pozidrive	4	16	2	500 pz
NB17138	Vite TSP 4,0x18 con impronta Pozidrive	4	18	2	500 pz
NB17145	Vite TSP 4,0x20 con impronta Pozidrive	4	20	2	500 pz
NB17152	Vite TSP 4,0x25 con impronta Pozidrive	4	25	2	500 pz
NB17169	Vite TSP 4,0x30 con impronta Pozidrive	4	30	2	500 pz
NB17176	Vite TSP 4,0x35 con impronta Pozidrive	4	35	2	500 pz
NB17183	Vite TSP 4,0x40 con impronta Pozidrive	4	40	2	500 pz
NB17190	Vite TSP 4,0x45 con impronta Pozidrive	4	45	2	200 pz
NB17206	Vite TSP 4,0x50 con impronta Pozidrive	4	50	2	200 pz
NB17213	Vite TSP 4,0x60 con impronta Pozidrive	4	60	2	200 pz
NB17220	Vite TSP 4,5x25 con impronta Pozidrive	4,5	25	2	500 pz
NB17237	Vite TSP 4,5x30 con impronta Pozidrive	4	30	2	500 pz
NB17244	Vite TSP 4,5x35 con impronta Pozidrive	4,5	35	2	200 pz
NB17251	Vite TSP 4,5x40 con impronta Pozidrive	4,5	40	2	200 pz
NB17268	Vite TSP 4,5x45 con impronta Pozidrive	4,5	45	2	200 pz
NB17275	Vite TSP 4,5x50 con impronta Pozidrive	4,5	50	2	200 pz
NB17282	Vite TSP 4,5x60 con impronta Pozidrive	4,5	60	2	200 pz
NB17299	Vite TSP 4,5x70 con impronta Pozidrive	4,5	70	2	200 pz
NB17305	Vite TSP 5,0x20 con impronta Pozidrive	5	20	2	500 pz
NB17312	Vite TSP 5,0x25 con impronta Pozidrive	5	25	2	500 pz
NB17329	Vite TSP 5,0x30 con impronta Pozidrive	5	30	2	200 pz
NB17336	Vite TSP 5,0x35 con impronta Pozidrive	5	35	2	200 pz

ACCESSORI VITE TRUCIOLARE



Codice	Descrizione	Ø V mm	LV mm	Impronta Pz	Scatola singola
NB17343	Vite TSP 5,0x40 con impronta Pozidrive	5	40	2	200 pz
NB17350	Vite TSP 5,0x45 con impronta Pozidrive	5	45	2	200 pz
NB44851	Vite TSP 5,0x50 con impronta Pozidrive	5	50	2	200 pz
NB17374	Vite TSP 5,0x60 con impronta Pozidrive	5	60	2	200 pz
NB17381	Vite TSP 5,0x70 con impronta Pozidrive	5	70	2	200 pz
NB17398	Vite TSP 5,0x80 con impronta Pozidrive	5	80	2	200 pz
NB17404	Vite TSP 5,0x90 con impronta Pozidrive	5	90	2	100 pz
NB17411	Vite TSP 5,0x100 con impronta Pozidrive	5	100	2	100 pz
NB17435	Vite TSP 6,0x50 con impronta Pozidrive	6	50	2	200 pz
NB17442	Vite TSP 6,0x60 con impronta Pozidrive	6	60	3	200 pz
NB17466	Vite TSP 6,0x80 con impronta Pozidrive	6	80	3	200 pz
NB17473	Vite TSP 6,0x90 con impronta Pozidrive	6	90	3	100 pz
NB17480	Vite TSP 6,0x100 con impronta Pozidrive	6	100	3	100 pz
NB17497	Vite TSP 6,0x120 con impronta Pozidrive	6	120	3	100 pz



Confezioni industriali

Codice	Descrizione	Ø V mm	LV mm	Impronta Pz	Scatola singola
NB87117	Bulk vite TSP 4,0x30 con impronta Pozidrive	4	30	2	12.000 pz
NB87124	Bulk vite TSP 4,5x40 con impronta Pozidrive	4,5	40	2	6.000 pz
NB87131	Bulk vite TSP 5,0x45 con impronta Pozidrive	5	45	2	5.000 pz
NB87135	Bulk vite TSP 5,0x50 con impronta Pozidrive	5	50	2	5.000 pz
NB87148	Bulk vite TSP 6,0x60 con impronta Pozidrive	6	60	3	2.000 pz

ACCESSORI PER FISSAGGI E VITERIE

Vengono utilizzati nel settore edile, nelle coperture per l'ancoraggio di lamiera gregate e ondulate, per la posa in opera di tetti in legno e la costruzione di gazebo.

TRF - Tirafondo DIN 571 zincata bianca

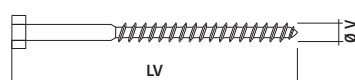

Codice	Descrizione	Ø V mm	LV mm	Impronta CH	Scatola singola
NB36542	Tirafondo TRF 6x45 mm con testa TE	6	45	10	200 pz
NB36545	Tirafondo TRF 6x60 mm con testa TE	6	60	10	200pz
NB36550	Tirafondo TRF 6x80 mm con testa TE	6	80	10	200 pz
NB36559	Tirafondo TRF 7x 60 mm con testa TE	7	60	12	200 pz
NB36566	Tirafondo TRF 7x 80 mm con testa TE	7	80	12	200 pz
NB36573	Tirafondo TRF 7x100 mm con testa TE	7	100	12	200 pz
NB36580	Tirafondo TRF 7x120 mm con testa TE	7	120	12	200 pz
NB36597	Tirafondo TRF 7x140 mm con testa TE	7	140	12	200 pz
NB53693	Tirafondo TRF 7x165 mm con testa TE	7	165	12	200 pz
NB36610	Tirafondo TRF 7x205 mm con testa TE	7	205	12	200 pz
NB87900	Tirafondo TRF 8x60 mm con testa TE	8	60	13	100 pz
NB87902	Tirafondo TRF 8x70 mm con testa TE	8	70	13	100 pz
NB87919	Tirafondo TRF 8x80 mm con testa TE	8	80	13	100 pz
NB87933	Tirafondo TRF 8x100 mm con testa TE	8	100	13	100 pz
NB36639	Tirafondo TRF 10x60 mm con testa TE	10	60	17	50 pz
NB36641	Tirafondo TRF 10x80 mm con testa TE	10	80	17	50 pz
NB87940	Tirafondo TRF 10x90 mm con testa TE	10	90	17	50 pz
NB87957	Tirafondo TRF 10x100 mm con testa TE	10	100	17	50 pz
NB41683	Tirafondo TRF 10x130 mm con testa TE	10	130	17	50 pz
NB51941	Tirafondo TRF 10x160 mm con testa TE	10	160	17	50 pz
NB53921	Tirafondo TRF 10x200 mm con testa TE	10	200	17	25 pz
NB51958	Tirafondo TRF 10x240 mm con testa TE	10	240	17	25 pz
NB99349	Tirafondo TRF 12x80mm con testa TE	12	80	19	50 pz
NB36658	Tirafondo TRF 12x90 mm con testa TE	12	90	19	50 pz
NB36672	Tirafondo TRF 12x140 mm con testa TE	12	140	19	50 pz
NB36689	Tirafondo TRF 12x160 mm con testa TE	12	160	19	50 pz
NB36696	Tirafondo TRF 12x200 mm con testa TE	12	200	19	50 pz
NB36702	Tirafondo TRF 12x240 mm con testa TE	12	240	19	50 pz

ACCESSORI PER FISSAGGI E VITERIE

Vite truciolare autosvasante con impronta Torx (TX) tropicalizzata con alette sottotesta che evitano lo sfaldamento e le fenditure nella struttura di supporto e ne facilitano la posa in opera. L'elica alesatrice lungo il gambo ha la funzione di facilitare l'inserimento tramite una riduzione dell'attrito e di favorire la penetrazione della parte liscia del gambo priva di filettatura. Viene utilizzata nel settore della carpenteria lignea, costruzione di gazebi, coperture, tetti, ecc.

W - Viti lunghe con zincatura gialla

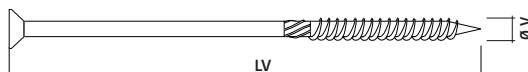

Codice	Descrizione	Ø V mm	LV mm	Impronta TX	Scatola singola
NB74275	Vite lunga con zincatura gialla W-TX 5X50 mm	5	50	-	50 pz
NB74277	Vite lunga con zincatura gialla W-TX 5X60 mm	5	60	-	50 pz
NB74280	Vite lunga con zincatura gialla W-TX 5X80 mm	5	80	-	50 pz
NB74285	Vite lunga con zincatura gialla W-TX 6x80 mm	6	80	T 30	50 pz
NB74292	Vite lunga con zincatura gialla W-TX 6x100 mm	6	100	T 30	50 pz
NB74308	Vite lunga con zincatura gialla W-TX 6x120 mm	6	120	T 30	50 pz
NB74315	Vite lunga con zincatura gialla W-TX 6x140 mm	6	140	T 30	50 pz
NB74322	Vite lunga con zincatura gialla W-TX 6x160 mm	6	160	T 30	50 pz
NB74339	Vite lunga con zincatura gialla W-TX 6x180 mm	6	180	T 30	50 pz
NB74346	Vite lunga con zincatura gialla W-TX 6x200 mm	6	200	T 30	50 pz
NB74353	Vite lunga con zincatura gialla W-TX 6x220 mm	6	220	T 30	50 pz
NB74360	Vite lunga con zincatura gialla W-TX 8x140 mm	8	140	T 40	50 pz
NB74377	Vite lunga con zincatura gialla W-TX 8x160 mm	8	160	T 40	50 pz
NB74384	Vite lunga con zincatura gialla W-TX 8x180 mm	8	180	T 40	50 pz
NB74391	Vite lunga con zincatura gialla W-TX 8x200 mm	8	200	T 40	50 pz
NB74407	Vite lunga con zincatura gialla W-TX 8x220 mm	8	220	T 40	50 pz
NB74414	Vite lunga con zincatura gialla W-TX 8x240 mm	8	240	T 40	50 pz
NB74421	Vite lunga con zincatura gialla W-TX 8x260 mm	8	260	T 40	50 pz
NB74438	Vite lunga con zincatura gialla W-TX 8x280 mm	8	280	T 40	50 pz
NB74445	Vite lunga con zincatura gialla W-TX 8x300 mm	8	300	T 40	50 pz
NB74452	Vite lunga con zincatura gialla W-TX 10x160 mm	10	160	T 40	50 pz
NB74469	Vite lunga con zincatura gialla W-TX 10x180 mm	10	180	T 40	25 pz
NB74476	Vite lunga con zincatura gialla W-TX 10x200 mm	10	200	T 40	50 pz
NB74483	Vite lunga con zincatura gialla W-TX 10x220 mm	10	220	T 40	50 pz
NB74490	Vite lunga con zincatura gialla W-TX 10x240 mm	10	240	T 40	50 pz
NB74506	Vite lunga con zincatura gialla W-TX 10x260 mm	10	260	T 40	50 pz
NB74513	Vite lunga con zincatura gialla W-TX 10x280 mm	10	280	T 40	50 pz
NB74520	Vite lunga con zincatura gialla W-TX 10x300 mm	10	300	T 40	50 pz

RW - Rondelle per viti lunghe



Codice	Descrizione	Ø I mm	Ø E mm	Scatola singola	Imballo complessivo
NB74766	Rondelle per viti lunghe RW 7,6x20 mm	7,6	20	200 pz	5 scatole
NB74773	Rondelle per viti lunghe RW 9,5x25 mm	9,5	25	200 pz	5 scatole
NB74780	Rondelle per viti lunghe RW 11,4x30 mm	11,4	30	200 pz	5 scatole

ACCESSORI PER FISSAGGI E VITERIE

Vite flangiata bombata a testa esagonale stampata e rullata con filetto parziale a legno utilizzata per ancoraggi su legno, lastre truciolati, legno lamellare, pannelli sandwich, lamiere ondulate o gregate.

AUT-LA - Vite autofilettante zincata con punta a chiodo

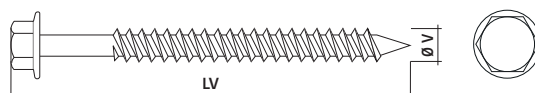

Zincatura bianca. Punta chiodo

Codice	Descrizione	Ø V mm	LV mm	Chiave CH	Scatola singola	Imballo complessivo
NB44974	Vite autofilettante zincata con punta a chiodo AUT-LA 6,3x20mm	6,3	20	10	200 pz	10 scatole
NB44981	Vite autofilettante zincata con punta a chiodo AUT-LA 6,3x25mm	6,3	25	10	200 pz	10 scatole
NB44998	Vite autofilettante zincata con punta a chiodo AUT-LA 6,3x35mm	6,3	35	10	200 pz	5 scatole
NB38584	Vite autofilettante zincata con punta a chiodo AUT-LA 6,3x40mm	6,3	40	10	200 pz	5 scatole
NB45001	Vite autofilettante zincata con punta a chiodo AUT-LA 6,3x50mm	6,3	50	10	200 pz	5 scatole
NB45018	Vite autofilettante zincata con punta a chiodo AUT-LA 6,3x60mm	6,3	60	10	100 pz	5 scatole
NB45025	Vite autofilettante zincata con punta a chiodo AUT-LA 6,3x65mm	6,3	65	10	100 pz	5 scatole
NB45032	Vite autofilettante zincata con punta a chiodo AUT-LA 6,3x70mm	6,3	70	10	100 pz	5 scatole
NB45049	Vite autofilettante zincata con punta a chiodo AUT-LA 6,3x80mm	6,3	80	10	100 pz	5 scatole
NB45056	Vite autofilettante zincata con punta a chiodo AUT-LA 6,3x90mm	6,3	90	10	100 pz	5 scatole
NB45063	Vite autofilettante zincata con punta a chiodo AUT-LA 6,3x100mm	6,3	100	10	100 pz	5 scatole
NB45070	Vite autofilettante zincata con punta a chiodo AUT-LA 6,3x110mm	6,3	110	10	100 pz	5 scatole
NB45087	Vite autofilettante zincata con punta a chiodo AUT-LA 6,3x120mm	6,3	120	10	100 pz	5 scatole
NB45094	Vite autofilettante zincata con punta a chiodo AUT-LA 6,3x130mm	6,3	130	10	100 pz	5 scatole
NB45100	Vite autofilettante zincata con punta a chiodo AUT-LA 6,3x150mm	6,3	150	10	100 pz	5 scatole
NB45117	Vite autofilettante zincata con punta a chiodo AUT-LA 6,3x180mm	6,3	180	10	100 pz	5 scatole

PERF-LA - Vite autoforante su lamiere con spessori da 1 a 5 mm con punta trapano

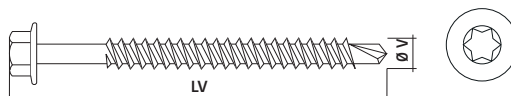

Zincatura bianca. Punta trapano

Codice	Descrizione	Ø V mm	LV mm	Chiave CH	Scatola singola	Imballo complessivo
NB45216	Vite autoforante su lamiera PERF-LA 6,3x20 con punta trapano	6,3	20	10	200 pz	10 scatole
NB45223	Vite autoforante su lamiera PERF-LA 6,3x25 con punta trapano	6,3	25	10	200 pz	10 scatole
NB45230	Vite autoforante su lamiera PERF-LA 6,3x35 con punta trapano	6,3	35	10	200 pz	5 scatole
NB45247	Vite autoforante su lamiera PERF-LA 6,3x40 con punta trapano	6,3	40	10	200 pz	5 scatole
NB45254	Vite autoforante su lamiera PERF-LA 6,3x50 con punta trapano	6,3	50	10	200 pz	5 scatole
NB45261	Vite autoforante su lamiera PERF-LA 6,3x60 con punta trapano	6,3	60	10	100 pz	5 scatole
NB45278	Vite autoforante su lamiera PERF-LA 6,3x70 con punta trapano	6,3	70	10	100 pz	5 scatole
NB45285	Vite autoforante su lamiera PERF-LA 6,3x 80 con punta trapano	6,3	80	10	100 pz	5 scatole
NB45292	Vite autoforante su lamiera PERF-LA 6,3x100 con punta trapano	6,3	100	10	100 pz	5 scatole
NB38591	Vite autoforante su lamiera PERF-LA 6,3x120 con punta trapano	6,3	120	10	100 pz	5 scatole
NB45300	Vite autoforante su lamiera PERF-LA 6,3x130 con punta trapano	6,3	130	10	100 pz	5 scatole

ACCESSORI PER FISSAGGI E VITERIE

GUA-RC - Guarnizione romboidali catramate lato 35x35

Codice	Descrizione	Ø mm	L mm	Scatola singola	Imballo complessivo
NB38843	Guarnizione romboidali GUA-RC 35x35 mm	35	35	200 pz	5 scatole

ROND-RM/PLA - Rondelle romboidali in plastica

Codice	Descrizione	Ø mm	L mm	Scatola singola	Imballo complessivo
NB44101	Rondella romboidale in plastica ROND-RM/PLA 27x27 mm	27	27	100 pz	5 scatole
NB44103	Rondella romboidale in plastica ROND-RM/PLA 30x30 mm	30	30	200 pz	10 scatole

ROND-RM/LA - Rondelle romboidali in lamiera zincata per coperture

Codice	Descrizione	Ø mm	L mm	Scatola singola	Imballo complessivo
NB38898	Rondella romboidale in lamiera zincata ROND-RM/LA 27x27 mm	27	27	200 pz	10 scatole
NB38904	Rondella romboidale in lamiera zincata ROND-RM/LA 30x30 mm	30	30	200 pz	10 scatole
NB38911	Rondella romboidale in lamiera zincata ROND-RM/LA 35x35 mm	35	35	200 pz	5 scatole
NB38928	Rondella romboidale in lamiera zincata ROND-RM/LA 40x40 mm	40	40	200 pz	5 scatole

ACCESSORI PER FISSAGGI E VITERIE

BR - Barrette zincate per coperture

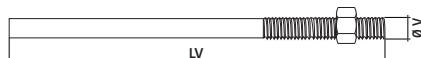

Codice	Descrizione	Ø V mm	LV mm	Scatola singola
NB44202	Barrette zincate per coperture BR 100 mm	6	100	200 pz
NB44219	Barrette zincate per coperture BR 150 mm	6	150	200 pz
NB44226	Barrette zincate per coperture BR 200 mm	6	200	200 pz
NB44233	Barrette zincate per coperture BR 250 mm	6	250	200 pz
NB44240	Barrette zincate per coperture BR 300 mm	6	300	200 pz
NB44257	Barrette zincate per coperture BR 400 mm	6	400	200 pz

VFX - Viti per fotovoltaico inox A2

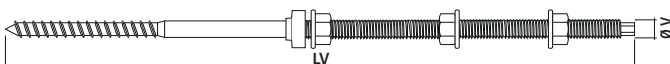

Articoli a richiesta

Codice	Descrizione	Ø V mm	LV mm	Scatola singola	Imballo complessivo
NB90808150	Vite doppio filetto per fotovoltaico 8x150 mm	8	150	50 pz	5 scatole
NB90808200	Vite doppio filetto per fotovoltaico 8x200 mm	8	200	25 pz	5 scatole
NB91010160	Vite doppio filetto per fotovoltaico 10x160 mm	10	160	25 pz	5 scatole
NB91010200	Vite doppio filetto per fotovoltaico 10x200mm	10	200	25 pz	5 scatole
NB91010250	Vite doppio filetto per fotovoltaico 10x250 mm	10	250	20 pz	5 scatole
NB91010300	Vite doppio filetto per fotovoltaico 10x300 mm	10	300	20 pz	5 scatole
NB91212200	Vite doppio filetto per fotovoltaico 12x200 mm	12	200	20 pz	5 scatole
NB91212250	Vite doppio filetto per fotovoltaico 12x250 mm	12	250	20 pz	5 scatole
NB91212300	Vite doppio filetto per fotovoltaico 12x300 mm	12	300	15 pz	5 scatole
NB91212350	Vite doppio filetto per fotovoltaico 12x350 mm	12	350	15 pz	5 scatole
NB91212400	Vite doppio filetto per fotovoltaico 12x400 mm	12	400	15 pz	5 scatole

BR-AP - Appendi pensili spessore 1,2 mm altezza 50 mm



Codice	Descrizione	L mm	SP mm	H mm	Scatola singola	Imballo complessivo
NB30021	Appendi pensili BR-AP 2000x50 mm spessore 1,2 mm	2000	1,2	50	1 pz	10 scatole

ACCESSORI PER COPERTURE

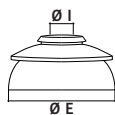
ROND-CA - Rondelle inox con cappello a tenuta stagna per viti

Codice	Descrizione	Ø I mm	Ø E mm	Scatola singola	Imballo complessivo
NB35125	Rondelle inox con cappello ROND-CA Ø 25 mm nera	6	25	200 pz	5 scatole
NB35126	Rondelle inox con cappello ROND-CA Ø 25 mm testa di moro	6	25	200 pz	5 scatole

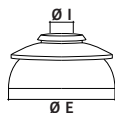
ROND-CB - Rondella Inox verniciata con cappello a tenuta stagna per viti

Codice	Descrizione	Colore	Ø I mm	Ø E mm	Scatola singola
NB35110	Rondelle inox con cappello ROND-CB Ø 25 alluminio		6	25	200 pz
NB35111	Rondelle inox con cappello ROND-CB Ø 25 bianco grigio	RAL 9002	6	25	200 pz
NB35112	Rondelle inox con cappello ROND-CB Ø 25 rosso ossido	RAL 3009	6	25	200 pz
NB35113	Rondelle inox con cappello ROND-CB Ø 25 rosso mattone	RAL 8004	6	25	200 pz

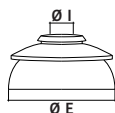
ROND-CV - Rondelle coniche vulcanizzate in acciaio pre-zincato per viti autoforanti nelle coperture

Codice	Descrizione	Ø I mm	Ø E mm	Scatola singola	Imballo complessivo
NB35132	Rondelle coniche vulcanizzate ROND-CV Ø 14 mm	5,1	14	500 pz	5 scatole
NB35149	Rondelle coniche vulcanizzate ROND-CV Ø 16 mm	6,7	16	500 pz	5 scatole
NB35156	Rondelle coniche vulcanizzate ROND-CV Ø 19 mm	6,7	19	500 pz	5 scatole
NB35163	Rondelle coniche vulcanizzate ROND-CV Ø 22 mm	6,7	22	500 pz	5 scatole
NB35170	Rondelle coniche vulcanizzate ROND-CV Ø 29 mm	6,7	29	500 pz	5 scatole

ACCESSORI PER COPERTURE

CPL - Cappellotti in acciaio con guarnizione a tenuta stagna



Codice	Descrizione	Colore	HC mm	LC mm	Scatola singola
NB38600	Cappello in acciaio zincato CPL 20x36 mm alluminio		20	36	500 pz
NB38610	Cappello verniciato CPL 20x36 mm bianco grigio	RAL 9002	20	36	500 pz
NB38611	Cappello verniciato CPL 20x36 mm marrone cioccolato	RAL 8017	20	36	500 pz
NB38612	Cappello verniciato CPL 20x36 mm rosso ossido	RAL 3009	20	36	500 pz
NB38613	Cappello verniciato CPL 20x36 mm rosso mattone	RAL 8004	20	36	500 pz
NB38700	Cappellotti in acciaio zincato CPL 25x34 mm alluminio		25	34	500 pz
NB38710	Cappello verniciato CPL 25x34 mm bianco grigio	RAL 9002	25	34	500 pz
NB38711	Cappello verniciato CPL 25x34 mm marrone cioccolato	RAL 8017	25	34	500 pz
NB38712	Cappello verniciato CPL 25x34 mm rosso mattone	RAL 8004	25	34	500 pz
NB38800	Cappellotti in acciaio zincato CPL 30x38 mm alluminio		30	38	500 pz
NB38810	Cappello verniciato CPL 30x38 mm bianco grigio	RAL 9002	30	38	500 pz
NB38811	Cappello verniciato CPL 30x38 mm marrone cioccolato	RAL 8017	30	38	500 pz
NB38812	Cappello verniciato CPL 30x38 mm rosso ossido	RAL 3009	30	38	500 pz
NB38113	Cappello verniciato CPL 30x38 mm rosso mattone	RAL 8004	30	38	500 pz

ROND-PVC - Rondella in pvc trasparente per coperture



Codice	Descrizione	Ø I mm	Ø E mm	Scatola singola
NB44066	Rondella in pvc trasparente ROND-PVC 6x15 mm per coperture	6	15	500 pz

ROND-LP - Rondelle con tappo coprivite e guarnizione isolante per il fissaggio di lastre in PVC

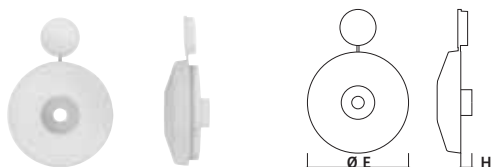

Idonee per il fissaggio di lastre in PVC su strutture lignee e metallo per coperture curve, strutture industriali, impianti sportivi, pensiline, serre, passerelle pedonali

Codice	Descrizione	Ø mm	H mm	Scatola singola	Imballo complessivo
NB63810	Rondelle con tappo coprivite e guarnizione isolante ROND-LP Ø 50 H 0/2 mm	50	0/2	50 pz	2 scatole
NB63814	Rondelle con tappo coprivite e guarnizione isolante ROND-LP Ø 50 H 6 mm	50	6	50 pz	2 scatole
NB53471	Rondelle con tappo coprivite e guarnizione isolante ROND-LP Ø 50 H 10 mm	50	10	50 pz	2 scatole
NB53396	Rondelle con tappo coprivite e guarnizione isolante ROND-LP Ø 50 H 16 mm	50	16	50 pz	2 scatole

FISSAGGI CHIMICI

FISSAGGI CHIMICI

NCE	140
NCE PLUS	140
NCF	141
NCS	141
NCX	142
PST-NCX	142
MIXER PER NCX	142
PST-RB	143
PST-RP	143
PST-BT	143
MIXER	143
AM	144
SCO	144
ALB	145
GN - GDN	145
GM	145
VCG	146
BR	146
OC	147
GA	147
NS-A	148
NS-N	148
NS-AS	149
NS-L	149
NS A-AT	150
NSG-AC	151
NSG-ACR	151
MS-BT	152
NS-CR	152
PST-SB	153
PST-SP	153
BS	153
NS-P	154
NSP-TT	154
NSP-C	155
NSP-SP	155
PPS	156
PPS-T	156
CR	156
NST	158-161
883 TRACCIANTI	162

VINILESTERE E IBRIDO

Ancoranti chimici a base vinilestere e ibridi senza stirene, progettati per fissaggi strutturali ad alte prestazioni su calcestruzzo fessurato e non fessurato. Certificati ETA per applicazioni sismiche (C1, C2), garantiscono elevata resistenza meccanica, assenza di restringimenti e durabilità in ambienti umidi, fori carotati e allagati.

APPLICAZIONI CLS COMPRESSO, CLS FESSURATO, CLS ARMATO, MATTONI PIENI E FORATI, LEGNO, MATERIALI AD ALTA DENSITÀ E COMPATTEZZA

NCE - Ancoranti chimici a iniezione a base di vinilestere senza stirene. Idoneo per l'impiego in zone sismiche C1 - C2



CARATTERISTICHE

Ancorante chimico a iniezione a base vinilestere senza stirene, certificato ETA per applicazioni strutturali su calcestruzzo fessurato (C1, C2). Indicato per il fissaggio di barre filettate e ferri di armatura, offre tempi di indurimento rapidi e un'elevata resistenza meccanica e all'idrolisi alcalina. Adatto a carpenteria pesante, elementi prefabbricati, riprese di getto e strutture di supporto. Temperature di utilizzo: -10°C ÷ 35°C.

CERTIFICAZIONI

ETA OPZ. 1 - PER ZONE COMPRESSE



Codice	Descrizione	Scatola singola	Imballo complessivo
NB63845	Ancorante chimico vinilestere NCE 300 ml senza stirene	12 pz	-
NB6842	Ancorante chimico vinilestere NCE 345 ml senza stirene	12 pz	-
NB54973	Ancorante chimico vinilestere NCE 400 ml senza stirene	12 pz	-

NCE PLUS - Ancoranti chimici a iniezione a base di uretan metacrilato ibrido senza stirene. Idoneo per l'impiego in zone sismiche C1 - C2



CARATTERISTICHE

Ancorante chimico a iniezione a base di uretan metacrilato ibrido senza stirene, certificato ETA per uso strutturale su calcestruzzo fessurato (C1, C2). Progettato per carichi elevati, garantisce massima durabilità, resistenza chimica e assenza di restringimenti. Ottimizzato per barre filettate e ferri di armatura, è compatibile con calcestruzzo fessurato e non fessurato, pietra naturale compatta, muratura piena e legno. Idoneo per fori carotati, ambienti umidi e fori allagati, esclusa acqua marina. Temperature di utilizzo: -10°C ÷ 35°C.

CERTIFICAZIONI

SISMICO C1 M8-M30 C2 M12-M24

CERTIFICATO OPZIONE 1 PER ZONE TESE, FESSURATE E COMPRESSE M8- M30



Codice	Descrizione	Scatola singola	Imballo complessivo
NB63850	Ancorante chimico ibrido NCE PLUS 300 ml senza stirene	12 pz	-
NB54980	Ancorante chimico ibrido NCE PLUS 420 ml senza stirene	12 pz	-

POLIESTERE

Ancoranti chimici a base poliestere, con e senza stirene, per fissaggi medio-pesanti su calcestruzzo non fessurato e murature. Idonei per ambienti umidi e allagati.

APPLICAZIONI CLS, MATTONI PIENI, MATTONI FORATI, LEGNO COMPATTO

NCF - Ancoranti chimici a iniezione a base poliestere senza stirene



CARATTERISTICHE

Ancorante chimico a iniezione a base poliestere senza stirene, indicato per fissaggi medio-pesanti in applicazioni non critiche. Formula a rapido indurimento, idonea per ambienti interni e spazi chiusi. Versatile su murature piene, forate, calcestruzzo aerato e supporti lignei lamellari o compatti, con resistenza variabile in base alla struttura del materiale. Applicabile in verticale, ambienti umidi, fori allagati e riparazioni di crepe strutturali. Temperature di utilizzo: -10°C ÷ 35°C.

CERTIFICAZIONI

ETAG 029 PER USO SU MURATURA

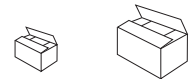

Codice	Descrizione	Scatola singola	Imballo complessivo
NB61827	Ancorante chimico poliestere NCF 300 ml senza stirene	12 pz	-
NB51040	Ancorante chimico poliestere NCF 400 ml senza stirene	12 pz	-

NCS - Ancoranti chimici a iniezione a base di poliestere con stirene



CARATTERISTICHE

Ancorante chimico a iniezione a base poliestere con stirene, idoneo per fissaggi medio-pesanti in applicazioni non critiche. Indicato per barre filettate e ferri di armatura, garantisce buona adesione e resistenza meccanica. Ottimizzato per applicazioni in ambienti esterni. Temperature di utilizzo: -10°C ÷ 35°C.

CERTIFICAZIONI

ETAG 029 PER USO SU MURATURA

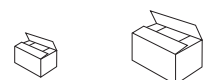

Codice	Descrizione	Scatola singola	Imballo complessivo
NB61820	Ancorante chimico poliestere NCS 300 ml con stirene	12 pz	-
NB51030	Ancorante chimico poliestere NCS 410 ml con stirene	12 pz	-

RESINA EPOSSIDICA

NCX 585 - Ancorante chimico a iniezione a base di resina epossidica pura. Idoneo per l'impiego in zone sismiche C1 - C2



CARATTERISTICHE

Ancorante chimico a iniezione a base di resina epossidica pura (3:1) senza stirene, certificato ETA per uso strutturale su calcestruzzo fessurato (C1, C2). Ideale per fissaggi di barre filettate e ferri di armatura, anche in fori carotati e sommersi.

Elevata resistenza ai carichi pesanti senza restringimenti. Adatto per applicazioni sopra testa, ambienti umidi e alte temperature (comprese fra 0°C - 40°C).

Compatibile con calcestruzzo armato, pietra naturale e mattone pieno.

Da utilizzare con pistola side by side art. PST-NCX e Mixer NCX.

CERTIFICAZIONI

SISMICA C2 M12-M16 PER ZONE COMPRESSE M8-M32

EAD 330499-00-0601 calcestruzzo fessurato M8-M30, calcestruzzo non fessurato M8-M30, barre aderenza migliorata Ø8-Ø32mm applicazioni zona sismica C1: M8-M16, applicazioni zona sismica C2: M12-M16

EAD 330087-00-0601 barre ad aderenza migliorata post-installate Ø8-Ø40mm Resistenza al fuoco in ETA per uso su barre postinstallate



Codice	Descrizione	Scatola singola	Imballo complessivo
NB54585	Ancorante chimico epossidico NCX 585 ml senza stirene	12 pz	-

PST-NCX - Pistola professionale per cartucce NCX side by side



Codice	Descrizione	Scatola singola	Imballo complessivo
NB4030	Pistola professionale PST-NCX per cartucce side by side	1 pz	1 pz

MIXER PER NCX - Miscelatore con elicoidale interno specifico per NCX



Codice	Descrizione	Buste singola	Imballo complessivo
NB6870	Mixer con elicoidale per ancorante chimico NCX	12 pz	10 Buste

Prolunghe

NB6873	Prolunga Mixer NCX da 250 mm	12 pz	10 Buste
NB6876	Prolunga Mixer NCX da 1000 mm	12 pz	10 Buste

ACCESSORI FISSAGGI CHIMICI

Gamma completa di strumenti professionali per l'estrusione e la miscelazione di ancoranti chimici, con soluzioni dedicate per una posa in opera precisa ed efficiente. Progettati per garantire l'applicazione ottimale di sistemi a base resinosi in ogni condizione di installazione.

PST-RB - Pistola Basic per ancoranti chimici



Codice	Descrizione	Scatola singola	Imballo complessivo
NB4055	Pistola Basic per cartucce da 300 ml	1 pz	12 scatole

PST-RP - Pistola Professionale per ancoranti chimici



Codice	Descrizione	Busta singola	Imballo complessivo
NB4057	Pistola Professionale per cartucce da 400 ml	1 pz	12 scatole

PST-BT - Pistola elettrica per ancoranti chimici



Codice	Descrizione	Scatola singola	Imballo complessivo
NB98947	Pistola elettrica per cartucce da 380/420 ml	1 pz	1 scatola
Ricambi			
NB98948	Batteria di ricambio per pistola PST-BT	1 pz	1 scatola

MIXER - Miscelatore con elicoidale interno per ancoranti chimici



Codice	Descrizione	Busta singola	Imballo complessivo
NB6859	Mixer con elicoidale per ancoranti chimici	50 pz	2 Buste
NB98205	Mixer con elicoidale per ancoranti chimici in busta	12 pz	10 Buste

ACCESSORI FISSAGGI CHIMICI

AM - Pompa di soffiaggio per la rimozione della polvere

Essenziale per rimuovere la polvere dal supporto prima dell'applicazione dell'ancorante chimico.



Codice	Descrizione	Scatola singola
NB4060	Pompa di soffiaggio AM per la rimozione della polvere	1 pz

SCO - Scovolini in acciaio per la pulizia del foro

Progettato per eliminare i residui e migliorare l'aderenza dell'ancorante nella fase di installazione.



Codice	Descrizione	Scatola singola	Imballo complessivo
NB72533	Scovolino SCO Ø 10 in acciaio	1 pz	5 scatole
NB72540	Scovolino SCO Ø 12 in acciaio	1 pz	5 scatole
NB72557	Scovolino SCO Ø 14 in acciaio	1 pz	5 scatole
NB72564	Scovolino SCO Ø 18 in acciaio	1 pz	5 scatole
NB72571	Scovolino SCO Ø 24 in acciaio	1 pz	5 scatole

ACCESSORI FISSAGGI CHIMICI

ALB - Alberini godronati in acciaio per il fissaggio chimico su supporti pieni



Bussola in acciaio con filettatura interna e superficie esterna godronata per un'aderenza ottimale.



Codice	Descrizione	Ø Foro muro	Scatola singola	Imballo complessivo
NB5807	Alberino ALB 6x48 in acciaio per fissaggio chimico	8	50 pz	10 scatole
NB5814	Alberino ALB 8x80 in acciaio per fissaggio chimico	12	50 pz	5 scatole
NB5821	Alberino ALB 10x80 in acciaio per fissaggio chimico	14	50 pz	5 scatole
NB5838	Alberino ALB 12x80 in acciaio per fissaggio chimico	16	50 pz	5 scatole



Disponibile in blister

GN - GDN - Gabbiette in polipropilene per il fissaggio chimico su laterizi forati e cappotti

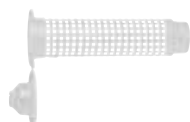

Gabbietta con blocco posteriore per l'alloggiamento della barra filettata e blocco anteriore a imbuto per un centraggio accurato dell'elemento di fissaggio.



Codice	Descrizione	Scatola singola	Imballo complessivo
NB4084	Gabbietta in polipropilene singola GN 12x50 per fissaggio chimico	100 pz	5 scatole
NB98632	Gabbietta in polipropilene singola GN 12x80 per fissaggio chimico	50 pz	5 scatole
NB4091	Gabbietta in polipropilene singola GN 15x85 per fissaggio chimico	50 pz	5 scatole
NB41836	Gabbietta in polipropilene doppia GDN 15x130 per fissaggio chimico	40 pz	2 scatole
NB4095	Gabbietta in polipropilene singola GN 16x85 per fissaggio chimico	50 pz	5 scatole
NB4107	Gabbietta in polipropilene singola GN 20x85 per fissaggio chimico	20 pz	5 scatole
NB4216	Gabbietta in polipropilene prolungata GDN 18x165 per fissaggio su cappotti	10 pz	45 buste
NB4221	Gabbietta in polipropilene prolungata GDN 18x215 per fissaggio su cappotti	10 pz	40 buste
NB4229	Gabbietta in polipropilene prolungata GDN 18x295 per fissaggio su cappotti	10 pz	25 buste



Disponibile in blister

GM - Gabbiette in acciaio per fissaggi chimici a profondità variabile fino a 1 m



Codice	Descrizione	Busta singola pz	Imballo
NB61834	Gabbietta GM ø 12 in acciaio per profondità fino a 1 m	10 pz	10 scatole
NB61841	Gabbietta GM ø 16 in acciaio per profondità fino a 1 m	10 pz	10 scatole
NB61858	Gabbietta GM ø 22 in acciaio per profondità fino a 1 m	5 pz	10 scatole

ACCESSORI FISSAGGI CHIMICI

VCG - Viti di giunzione. Passo metrico e passo legno



Codice	Descrizione	Ø V mm	LT mm	Scatola singola	Imballo complessivo
NB11709	Vite di giunzione 6x80 doppio filetto passo metrico e passo legno	6	80	200 pz	10 scatole
NB11716	Vite di giunzione 8x90 doppio filetto passo metrico e passo legno	8	90	100 pz	5 scatole
NB11723	Vite di giunzione 8x100 doppio filetto passo metrico e passo legno	8	100	100 pz	5 scatole
NB11730	Vite di giunzione 8x110 doppio filetto passo metrico e passo legno	8	110	100 pz	5 scatole
NB11747	Vite di giunzione 8x160 doppio filetto passo metrico e passo legno	8	160	100 pz	5 scatole
NB11754	Vite di giunzione 10x100 doppio filetto passo metrico e passo legno	10	100	50 pz	5 scatole
NB11761	Vite di giunzione 10x120 doppio filetto passo metrico e passo legno	10	120	50 pz	5 scatole
NB11778	Vite di giunzione 10x140 doppio filetto passo metrico e passo legno	10	140	50 pz	5 scatole
NB11785	Vite di giunzione 10x180 doppio filetto passo metrico e passo legno	10	180	50 pz	5 scatole
NB29896	Vite di giunzione 10x230 doppio filetto passo metrico e passo legno	10	230	50 pz	5 scatole

BR - Barrette filettate con dado e rondella. Classe di resistenza 4.8



Codice	Descrizione	Ø T mm	LT mm	Busta singola pz	Imballo
NB41867	Barretta filettata BR 6x60 con dado e rondella	6	60	50	2.000
NB41868	Barretta filettata BR 6x70 con dado e rondella	8	70	50	500
NB4121	Barretta filettata BR 8x100 con dado e rondella	8	100	50	500
NB41870	Barretta filettata BR 8x110 con dado e rondella	8	110	50	500
NB45421	Barretta filettata BR 8x125 con dado e rondella	8	125	50	500
NB45425	Barretta filettata BR 8x150 con dado e rondella	8	150	50	250
NB4138	Barretta filettata BR 10x110 con dado e rondella	10	110	50	250
NB41872	Barretta filettata BR 10x130 con dado e rondella	10	130	50	250
NB4145	Barretta filettata BR 10x145 con dado e rondella	10	145	50	250
NB4152	Barretta filettata BR 12x100 con dado e rondella	12	100	25	250
NB45414	Barretta filettata BR 12x110 con dado e rondella	12	110	25	250
NB41874	Barretta filettata BR 12x160 con dado e rondella	12	160	25	250
NB48279	Barretta filettata BR 16x140 con dado e rondella	16	140	10	250
NB41876	Barretta filettata BR 16x190 con dado e rondella	16	190	10	250

A richiesta in acciaio Inox A2 - AISI 304, Inox A4 - 316.

ACCESSORI FISSAGGI CHIMICI

OC - Occhioli chiusi con filettatura metrica. Classe 66 UNI 5542-65



In ferro stampato a freddo, zincato bianco.



Codice	Descrizione	Ø T mm	LT mm	Scatola singola	Imballo complessivo
NB34371	Occhiolo chiuso OC 5x45 con filettatura metrica	5	45	200 pz	10 scatole
NB34388	Occhiolo chiuso OC 6x55 con filettatura metrica	6	55	100 pz	10 scatole
NB34395	Occhiolo chiuso OC 8x65 con filettatura metrica	8	65	50 pz	10 scatole
NB34401	Occhiolo chiuso OC 10x73 con filettatura metrica	10	73	50 pz	5 scatole
NB34418	Occhiolo chiuso OC 12x90 con filettatura metrica	12	90	25 pz	5 scatole
NB34425	Occhiolo chiuso OC 16x100 con filettatura metrica	16	100	25 pz	2 scatole

Disponibile in blister

GA - Ganci con filettatura metrica. Classe 66 UNI 5542-65



In ferro stampato a freddo, zincato bianco.



Codice	Descrizione	Scatola singola	Imballo complessivo
NB34432	Gancio GA 6x55 con filettatura metrica	100 pz	10 scatole
NB34449	Gancio GA 8x65 con filettatura metrica	50 pz	10 scatole
NB34456	Gancio GA 10x73 con filettatura metrica	50 pz	5 scatole
NB34463	Gancio GA 12x90 con filettatura metrica	25 pz	5 scatole
NB34470	Gancio GA 16x100 con filettatura metrica	25 pz	2 scatole

MULTIUSO

Siliconi monocomponenti a polimerizzazione acetica e neutra, ideali per sigillature generali in edilizia, industria e fai da te. Offrono elevata adesione su superfici lisce e miste, resistenza a muffa, agenti atmosferici e variazioni termiche.



911 NS-A - Silicone acetico



CARATTERISTICHE

Sigillante silconico monocomponente a polimerizzazione acetica, ideale per superfici lisce. Forma un incollaggio permanente e flessibile con un'ottima adesione su vetro, ceramica, piastrelle e superfici vetrate, risultando perfetto per sigillature in bagni e cucine.

Resistente alla muffa, non cola e mantiene la flessibilità in condizioni termiche comprese tra -40°C e +100°C. Rapida reticolazione per un'asciugatura immediata al tatto.

- CON ANTIMUFFA
- NON VERNICIABILE
- ASCIUGATURA RAPIDA



Codice	Descrizione	Colore	Ral	Capacità	Imballo
NB6600	Silicone acetico 911 NS A-TR	Trasparente	-	280 ml	24 pz
NB6601	Silicone acetico 911 NS A-BI	Bianco	9010	280 ml	24 pz
NB6603	Silicone acetico 911 NS A-NE	Nero	9005	280 ml	12 pz
NB6605	Silicone acetico 911 NS A-AV	Avorio	1013	280 ml	12 pz

993 NS-N - Silicone neutro



CARATTERISTICHE

Sigillante silconico neutro monocomponente a polimerizzazione alcolica a basso modulo, ideale per superfici miste e materiali sensibili. Garantisce adesione permanente su PVC, policarbonato, vetro, ceramica, legno e superfici alcaline.

Resistente a muffa, raggi UV e agenti atmosferici, non ingiallisce e mantiene la flessibilità tra -40°C e +120°C. Formulazione a basso odore, non corrosiva sui metalli.

- CON ANTIMUFFA
- NON INGIALLISCE
- NON VERNICIABILE



Codice	Descrizione	Colore	Ral	Capacità	Imballo
NB6630	Silicone neutro 993 NS N-TR	Trasparente	-	310 ml	24 pz
NB6631	Silicone neutro 993 NS N-BI	Bianco	9010	310 ml	24 pz
NB6635	Silicone neutro 993 NS N-AL	Alluminio	9006	310 ml	12 pz
NB6638	Silicone neutro 993 NS N-TM	Moro	8019	310 ml	12 pz

PROFESSIONALI

Siliconi ad alte prestazioni, formulati per rispondere alle esigenze specifiche dei professionisti. Soluzioni dedicate per applicazioni con caratteristiche avanzate di adesione, resistenza chimica e durabilità.

912 NS-AS - Silicone per sanitari



CARATTERISTICHE

Sigillante siliconico monocomponente a polimerizzazione acetica, ideale per applicazioni sanitarie in ambienti ad alta umidità. Polimerizza a temperatura ambiente sotto l'azione dell'umidità atmosferica, garantendo una sigillatura permanente su vetro, ceramica, piastrelle e superfici vetrate.

Resistente alla muffa, non cola e mantiene la flessibilità tra -40°C e +100°C. Reticolazione rapida per un'asciugatura immediata al tatto, ottima lavorabilità senza primer.

- ANTIMUFFA
- RESISTENTE AI RAGGI UV
- NON COLA



Codice	Descrizione	Colore	Ral	Capacità	Imballo
NB6620	Silicone per sanitari 912 NS AS-TR	Trasparente	-	280	24 pz
NB6621	Silicone per sanitari 912 NS AS-BI	Bianco	9010	280	24 pz

934 NS-L - Silicone lattoneria



CARATTERISTICHE

Sigillante siliconico monocomponente a polimerizzazione neutra alcolica, a basso modulo, per sigillature edilizie e applicazioni esterne. Polimerizza a temperatura ambiente sotto l'azione dell'umidità atmosferica, garantendo un'adesione eccellente su substrati alcalini e metallici senza corrosione.

Perfetto per la posa di coperture in lamiera, giunti di dilatazione, perimetrali e connessioni tra strutture. Resistente agli agenti atmosferici, flessibile da -40°C a +150°C, finitura opaca e rapida reticolazione.

- ESENTE DA RITIRI
- OPACO
- FLESSIBILE E INODORE



Codice	Descrizione	Colore	Ral	Capacità	Imballo
NB6650	Silicone per lattoneria 934 NS L-GR	Grigio	7035	310 ml	12 pz
NB6652	Silicone per lattoneria 934 NS L-TM	Moro	8019	310 ml	12 pz

PROFESSIONALI

Siliconi ad alte prestazioni, formulati per rispondere alle esigenze specifiche dei professionisti. Soluzioni dedicate per applicazioni con caratteristiche avanzate di adesione, resistenza chimica e durabilità.

952 NS A-AT - Silicone alte temperature



CARATTERISTICHE

Sigillante siliconico monocomponente a polimerizzazione acetica, progettato per applicazioni edilizie e industriali ad alte temperature. Polimerizza a temperatura ambiente sotto l'azione dell'umidità atmosferica, formando una gomma elastica e resistente fino a +260°C, con stabilità a brevi esposizioni fino a +300°C.

Ideale per sigillature di forni, camini, canne fumarie e componenti sottoposte a stress termico. Elevata adesione su vetro, ceramica, metalli e superfici vetrate. Resistente agli agenti atmosferici e chimici.

- ACETICO ROSSO
- ESPOSIZIONE COSTANTE A 260°C
- RESISTE A PICCHI DI 300°C



Codice	Descrizione	Colore	Ral	Capacità	Imballo
NB6662	Silicone alte temperature 952 NS A-AT	● Rosso	-	310 ml	12 pz

Il silicone alte temperature è ideale per applicazioni su impianti, caldaie, canne fumarie e componenti industriali esposti a stress termico.



SIGILLANTI

Sigillanti con eccellenti prestazioni tecniche per applicazioni edili, industriali e specialistiche. Formulazioni avanzate per la sigillatura, la riparazione e l'impermeabilizzazione, che garantiscono adesione, elasticità e resistenza nel tempo.

930 NSG-AC - Sigillante acrilico



CARATTERISTICHE

Colla di montaggio monocomponente a base acrilica in dispersione acquosa, caratterizzata da una struttura tixotropica che garantisce un'elevata tenacità e un effetto ventosa immediato.

Aderisce su polistirolo, pannelli isolanti, cartongesso, legno, materiali fibrocementizi e superfici porose. Verniciabile dopo l'indurimento. Formulazione priva di solventi e inodori.

- INODORE
- VERNICIABILE
- EFFETTO VENTOSA IMMEDIATO



Codice	Descrizione	Colore	Ral	Capacità	Imballo
NB6625	Sigillante acrilico 930 NSG AC-BI	○ Bianco	9010	310 ml	24 pz
NB6626	Sigillante acrilico 930 NSG AC-GR	● Grigio	7030	310 ml	24 pz

931 NSG-ACR - Sigillante acrilico effetto ruvido



CARATTERISTICHE

Sigillante monocomponente a base di resine acriliche in dispersione acquosa, con struttura tixotropica che facilita l'applicazione anche in verticale.

Formulato con inerti a granulometria controllata, riproduce l'effetto dell'intonaco ruvido, mimetizzando la sigillatura su superfici porose come calcestruzzo, intonaco e laterizio. Ottima adesione senza primer, sovraverniciabile, resistente ai raggi UV e con movimento dilatatorio ammesso fino all'11%.

- ADESIONE SU SUPPORTI POROSI
- VERNICIABILE
- EFFETTO INTONACO RUVIDO



Codice	Descrizione	Colore	Ral	Capacità	Imballo
NB6628	Sigillante acrilico 931 NSG ACR effetto ruvido	○ Bianco	9010	310 ml	24 pz

SIGILLANTI

Sigillanti con eccellenti prestazioni tecniche per applicazioni edili, industriali e specialistiche. Formulazioni avanzate per la sigillatura, la riparazione e l'impermeabilizzazione, che garantiscono adesione, elasticità e resistenza nel tempo.

981 MS-BT - Sigillante bituminoso



CARATTERISTICHE

Sigillante bituminoso monocomponente ad alta adesione, formulato per incollaggi a freddo e sigillature su membrane bituminose prefabbricate. Polimerizza rapidamente, garantendo un'adesione tenace anche su superfici umide o bagnate.

Specificamente progettato per la riparazione localizzata di guaine deteriorate, la sigillatura di sormonti tra membrane, comignoli, lucernari e giunti con calcestruzzo in verticale. Elevata elasticità (allungamento a rottura 65%), resistenza agli agenti atmosferici e stabilità ai raggi UV.

- IMPERMEABILIZZAZIONE IMMEDIATA
- NON COLA
- ADERISCE ANCHE SU UMIDO O BAGNATO



Codice	Descrizione	Colore	Ral	Capacità	Imballo
NB6681	Sigillante bituminoso 981 MS-BT	● Nero	-	310 ml	12 pz

971 NS-CR - Sigillante cristallino



CARATTERISTICHE

Sigillante adesivo monocomponente a base di polimero ibrido con terminazione silanica, caratterizzato da un'elevata trasparenza cristallina.

Indurisce per reazione con l'umidità dell'aria, formando un legame elastico e resistente nel tempo. Ideale per incollaggi e sigillature su vetro, specchi, acquari e materiali lisci, con eccellente adesione senza primer. Esente da solventi e isocianati, inodore, sovraverniciabile e resistente ai raggi UV e all'invecchiamento.

- TRASPARENZA CRISTALLINA
- ADESIONE VETRO SU VETRO
- ANCHE PER ACQUARI



Codice	Descrizione	Colore	Ral	Capacità	Imballo
NB6671	Sigillante cristallino 971 NS CR	○ Cristallino	-	310 ml	12 pz

ACCESSORI SILICONI E SIGILLANTI

Gamma di pistole manuali e accessori per l'estrusione precisa di siliconi e sigillanti. Compatibili con tutte le cartucce coassiali, garantiscono controllo nell'applicazione e massima efficienza.

PST-SB - Pistola Basic per silicone



Codice	Descrizione	Scatola singola	Imballo complessivo
NB6866	Pistola Basic per silicone da 280/310 ml	1 pz	12 scatole

PST-SP - Pistola Professionale per silicone



Codice	Descrizione	Scatola singola	Imballo complessivo
NB5876	Pistola Professionale per silicone da 280/310 ml	1 pz	12 scatole

BS - Beccuccio di ricambio per cartucce silicone



Codice	Descrizione	Busta singola	Imballo complessivo
NB6850	Beccuccio di ricambio per cartucce silicone NS	12 pz	10 Buste

Le pistole per siliconi Nobex sono un'attrezzatura indispensabile per garantire una perfetta esecuzione nell'applicazione dei sigillanti.



POLIURETANICHE

Schiume poliuretaniche monocomponenti per sigillature, isolamento e fissaggi in edilizia. Formulazioni a bassa e alta espansione, adatte ad applicazioni universali e specialistiche.

308 NSP - Schiume poliuretaniche universali



CARATTERISTICHE

Schiama poliuretanicca monocomponente a espansione controllata, indurente con l'umidità atmosferica. Adesione eccellente su materiali da costruzione come cemento, mattoni, legno, metalli e PVC rigido.

Ideale per la sigillatura di serramenti, crepe, interstizi e giunzioni di pavimentazioni. Disponibile in versione manuale e per applicazione con pistola.

- COEFFICIENTE DI CONDUCIBILITÀ TERMICA $\lambda = 0,040$ W/mK (uso manuale) 0,036 W/mK (per pistola)
- CLASSE DI RESISTENZA AL FUOCO B3 (DIN 4102) | F (EN 13501-1:2008)
- PER SIGILLATURE E RIEMPIMENTI



Codice	Descrizione	Utilizzo	Capacità	Imballo
NB6700	Schiama poliuretanicca 308 NSP uso manuale	Manuale	750 ml	12 pz
NB6705	Schiama poliuretanicca 308 NSP per pistola	Pistola	750 ml	12 pz

355 NSP-TT - Schiume poliuretaniche per tetti



CARATTERISTICHE

Schiama poliuretanicca monocomponente ad alta adesione e bassa espansione, progettata per applicazioni su coperture e sigillature in edilizia. Indurisce con l'umidità atmosferica e garantisce un'adesione eccellente su cemento, mattoni, legno, metalli e PVC rigido.

Disponibile in due versioni: manuale, per un'applicazione versatile, e per pistola, per maggior precisione e controllo.

- COEFFICIENTE DI CONDUCIBILITÀ TERMICA $\lambda = 0,036$ W/mK (uso manuale e per pistola)
- ISOLAMENTO ACUSTICO ≥ 62 dB
- CLASSE DI RESISTENZA AL FUOCO B3 (DIN 4102) | F (EN 13501-1:2008)



Codice	Descrizione	Utilizzo	Capacità	Imballo
NB6740	Schiama poliuretanicca per tetti 355 NSP M-TT uso manuale	Manuale	750 ml	12 pz
NB6745	Schiama poliuretanicca per tetti 355 NSP P-TT 750 per pistola	Pistola	750 ml	12 pz

POLIURETANICHE

377 NSP-C - Schiuma poliuretana per cappotti



CARATTERISTICHE

Schiuma adesiva poliuretana monocomponente, certificata B2 per sistemi a cappotto ETICS. Progettata per l'incollaggio di pannelli isolanti EPS e XPS su pareti, tetti piani e fondazioni.

A bassa espansione, elimina i ponti termici e livella fino a 30 mm. Assicura un'applicazione precisa e una copertura fino a 10 m² ed è tassellabile dopo solo 2 ore dall'applicazione.

- COEFFICIENTE DI CONDUCEBILITÀ TERMICA $\lambda = 0,035$ W/mK (per pistola)
- CLASSE DI RESISTENZA AL FUOCO B2 (DIN 4102) | E (EN 13501-1:2008)
- CORREGGE FINO A 30MM DI IRREGOLARITÀ



Codice	Descrizione	Utilizzo	Capacità	Imballo
NB6760	Schiuma poliuretana per cappotti 377 NSPC	Pistola	750 ml	12 pz

304 NSP-SP - Solvente pulitore per schiuma poliuretana



CARATTERISTICHE

Solvente specifico per la rimozione di schiume poliuretatiche non indurite e residui di adesivi. Indicato per la pulizia delle valvole delle bombole e per la manutenzione interna ed esterna delle pistole applicatrici.

Ideale anche per sgrassare superfici metalliche da oli, grassi, fuliggine, catrame e mastici freschi, garantendo un supporto pulito prima dell'applicazione di sigillanti e adesivi.

- PULISCE PISTOLE E VALVOLE
- RIMUOVE SCHIUME E ADESIVI
- SGRASSA E PREPARA LE SUPERFICI



Codice	Descrizione	Utilizzo	Capacità	Imballo
NB6799	Solvente pulitore 304 NSP SP	Pistola	500 ml	12 pz

ACCESSORI PER SCHIUME

Pistole professionali e componenti di ricambio progettati per garantire controllo del flusso, riduzione degli sprechi e massima efficienza nell'estrusione delle schiume poliuretatiche.

PPS - Pistola professionale per schiuma

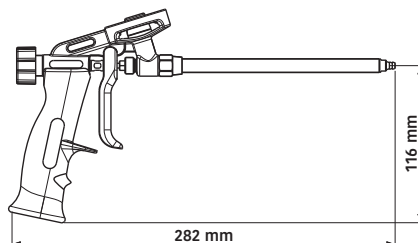

Codice	Descrizione	Scatola singola	Imballo complessivo
NB6810	Pistola professionale per schiuma PPS	1 pz	1 scatola

PPS-T - Pistola professionale per schiuma con valvola teflonata

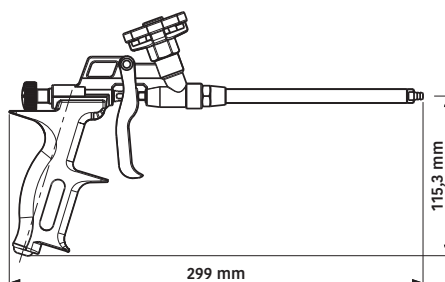

Codice	Descrizione	Scatola singola	Imballo complessivo
NB6830	Pistola professionale con valvola teflonata PPS-T	1 pz	1 scatola

CR - Cannuccia di ricambio per bombole schiume uso manuale



Codice	Descrizione	Busta singola	Imballo complessivo
NB6840	Cannuccia di ricambio per bombole schiume uso manuale	12 pz	10 buste



▲ Quando si lavora in ambienti umidi, come bagni e cucine, il Silicone sanitari 912 è la scelta ideale per applicazioni resistenti alla muffa e flessibili nel tempo.



▲ La pistola professionale PPS garantisce un'erogazione precisa e uniforme delle schiume poliuretatiche.

▼ Il Silicone per lattoneria 934 assicura massima tenuta e durata nelle sigillature di lamiere e componenti metallici esposti agli agenti atmosferici.



SPRAY TECNICI

Spray tecnici ad alte prestazioni, sviluppati per garantire massima efficacia in operazioni di manutenzione, protezione e trattamento professionale delle superfici.

NST - Sbloccante lubrificante spray



CARATTERISTICHE

Sbloccante lubrificante tecnico spray con azione rapida contro ossidazioni e grippaggi. Ideale per bulloni, dadi e giunzioni metalliche bloccati dalla ruggine. Forma un film lubrificante protettivo che previene nuove ossidazioni.

Formulazione priva di propellenti CFC, toluolo e idrocarburi alogenati.



Codice	Descrizione	Capacità	Imballo
NB76051	Sbloccante lubrificante NST 50	400 ml	12 pz

NST90SS - Sbloccante Super High Performance spray



CARATTERISTICHE

Sbloccante spray ad alte prestazioni con formula petrolifera ad alta penetrazione. Dissolve rapidamente ruggine e ossidazioni, sblocca efficacemente bulloni, viti e componenti meccanici. Idrorepellente, protegge quadri elettrici e apparati elettromeccanici da umidità e condensa. Formulazione senza solventi clorurati e aromatici, dotato di valvola multidirezionale a 360°.



Codice	Descrizione	Capacità	Imballo
NB76090	Sbloccante NST 90ss Super High Performance	400 ml	12 pz

NST98 - Silicone spray



CARATTERISTICHE

Antiadesivo silconico spray a base di oli dimetilpolisilossanici, con proprietà distaccanti e lubrificanti. Specifico per operazioni di stampaggio gomma-plastica, termoformatura e trattamento superficiale in ambito tessile, calzaturiero e verniciatura. Non lascia residui carboniosi, inodore, esente da solventi aromatici e clorurati. Operativo su ampio intervallo termico, da -35°C fino a +270°C.



Codice	Descrizione	Capacità	Imballo
NB76097	Silicone spray NST 98	400 ml	12 pz

SPRAY TECNICI

NST 125 - Grasso multiuso con PTFE spray



CARATTERISTICHE

Grasso lubrificante multiuso formulato con PTFE e ingredienti di alta qualità, indicato per impieghi industriali. Caratterizzato da elevata capacità antiattrito, consistenza pomatosa NLGI 1/2/3 e base infusibile. Garantisce una lubrificazione duratura e pulita, proteggendo dall'usura componenti meccanici soggetti a movimento e sollecitazioni.



Codice	Descrizione	Capacità	Imballo
NB76125	Grasso multiuso spray NST 125 con PTFE	400 ml	12 pz

NST 100 - Olio di vaselina spray



CARATTERISTICHE

Lubrificante tecnico spray a base di olio bianco minerale ad alto indice di viscosità, formulato per la lubrificazione pulita e inodore di componenti meccanici. Specifica additivazione antimacchia, facilmente lavabile, idoneo per applicazioni su superfici delicate. Indicato per telai tessili, macchinari di precisione e applicazioni dov'è richiesta assenza di residui visibili.



Codice	Descrizione	Capacità	Imballo
NB76100	Olio di vasellina spray NST 100	400 ml	12 pz

NST 80 - Olio da taglio spray

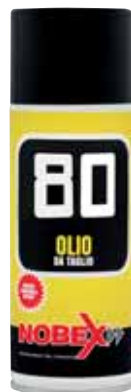

CARATTERISTICHE

Olio intero per lavorazioni meccaniche di maschiatura, filettatura e filettatura a pettine di materiali ferrosi e non ferrosi. Formulato con additivi solforati inattivi per una lubrificazione ad elevata performance che riduce attrito e usura, migliorando finiture e durata degli utensili. Privo di composti alogenati, nocivi e solventi clorurati.



Codice	Descrizione	Capacità	Imballo
NB76080	Olio da taglio spray NST 80	400 ml	12 pz

SPRAY TECNICI

Spray tecnici ad alte prestazioni, sviluppati per garantire massima efficacia in operazioni di manutenzione, protezione e trattamento professionale delle superfici.

NST 150 - Zincante chiaro 99% spray



CARATTERISTICHE

Antiruggine zincante spray monocomponente a base di zinco micropolverizzato in legante inorganico. Forma un legame elettrochimico con il supporto metallico assicurando una protezione anticorrosiva superiore (>350h DIN 50021). Rapida asciugatura, finitura chiara indistinguibile dalla zincatura a caldo. Privo di piombo, nickel e sostanze nocive.



Codice	Descrizione	Capacità ml	Imballo
NB76150	Zincante chiaro 99% spray NST 150	400	12 pz

NST 150 S - Zincante brillante 99% spray



CARATTERISTICHE

Antiruggine zincante monocomponente ad alto peso molecolare con finitura brillante tipo cromo, specifico per applicazioni industriali e outdoor. Garantisce protezione catodica su superfici metalliche, rapida asciugatura (3-5 min fuori polvere), eccellente resistenza agli agenti atmosferici e ai raggi UV. Ideale per coperture, ripristini e ritocchi dopo saldatura. Privo di piombo, nickel e asbesto.



Codice	Descrizione	Capacità	Imballo
NB76152	Zincante brillante 99% spray NST 150 S	400 ml	12 pz

NST 150 GT - Zincante 400°C chiaro 99% spray



CARATTERISTICHE

Antiruggine zincante spray formulato con zinco "Flake" ad alto contenuto, specifico per superfici metalliche e lamierati ferrosi esposti a temperature elevate fino a 400°C. Assicura una protezione catodica eccezionale contro corrosione, salinità, soluzioni acide/alcaline e usura. Indicato per caldareria, impiantistica, carpenteria pesante e componenti sottoposti a stress termico.



Codice	Descrizione	Capacità	Imballo
NB76156	Zincante 400° chiaro 99% spray NST 150 GT	400 ml	12 pz

NST 180 - Pulitore per contatti spray

CARATTERISTICHE

Pulitore spray disossidante e sgrassante per contatti elettrici ed elettronici, a rapida evaporazione. Rimuove efficacemente ossidi, grassi, tracce carboniose e fluxanti di saldatura, senza aggredire plastiche, elastomeri e parti verniciate. Formulazione priva di solventi aromatici, clorurati e idrocarburi alogenati.



Codice	Descrizione	Capacità	Imballo
NB76181	Pulitore per contatti spray NST 180	400 ml	12 pz

NST 250 - Rimuovi silicone spray

CARATTERISTICHE

Prodotto specialistico spray per la rapida rimozione di siliconi parzialmente polimerizzati, mastici e adesivi industriali. Formulato con solventi ossigenati e n-paraffine di petrolio, agisce senza aggredire le superfici, lasciandole pulite, gradevolmente profumate e facilmente lavabili con acqua. Non contiene solventi irritanti o idrocarburi alogenati.



Codice	Descrizione	Capacità	Imballo
NB76250	Rimuovi silicone spray NST 250	400 ml	12 pz

NST 200 - Aria compressa spray

CARATTERISTICHE

Spray tecnico che genera un potente getto di gas a pressione (6 bar a 20°C), ideale per la pulizia rapida e sicura di dispositivi elettronici, ottici e fotografici. Rimuove efficacemente polvere e residui da tastiere, ventole, contatti elettrici e superfici delicate senza macchiare o danneggiare i supporti trattati. Non contiene solventi aromatici, clorurati o idrocarburi alogenati.



Codice	Descrizione	Capacità	Imballo
NB76200	Aria compressa spray NST 200	400 ml	12 pz

SPRAY TRACCIANTI

Traccianti spray ad alta visibilità, ideali per marcature temporanee in ambienti professionali. Formulazioni fluorescenti per una segnalazione efficace e immediata, applicazione semplice e copertura ottimale.

883 - Traccianti fluorescenti



CARATTERISTICHE

Vernici spray traccianti fluorescenti ad alta visibilità, ideali per marcature su cantieri, scavi, linee di demarcazione e segnalazioni temporanee. Formulate con resine elastomeriche modificate, assicurano eccellente ancoraggio su superfici asciutte, resistenza ai raggi UV e alta copertura (8-10 mq/l). Asciugatura rapida (2-3 min fuori polvere) per interventi immediati.



Codice	Descrizione	Colore	Capacità	Imballo
NB75520	Tracciante fluorescente 883 GI	● Giallo	500 ml	12 pz
NB75522	Tracciante fluorescente 883 RO	● Rosso	500 ml	12 pz



▲ Grasso multi funzione per la lubrificazione di organi meccanici



▲ Silicone spray lubrificante e scivolante per metalli e gomme

Pulitore per contatti, rimuove sporco e umidità da interruttori, connettori, motori elettrici, circuiti e pannelli elettrici



**FISSAGGI PONTEGGI
FUNI E CAVI**

FISSAGGI PER PONTEGGI FUNI E CAVI

PTA T1 / PTA T2	166
PTA T3 / PTA T4	167
PTA K / OC-G	168
PTRO-G / ABP	169
OC-24 / PTRO	170
NX-OCS / KIT TESTER/TA-U	171
PPPG 48	172
PPPG 18 / T	173
NSB / SQ-T / SQ-I	174
ST / STR 5 / CB	175
CDM / SCM / NGC 50	176
NCT / TPE 48 / FPR	177
CA-R / NS 200 / NS-LB / SPINA VERMALE	178
BULLONE RICAMBIO / SXP-ORD / OR-L	179
CHP / CCHC / CHC	180-181

GOLFARI IN ACCIAIO

Golfare in acciaio forgiato per ponteggi e strutture provvisorie ad espansione per installazione distanziate idoneo per applicazioni su materiali compatti per carichi di elevata portata.

MATERIALI DI SUPPORTO CALCESTRUZZO, PIETRA NATURALE

PTA T1 - Golfare Ø 51 in acciaio

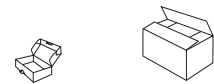
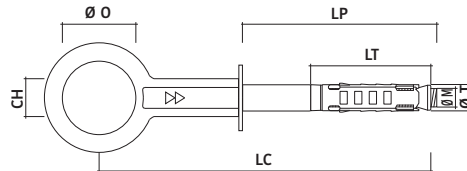
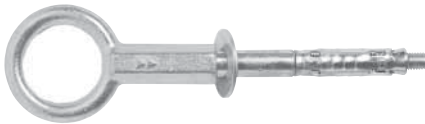
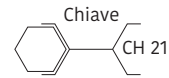

Codice	Descrizione	Ø O mm	LP mm	Ø M mm	Ø T mm	LT mm	LC mm	CH mm	Scatola singola	Imballo complessivo
NB50906	Golfare PTA T1 con barretta estraibile M12-130 E 18	51	130	12	18	75	100	21	10 pz	2 scatole

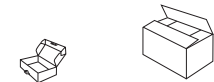
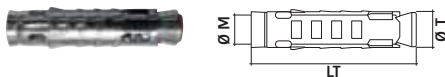

Ricambi per PTA T1

Codice	Descrizione	Ø M mm	LT mm	Ø T mm	Scatola singola	Imballo complessivo
NB1441	Tassello in acciaio SXP 12x75 mm	12	75	18	50 pz	5 scatole
NB86516	Barra filettata B-FIL M 12x100 mm	-	-	-	50 pz	1 scatola
NB86547	Rondella Ø 18 E 45	-	-	-	50 pz	1 scatola

PTA T2 - Golfare Ø 51 in acciaio prolungato

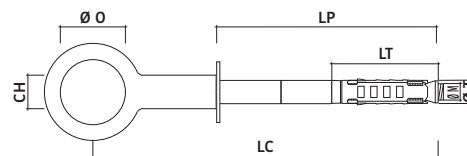
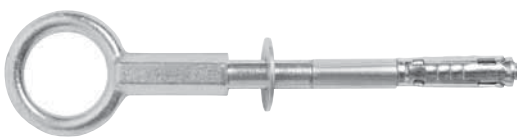

Codice	Descrizione	Ø O mm	LP mm	Ø M mm	Ø T mm	LT mm	LC mm	CH mm	Scatola singola	Imballo complessivo
NB52016	Golfare PTA T2 con barretta estraibile M12-180 E 18	51	180	12	18	75	100	21	10 pz	2 scatole

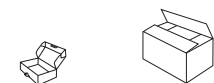
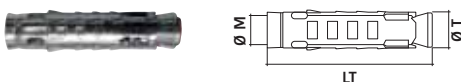

Ricambi per PTA T2

Codice	Descrizione	Ø M mm	LT mm	Ø T mm	Scatola singola	Imballo complessivo
NB1441	Tassello in acciaio SXP 12x75 E 18	12	75	18	50 pz	5 scatole
NB86523	Barra filettata B-FIL M 12x145 mm	-	-	-	50 pz	1 scatola
NB86530	Distanziale golfare D-GOLF 18x50 mm	-	-	-	50 pz	1 scatola
NB86547	Rondella Ø 18 E 45	-	-	-	50 pz	1 scatola

GOLFARI IN ACCIAIO

PTA T3 - Golfare Ø 51 in acciaio a corpo unico

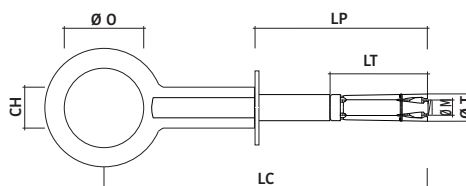
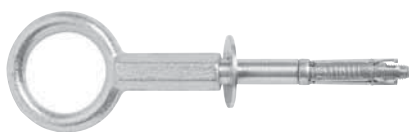

Codice	Descrizione	Ø O mm	LP mm	Ø M mm	Ø T mm	LT mm	LC mm	CH mm	Scatola singola	Imballo complessivo
NB3292	Golfare PTA T3 corpo unico M 10-130 E 16	51	130	10	16	60	205	21	10 pz	2 scatole

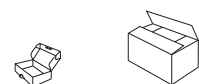
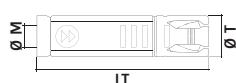

Ricambi per PTA T3

Codice	Descrizione	Ø M mm	LT mm	Ø T mm	Scatola singola	Imballo complessivo
NB60219	Tassello in acciaio non passante HSP 10x60 mm E16	10	60	16	50 pz	5 scatole

PTA T4 - Golfare Ø 51 in acciaio prolungato M10x180

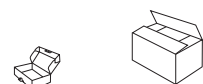
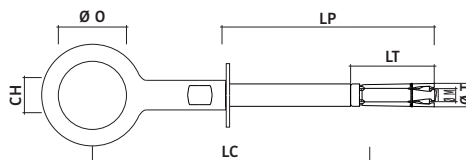
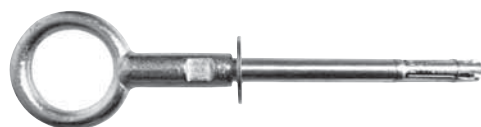

Codice	Descrizione	Ø O mm	LP mm	Ø M mm	Ø T mm	LT mm	LC mm	CH mm	Scatola singola	Imballo complessivo
NB3308	Golfare PTA T4 corpo unico M 10-180 E 16	51	180	10	16	60	280	21	10 pz	2 scatole

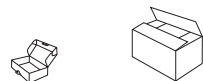
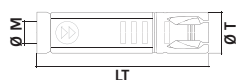

Ricambi per PTA T4

Codice	Descrizione	Ø M mm	LT mm	Ø T mm	Scatola singola	Imballo complessivo
NB60219	Tassello in acciaio HSP 10x60 mm E16	10	60	16	50 pz	5 scatole

Ricambi speciali per golfari da ponteggio



Codice	Descrizione	Ø M mm	L mm	Ø I mm	Scatola singola
NB86509	Barretta filettata B-FIL M 10x85 mm	10	85	-	50 pz
NB87896	Barretta filettata B-FIL M 10x145 mm	10	145	-	50 pz
NB87887	Golfare D-GOLF 16x30 Int.13	16	30	13	50 pz
NB87889	Golfare D-GOLF 16x50 Int.13	16	50	13	50 pz

GOLFARI IN ACCIAIO

Golfare in acciaio forgiato per ponteggi e strutture provvisorie, ad espansione per installazione distanziate. Ideali per applicazioni su materiali compatti in presenza di sistemi a cappotto per carichi di elevata portata.

MATERIALI DI SUPPORTO CALCESTRUZZO, PIETRA NATURALE

PTA-K - Golfare Ø 51 in acciaio per ponteggio specifico per cappotto

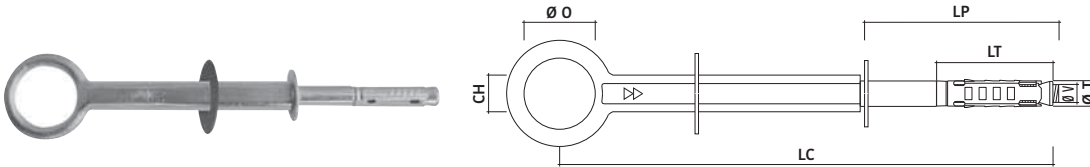

Codice	Descrizione	Ø O mm	LP mm	Ø V mm	Ø T mm	LT mm	LC mm	CH mm	Scatola singola
NB50400	Golfare PTA-K per cappotto M12-335 E18	51	130	12	18	75	235	21	10 pz



Ricambi per PTA-K

Codice	Descrizione	Ø M mm	L mm	Ø T mm	Scatola singola	Imballo complessivo
NB1441	Tassello in acciaio SXP 12x75 E 18	12	75	18	50 pz	5 scatole
NB86547	Rondella Ø 18 E 45	18	-	45	50 pz	-
NB86530	Golfare D-GOLF Ø 18	18	65	-	50 pz	-
NB50412	Rondella in PVC Ø 55	18	-	55	50 pz	-

OC-G - Occhiolo Ø 51 mordente legno filo Ø 12



Codice	Descrizione	Ø O mm	Ø V mm	LV mm	Scatola singola	Imballo complessivo
NB16445	Occhiolo OC-G Ø 12x120 mordente legno	-	12	120	25 pz	4 scatole
NB16483	Occhiolo OC-G Ø 12x140 mordente legno	51	12	140	25 pz	4 scatole
NB16452	Occhiolo OC-G Ø 12x160 mordente legno	51	12	160	25 pz	4 scatole
NB16469	Occhiolo OC-G Ø 12x200 mordente legno	51	12	200	25 pz	4 scatole
NB16476	Occhiolo OC-G Ø 12x240 mordente legno	51	12	240	25 pz	4 scatole
NB16478	Occhiolo OC-G Ø 12x300 mordente legno	51	12	300	25 pz	2 scatole
NB16480	Occhiolo OC-G Ø 12x350 mordente legno	51	12	350	25 pz	2 scatole
NB16482	Occhiolo OC-G Ø 12x400 mordente legno	51	12	400	25 pz	2 scatole
NB16484	Occhiolo OC-G Ø 12x450 mordente legno	51	12	450	25 pz	2 scatole
NB16486	Occhiolo OC-G Ø 12x500 mordente legno	51	12	500	25 pz	2 scatole

GOLFARI IN ACCIAIO

PTRO-G - Golfare Ø 51 in acciaio completo di tassello per materiale pieno e forato

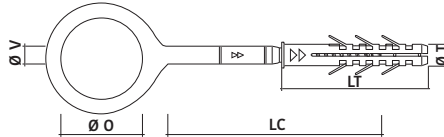

Codice	Descrizione	Ø O mm	LC mm	Ø V mm	Ø T mm	LT mm	Scatola singola	Imballo complessivo
NB3322	Golfare in acciaio e tassello nylon PTRO-G Ø 12x120	51	120	12	14	100	20 pz	2 scatole
NB3339	Golfare in acciaio e tassello nylon PTRO-G Ø 12x140	51	140	12	14	100	20 pz	2 scatole
NB3346	Golfare in acciaio e tassello nylon PTRO-G Ø 12x160	51	160	12	14	100	20 pz	2 scatole
NB3353	Golfare in acciaio e tassello nylon PTRO-G Ø 12x200	51	200	12	14	100	20 pz	2 scatole
NB5715	Golfare in acciaio e tassello nylon PTRO-G Ø 12x240	51	240	12	14	160	20 pz	2 scatole

ABP - Tassello prolungato in nylon Ø 14 - Ø 16

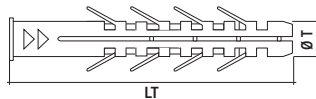

Codice	Descrizione	Ø T mm	LT mm	Scatola singola	Imballo complessivo
NB53792	Tassello prolungato in nylon ABP 14x100	14	100	100 pz	2 scatole
NB8891	Tassello prolungato in nylon ABP 14x130	14	130	100 pz	2 scatole
NB53372	Tassello prolungato in nylon ABP 14x160	14	160	50 pz	2 scatole
NB8907	Tassello prolungato in nylon ABP 16x140	16	140	50 pz	2 scatole
NB8914	Tassello prolungato in nylon ABP 16x160	16	160	50 pz	2 scatole
NB8921	Tassello prolungato in nylon ABP 16x200	16	200	50 pz	2 scatole
NB8938	Tassello prolungato in nylon ABP 16x240	16	240	50 pz	2 scatole

Confezioni industriali



Codice	Descrizione	Ø T mm	LT mm	Scatola singola	Imballo
NB62053	Bulk tassello prolungato in nylon ABP 14x100	14	100	1.600 pz	16 scatole
NB62060	Bulk tassello prolungato in nylon ABP 14x130	14	130	1.200 pz	16 scatole
NB62077	Bulk tassello prolungato in nylon ABP 14x160	14	160	900 pz	16 scatole
NB62084	Bulk tassello prolungato in nylon ABP 16x140	16	140	800 pz	16 scatole
NB62091	Bulk tassello prolungato in nylon ABP 16x160	16	160	500 pz	16 scatole
NB62107	Bulk tassello prolungato in nylon ABP 16x200	16	200	500 pz	16 scatole
NB62114	Bulk tassello prolungato in nylon ABP 16x240	16	240	400 pz	16 scatole

GOLFARI IN ACCIAIO

Golfare Ø 24 per ponteggi e strutture provvisorie composto da occhio mordente legno filo 12 e tassello ad espansione in nylon per installazioni distanziate idoneo per applicazioni su materiali compatti per carichi di elevata portata.

MATERIALI DI SUPPORTO CALCESTRUZZO, PIETRA NATURALE

OC-24 - Occhio Ø 24 mordente legno filo Ø 12

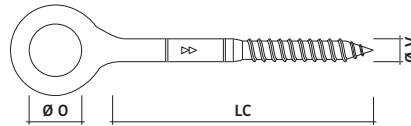

Su materiale pieno e forato

Codice	Descrizione	Ø O mm	LC mm	Ø V mm	Scatola singola	Imballo complessivo
NB16650	Occhio OC-24 Ø 12x90 mordente legno	24	90	12	25 pz	4 scatole
NB16667	Occhio OC-24 Ø 12x120 mordente legno	24	120	12	25 pz	4 scatole
NB16674	Occhio OC-24 Ø 12x160 mordente legno	24	160	12	25 pz	4 scatole
NB16681	Occhio OC-24 Ø 12x190 mordente legno	24	190	12	25 pz	4 scatole
NB16698	Occhio OC-24 Ø 12x230 mordente legno	24	230	12	25 pz	4 scatole
NB88780	Occhio OC-24 Ø 12x260 mordente legno	24	260	12	25 pz	4 scatole
NB88800	Occhio OC-24 Ø 12x300 mordente legno	24	300	12	25 pz	4 scatole
NB88810	Occhio OC-24 Ø 12x350 mordente legno	24	350	12	10 pz	5 scatole
NB88820	Occhio OC-24 Ø 12x400 mordente legno	24	400	12	10 pz	5 scatole
NB88830	Occhio OC-24 Ø 12x450 mordente legno	24	450	12	10 pz	5 scatole
NB88840	Occhio OC-24 Ø 12x500 mordente legno	24	500	12	10 pz	5 scatole

PTRO - Golfare Ø 24 in acciaio completo di tassello nylon

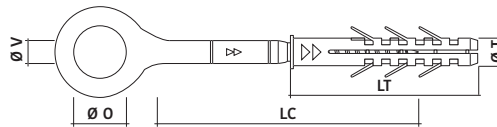

Su materiale pieno e forato

Codice	Descrizione	Ø O mm	LC mm	Ø V mm	Ø T mm	LT mm	Scatola singola	Imballo complessivo
NB3438	Golfari in acciaio e tassello nylon PTRO Ø 12x120	24	120	12	14	100	25 pz	2 scatole
NB3445	Golfari in acciaio e tassello nylon PTRO Ø 12x160	24	160	12	14	100	25 pz	2 scatole
NB3469	Golfari in acciaio e tassello nylon PTRO Ø 12x190	24	190	12	14	100	20 pz	2 scatole
NB3476	Golfari in acciaio e tassello nylon PTRO Ø 12x230	24	230	12	16	160	20 pz	2 scatole
NB3483	Golfari in acciaio e tassello nylon PTRO Ø 12x300	24	300	12	16	200	20 pz	2 scatole

GOLFARI IN ACCIAIO

NX-OCS - Tassello NX con occhio Ø 23

DIPARTIMENTO
INGEGNERIA
CIVILE
ARCHITETTURA
dICAR

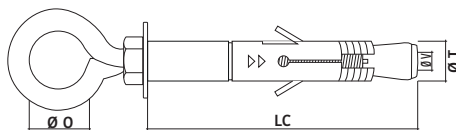

Codice	Descrizione	Ø O mm	Ø V mm	LV mm	Ø T mm	LC mm	Scatola singola	Imballo complessivo
NB102168	Tassello con occhio Ø 23 16x65 mm	23	10	180	16	65	25 pz	5 scatole
NB102169	Tassello con occhio Ø 23 16x95 mm	23	10	213	16	95	25 pz	5 scatole
NB102170	Tassello con occhio Ø 23 16x115 mm	23	10	150	16	115	20 pz	5 scatole

ACCESSORI

KIT TESTER - 20 kN, per prove di estrazione



Kit tester portatile per prove di carico ancoranti 20 kN. Specifico per ponteggi.



Codice	Descrizione	Scatola singola	Imballo complessivo
NB50600	Kit tester portatile KIT-ITA per prove di carico ancoranti 20 kN	1 pz	1

TA-U - Tappo copriforo per ponteggi multi Ø 14 - 16 -18

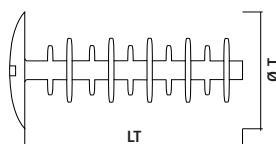

Codice	Descrizione	Ø T mm	LT mm	Scatola singola	Imballo complessivo
NB5790	Tappo copriforo per ponteggi TA-U 18x37 mm	18	37	100 pz	5 scatole

ACCESSORI

PPPG - Prolunghe in acciaio per ancoraggio ponteggi Ø 48 L 300



Codice	Descrizione	Ø tubo mm	L mm	Scatola singola	Imballo complessivo
NB66500	Prolunghe in acciaio per ancoraggio ponteggi PPPG Ø 48 L 300	48	300	1 pz	10 scatole

PPPG - Prolunghe in acciaio per ancoraggio ponteggi Ø 48 L 480



Codice	Descrizione	Ø tubo mm	L mm	Scatola singola	Imballo complessivo
NB68000	Prolunghe in acciaio per ancoraggio ponteggi PPPG Ø 48 L 480	48	480	1 pz	10 scatole

PPPG - Prolunghe in acciaio per ancoraggio ponteggi Ø 48 L 1000



Codice	Descrizione	Ø tubo mm	L mm	Scatola singola	Imballo complessivo
NB68600	Prolunghe in acciaio per ancoraggio ponteggi PPPG Ø 48 L 1000	48	1000	1 pz	10 scatole

ACCESSORI
PPPG - Prolunghe in acciaio per ancoraggio ponteggi Ø 18 L 300

Codice	Descrizione	Ø gancio mm	Ø tubo mm	L mm	Scatola singola	Imballo complessivo
NB66800	Prolunghe in acciaio per ancoraggio ponteggi PPPG Ø 18 L 300	18	48	300	1 pz	10 scatole

PPPG - Prolunghe in acciaio per ancoraggio ponteggi Ø 18 L 500

Codice	Descrizione	Ø gancio mm	Ø tubo mm	L mm	Scatola singola	Imballo complessivo
NB66617	Prolunghe in acciaio per ancoraggio ponteggi PPPG Ø 18 L 500	18	48	500	1 pz	10 scatole

T - Morsetto con gancio per ancoraggio ponteggi

Codice	Descrizione	Ø mm	Ø T mm	L mm	Scatola singola
NB50695	Morsetto con gancio a T per ponteggi Ø 20	20	48	500	10 pz

ACCESSORI PER PONTEGGI IN POLIPROPILENE

Gamma completa di accessori per sicurezza e segnalazione in ambito ponteggiatori e cantieri edili. Sottobasette e ripartitori di carico, coprigiunti, copritubi, funghi di segnalazione, anche personalizzabili, e ricambi per giunti e ponteggi.

APPLICAZIONI Edilizia e ponteggi.

NSB - Sottobasetta quadrata



PRODOTTO CERTIFICATO

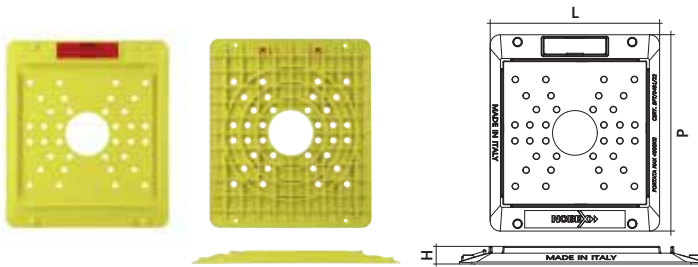

Sottobasetta quadrata per ponteggi con foro centrale di stoccaggio diametro 51 e fori a raggiera sulla superficie per lo scolo dell'acqua. Piatto di alloggiamento con foro di contenimento per la basetta metallica, inchiodabile ai 4 lati, impilabile e con griglia sottostante di ancoraggio. Catarinfrangente con sistema antiganciamento.

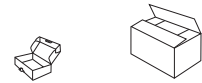

Codice	Descrizione	H mm	L mm	P mm	Scatola singola	Imballo complessivo
NB50050	Sottobasetta quadrata NSB universale 22x19	15,5	185	215	40 pz	-

SQ-T- Sottobasetta rettangolare



PRODOTTO CERTIFICATO

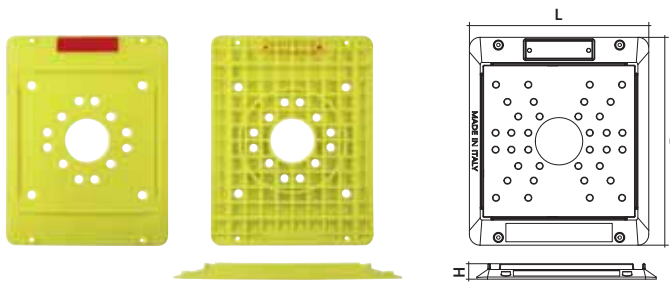

Sottobasetta rettangolare per ponteggi con foro centrale di stoccaggio diametro 51 e fori a raggiera sulla superficie per lo scolo dell'acqua. Piatto di alloggiamento con foro di contenimento per la basetta metallica, inchiodabile ai 4 lati, impilabile e con griglia sottostante di ancoraggio. Catarinfrangente con sistema antiganciamento. Certificata e personalizzabile.

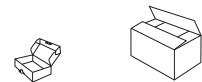

Codice	Descrizione	H mm	L mm	P mm	Scatola singola	Imballo complessivo
NB50090	Sottobasetta rettangolare SQ-T per ponteggi con foro centrale	16	185	215	50 pz	-

SQ-I - Sottobasetta rettangolare inclinata



PRODOTTO CERTIFICATO

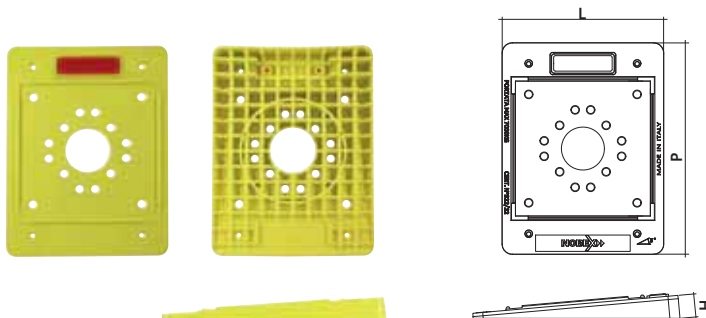

Sottobasetta rettangolare inclinata con angolatura di 5° per ponteggi con foro centrale di stoccaggio diametro 51 e fori a raggiera sulla superficie per lo scolo dell'acqua. Piatto di alloggiamento con foro di contenimento per la basetta metallica, inchiodabile ai 4 lati, impilabile e con griglia sottostante di ancoraggio. Catarinfrangente con sistema anti sganciamento e sovrapponibile fino ad un massimo di 5 sottobasette con un'angolatura di 25° per l'utilizzo su superfici irregolari, inclinate, rampe e tetti a falda. Certificata e personalizzabile.

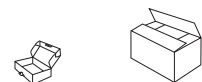

Codice	Descrizione	H max mm	L mm	P mm	Scatola singola	Imballo complessivo
NB50075	Sottobasetta rettangolare SQ-I inclinata con angolatura di 5°	28	188	245	40 pz	-

ACCESSORI PER PONTEGGI IN POLIPROPILENE

ST - Sottobasetta tonda



PRODOTTO CERTIFICATO



Codice	Descrizione	Ø mm	H mm	Scatola singola	Imballo complessivo
NB50110	Sottobasetta tonda ST	210	20	40 pz	-

STR 5 - Ripartitore di carico



PRODOTTO CERTIFICATO

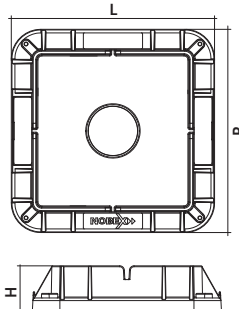

Sottobasetta ripartitrice di carico quadrata per ponteggi con foro centrale di stoccaggio diametro 51 e 4 canali di scarico dell'acqua posti lungo il foro di alloggiamento per la basetta metallica. Piatto centrale di appoggio rialzato e rinforzato con 4 speroni per lato. Inchiodabile ai 4 lati, impilabile e con griglia sottostante di ancoraggio. Catarinfrangente con sistema anti sganciamento indicato per l'utilizzo su terreni o dove sia richiesta al posto del tavolone alla base del montante. Certificata e personalizzabile.



Codice	Descrizione	H mm	L mm	P mm	Scatola singola	Imballo complessivo
NB50055	Sottobasetta STR 5 ripartitore carico	50	206	206	24 pz	-

CB - Coprigiunto basic



PRODOTTO CERTIFICATO

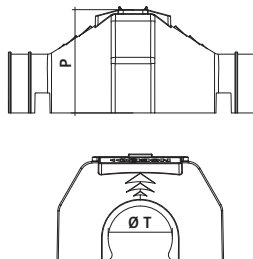
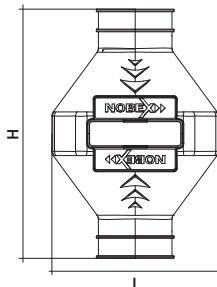

Coprigiunto poligonale di protezione e segnalazione del giunto sottostante. Doppio sistema di ancoraggio ad incastro alle due estremità con nervature di alloggiamento per eventuali fascette plastiche di legatura. Catarinfrangente con sistema antisganciamento. Articolo personalizzabile.



Codice	Descrizione	H mm	L mm	P mm	Ø T mm	Scatola singola	Imballo complessivo
NB50120	Coprigiunto CB poligonale di protezione e segnalazione del giunto sottostante	187	125	77,5	48	70 pz	-

ACCESSORI PER PONTEGGI IN POLIPROPILENE

APPLICAZIONI Edilizia e ponteggi.

CDM - Coprigiunto CDM doppio

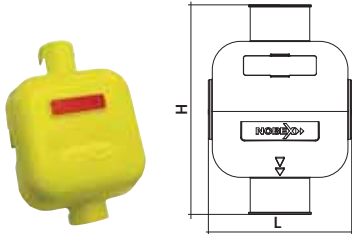

Codice	Descrizione	L mm	H mm	Scatola singola	Imballo complessivo
NB50130	Coprigiunto CDM doppio per multidirezione	95	275	20 pz	-

SCM - Sfera coprirosetta

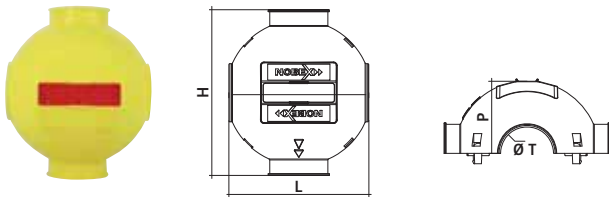

Sfera coprirosetta per ponteggi multidirezionali o come coprigiunto per montanti diametro 48 a croce. Nervature di alloggiamento per eventuale legatura aggiuntiva con fascette plastiche. Catarinfrangente con sistema antisganciamiento. Personalizzabile con doppio logo, indicazione del verso d'installazione e sistema con clip a incastro per la sfera.



Codice	Descrizione	H mm	L mm	P mm	Ø T mm	Scatola singola	Imballo complessivo
NB50135	Sfera coprirosetta SCM per ponteggi multidirezionali	160	135	69,5	51	15 pz	-

NGC 50 - Copritubo telescopico



Copritubo telescopico di segnalazione per i montanti del ponteggio, esterni ed interni, con 4 sistemi di aggancio a incastro, due centrali e due all'estremità, nervature di alloggiamento per eventuale legatura aggiuntive con fascette plastiche al centro e alle estremità. Articolo personalizzabile.

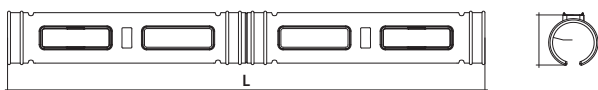

Codice	Descrizione	Ø E mm	Ø T mm	L mm	Scatola singola	Imballo complessivo
NB50148	Copritubo telescopico NGC 50 di segnalazione sottostante	56	48	490	50 pz	-

ACCESSORI PER PONTEGGI IN POLIPROPILENE

NCT - Copritubo ad innesto

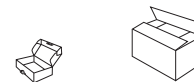

Codice	Descrizione	L mm	H mm	Scatola singola	Imballo complessivo
NB50145	Copritubo NCT ad innesto con catarifrangente	200	55	50 pz	-

TPE 48 - Tappo copritubo Ø 48

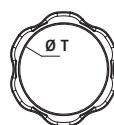
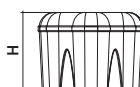

Tappo copritubo morbido in materiale gommoso, ergonomico sia sulla parte terminale sia sul corpo e con smussi per l'alloggiamento delle dita alla base del tappo. Articolo personalizzabile.

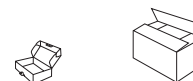

Codice	Descrizione	Ø T mm	H mm	Scatola singola	Imballo complessivo
NB50168	Tappo copritubo TPE 48 morbido in materiale gommoso	48	40	100 pz	-

FPR - Fungo di segnalazione rosso Ø 6-22

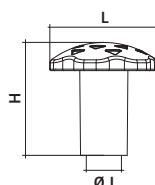

Fungo coprifermo di segnalazione ergonomico per tondini cm 6-22. Con nervature interne alla calotta e speroni interni al tubo centrale per l'ancoraggio dei tondini.

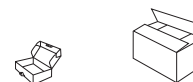

Codice	Descrizione	Ø I mm	H mm	L mm	Scatola singola	Imballo complessivo
NB50171	Fungo FPR segnalazione rosso Ø 6-22	6/22	60	59	250 pz	-

FPR - Fungo segnalazione rosso Ø 22-35 e tappo interno tubo Ø 48

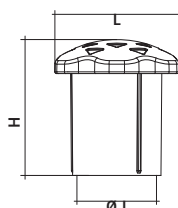
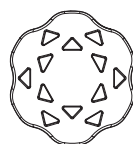

Fungo coprifermo di segnalazione ergonomico per tondini cm 22-35. Con nervature interne alla calotta e speroni interni al tubo centrale per l'ancoraggio dei tondini. Doppia funzione che gli consente di essere utilizzato anche come tappo interno copritubo di protezione e segnalazione.

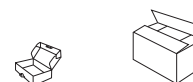

Codice	Descrizione	Ø I mm	H mm	L mm	Scatola singola	Imballo complessivo
NB50182	Fungo FPR segnalazione rosso Ø 22-35	22/35	60	56	250 pz	-

ACCESSORI PER PONTEGGI

APPLICAZIONI Ponteggi

CA-R - Coprigiunto antiurto in PE estruso pre pretagliato e valabile

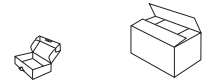

Codice	Descrizione	L m	Scatola singola	Imballo complessivo
NB50195	Coprigiunto CA-R antiurto in PE estruso 2,5 m rosso	2,5	10 pz	3 scatole
NB50196	Coprigiunto CA-R antiurto in PE estruso 2,5 m giallo	2,5	10 pz	3 scatole

NS 200 m - Nastro di segnalazione

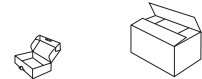

Codice	Descrizione	L m	H mm	Scatola singola	Imballo complessivo
NB50205	Nastro segnalazione NS 200 m H 7 mm	200	7	12 pz	-
NB50245	Nastro segnalazione adesivo NS 200 m H 7 mm	200	7	12 pz	-

NS-LV H10-200 m - Nastro "lavori in corso"

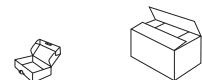

Codice	Descrizione	L m	H mm	Scatola singola	Imballo complessivo
NB50215	Nastro lavori in corso NS-LV 200 m H 10 mm	200	10	16 pz	-

SPINA VERMALE - Gancio di sicurezza per ponteggi prefabbricati Ø 48

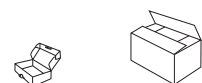

Codice	Descrizione	Ø	Scatola singola	Imballo complessivo
NB50423	Spina vermale Ø 6	6	200 pz	-
NB50430	Spina vermale Ø 8	8	200 pz	-
NB50435	Spina vermale Ø 10	10	200 pz	-

ACCESSORI PER PONTEGGI

BULLONE RICAMBIO - 1/2"x76 per giunti e morsetti

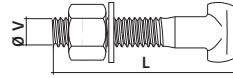

Codice	Descrizione	Ø V inch	L mm	Scatola singola	Imballo complessivo
NB50420	Bullone ricambio 1/2"x76 con dado e rondella testa tonda per giunti stampati	1/2	76	100 pz	-
NB50440	Bullone ricambio 1/2"x76 con dado e rondella testa piana per giunti forgiati	1/2	76	100 pz	-
NB50445	Bullone ricambio 1/2"x76 con dado e rondella testa piana per giunti forgiati	1/2	76	100 pz	-
NB50448	Dado di ricambio per bullone 1/2"	1/2		100 pz	-
NB50450	Dado flangiato di ricambio per bullone 1/2"	1/2		100 pz	-
NB50453	Vite testa a martello 1/2"x76	1/2	76	100 pz	-
NB50455	Vite testa a martello 1/2"x100	1/2	100	100 pz	-

SXP-ORD - Tassello in acciaio certificato con occhiolo a ricciolo per ancoraggio funi



Conformità
EN 1263

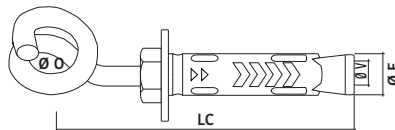

Codice	Descrizione	Ø V mm	Ø E mm	LC mm	Scatola singola	Imballo complessivo
NB99325	Passaggio fune SXP-ORD Ø 13 mm E 18	12	18	160	25 pz	-

OR-L - Occhiolo mordente per ancoraggi o funi



Conformità
EN 1263

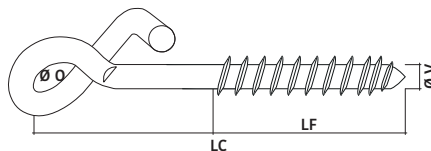

Si consiglia il tassello in nylon ABP 14x100 Cod. 53792 pag. 82

Codice	Descrizione	Ø mm	LF mm	LC mm	Scatola singola	Imballo complessivo
NB99330	Passaggio fune OR-L Ø 10x45 x 160	10	45	160	25 pz	-

LINEA SICUREZZA PER PONTEGGI - CHIAVI

CHP 21-22 - Chiave poligonale 21/22 in cromo vanadium

Codice	Descrizione	Scatola singola	Imballo complessivo
NB80122	Chiave poligonale CHP 21-22	1 pz	5 scatole

CHP-R 21-22 - Chiave poligonale 21/22 gommata

Codice	Descrizione	Scatola singola	Imballo complessivo
NB80128	Chiave poligonale CHP 21-22 gommata	1 pz	5 scatole

CCHC-C / CHC-NN - Chiave a cricchetto 21 - 22

Codice	Descrizione	Scatola singola	Imballo complessivo
NB80142	Chiave cricchetto CHC-C 21-22	1 pz	5 scatole
NB80143	Chiave cricchetto CHC-NN 21-22	1 pz	5 scatole

CHC-CR - Chiave a cricchetto 21 - 22 con occhiolo di ancoraggio ancoraggio per cintura

Codice	Descrizione	Scatola singola	Imballo complessivo
NB80148	Chiave cricchetto CHC-CR 21-22 gommata	1 pz	5 scatole

LINEA SICUREZZA PER PONTEGGI - CHIAVI

CHC-CN - Chiave a cricchetto 21/22 gommata parziale



Codice	Descrizione	Scatola singola	Imballo complessivo
NB80146	Chiave a cricchetto CHC-CN 21/22 gommata parziale	1 pz	5 scatole

Accessori per edilizia e ponteggi



**SECCHIELLI, BLISTER
E PUNTE**

BLISTER, BUCKET E PUNTE

MAXI BUCKET TOP FUN	184
BUCKET EMC ²	184
BUCKET NC	184
BUCKET A	185
BUCKET AB	186
BUCKET TOP FUN	186
BUCKET FUA	187
BUCKET TNSM	188
BUCKET TNB	189
BUCKET SXL-V	189
BUCKET AK	189
BUCKET TM-FL	190
BLISTER A/B	190
BLISTER NC	191
BLISTER TFN	192
BLISTER TOP	192
BLISTER AQ	193
BLISTER TNSM	193
BLISTER TNB	194
BLISTER AK	194
BLISTER TOP FUN	194
BLISTER FP 9	195
BLISTER AC	195
BLISTER FUA	196
BLISTER HAV	197
BLISTER SPV	197
BLISTER SPZ	197
BLISTER CPV	197
BLISTER V-FOSF	197
BLISTER SXP	198
BLISTER TM-FL	198
BLISTER NX	199
BLISTER SXL-V	199
BLISTER NTO	199
BLISTER NNB	200
BLISTER GN	200
BLISTER BR	200
BLISTER WC	201
BLISTER FCS	201
BLISTER NNB-CG	202
BLISTER SXLV-GL	202

Bucket

Gamma completa di bucket, composti da solo tassello, tassello e vite o tassello, vite e punte da muro disponibile in vari formati. La gamma comprende tasselli universali in plastica, universali in acciaio, tasselli a battuta e ancore.

MAXI BUCKET TOP FUN - Con tassello TOP FUN, livella tascabile e punta HM super



Codice	Descrizione	Contenuto bucket	Imballo complessivo
NB172151	Maxi bucket con tasselli in nylon TOP FUN Ø 9, punta HM super 9x120 mm e livella tascabile	200 pz	12 bucket
NB172168	Maxi bucket con tasselli in nylon TOP FUN Ø 12, punta HM super 12x120 mm e livella tascabile	150 pz	12 bucket

BUCKET EMC² - Con tassello bimatereale EMC² e vite TSP

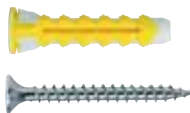

Codice	Descrizione	Contenuto bucket	Imballo complessivo
NB179206	Bucket con tasselli bimatereale EMC2 6x40 e vite TSP 3,5x50	300 pz	6 bucket
NB179208	Bucket con tasselli bimatereale EMC2 8x50 e vite TSP 4,5x60	150 pz	6 bucket

BUCKET NC - Con tassello in nylon NC



Codice	Descrizione	Contenuto bucket	Imballo complessivo
NB174092	Bucket con tasselli NC 6 in nylon 6x30	200 pz	8 bucket
NB174095	Bucket con tasselli NC 8 in nylon 8x40	150 pz	8 bucket
NB174098	Bucket con tasselli NC 10 in nylon 10x50	100 pz	8 bucket

BUCKET NCV - Con tassello in nylon NC e vite truciolare DIN 7505/A



Codice	Descrizione	Contenuto bucket	Imballo complessivo
NB174090	Bucket con tasselli NCV 5 in nylon 5x25 e vite TSP 4x30	250 pz	8 bucket
NB174094	Bucket con tasselli NCV 6 in nylon 6x30 e vite TSP 4,5x40	150 pz	8 bucket
NB174066	Bucket con tasselli NCV 6 in nylon 6x30 e vite TSP 4,5x40	300 pz	8 bucket
NB174100	Bucket con tasselli NCV 8 in nylon 8x40 e vite TSP 5x50	100 pz	8 bucket
NB174088	Bucket con tasselli NCV 8 in nylon 8x40 e vite TSP 5x50	150 pz	8 bucket
NB174105	Bucket con tasselli NCV 10 in nylon 10x50 e vite TSP 6x60	50 pz	8 bucket
NB174110	Bucket con tasselli NCV 10 in nylon 1x50 e vite TSP 6x60	75 pz	8 bucket

Bucket

BUCKET NCV-HMSU - Con tassello in nylon NC, vite truciolare, punta per muro HM-SU e punta SDS plus



Codice	Descrizione	Contenuto bucket	Imballo complessivo
NB209066	Bucket con tasselli NCV 6 in nylon 6x30 vite TSP 4,5x40 punta HM-SU e punta SDS plus	300 pz	8 bucket
NB209088	Bucket con tasselli NCV 8 in nylon 8x40 e vite TSP 5x50 punta HM-SU e punta SDS plus	150 pz	8 bucket
NB209099	Bucket con tasselli NCV 10 in nylon 10x50 e vite TSP 6x60 punta HM-SU e punta SDS plus	75 pz	8 bucket

BOX KIT NCV - Con tassello in nylon NC e vite truciolare DIN 7505/A



Codice	Descrizione	Contenuto box kit	Imballo complessivo
NB209506	Box kit con tasselli NCV 6 in nylon 6x30 e vite TSP 4,5x40	500 pz	6 box kit
NB209308	Box kit con tasselli NCV 8 in nylon 8x40 e vite TSP 5x50	300 pz	6 box kit

BUCKET A - Con tassello in nylon A senza bordo



Codice	Descrizione	Contenuto bucket	Imballo complessivo
NB72010	Bucket con tasselli A 6 in nylon 6x30	200 pz	8 bucket
NB72012	Bucket con tasselli A 8 in nylon 8x40	150 pz	8 bucket
NB72015	Bucket con tasselli A 10 in nylon 10x50	100 pz	8 bucket

BUCKET AV-TC - Con tassello in nylon A senza bordo e vite truciolare DIN 7505/A

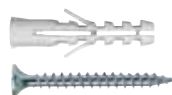

Codice	Descrizione	Contenuto bucket	Imballo complessivo
NB71963	Bucket con tasselli universali AV in nylon senza bordo 5x25 con vite TSP 4x30	200 pz	8 bucket
NB71970	Bucket con tasselli universali AV in nylon senza bordo 6x30 con vite TSP 4,5x40	150 pz	8 bucket
NB71987	Bucket con tasselli universali AV in nylon senza bordo 8x40 con vite TSP 5,0x45	100 pz	8 bucket
NB71994	Bucket con tasselli universali AV in nylon senza bordo 10x50 con vite TSP 6,0x60	50 pz	8 bucket

Bucket

BUCKET AB - Con tassello in nylon AB con bordo



Codice	Descrizione	Contenuto bucket	Imballo complessivo
NB72002	Bucket con tasselli AB 6 in nylon 6x30	200 pz	8 bucket
NB72004	Bucket con tasselli AB 8 in nylon 8x40	150 pz	8 bucket
NB72006	Bucket con tasselli AB 10 in nylon 10x50	100 pz	8 bucket

BUCKET AVB-TC - Con tassello in nylon AB con bordo e vite truciolare DIN 7505/A

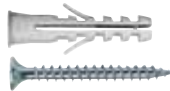

Codice	Descrizione	Contenuto bucket	Imballo complessivo
NB72007	Bucket con tasselli universali AVB 5 in nylon senza bordo 5x25 con vite TSP 4x30	200 pz	8 bucket
NB72014	Bucket con tasselli universali AVB 6 in nylon senza bordo 6x30 con vite TSP 4,5x40	150 pz	8 bucket
NB72021	Bucket con tasselli universali AVB 8 in nylon senza bordo 8x40 con vite TSP 5,0x45	100 pz	8 bucket
NB72038	Bucket con tasselli universali AVB 10 in nylon senza bordo 10x50 con vite TSP 6,0x60	50 pz	8 bucket

BUCKET TOP FUN-V - Tassello universale in nylon con vite metrica



Codice	Descrizione	Contenuto bucket	Imballo complessivo
NB72151	Bucket con tasselli in nylon TOP FUN-V 4 9x40 con vite metrica 4x45	50 pz	8 bucket
NB72168	Bucket con tassello in nylon TOP FUN-V 5 12x45 con vite metrica 4x50	50 pz	8 bucket

BUCKET TOP FUN-CG - Tassello universale in nylon con pitoneria - gancio corto



Codice	Descrizione	Contenuto bucket	Imballo complessivo
NB72175	Bucket con tasselli TOP FUN-GC 4 in nylon 9x40 con gancio corto 4x45	50 pz	8 bucket
NB72182	Bucket con tasselli TOP FUN-GC 5 in nylon 12x45 con gancio corto 5x50	40 pz	8 bucket

Bucket

BUCKET TOP FUN-GM - Tassello universale in nylon con pitoneria - gancio medio



Codice	Descrizione	Contenuto bucket	Imballo complessivo
NB72199	Bucket con tasselli TOP FUN-GM 4 in nylon 9x40 con gancio medio 4x45	50 pz	8 bucket
NB72205	Bucket con tasselli TOP FUN-GM 5 in nylon 12x45 con gancio medio 5x50	40 pz	8 bucket

BUCKET TOP FUN-OA - Tassello universale in nylon con pitoneria - occhio aperto



Codice	Descrizione	Contenuto bucket	Imballo complessivo
NB72212	Bucket con tasselli TOP FUN-OA 4 in nylon 9x40 con gancio occhio aperto	50 pz	8 bucket
NB72229	Bucket con tasselli TOP FUN-OA 5 in nylon 12x45 con gancio occhio aperto	40 pz	8 bucket

BUCKET TOP FUN-OC - Tassello universale in nylon con pitoneria - occhio chiuso



Codice	Descrizione	Contenuto bucket	Imballo complessivo
NB72236	Bucket con tasselli TOP FUN-OC 4 in nylon 9x40 con gancio occhio chiuso	50 pz	8 bucket
NB72243	Bucket con tasselli TOP FUN-OC 5 in nylon 12x45 con gancio occhio chiuso	40 pz	8 bucket

BUCKET FUA-V - Tassello universale in acciaio con vite metrica



Codice	Descrizione	Contenuto bucket	Imballo complessivo
NB72113	Bucket con tassello universale FUA-V in acciaio 9x40 con vite metrica 5x45	50 pz	8 bucket

BUCKET FUA-GC - Tassello universale in acciaio con pitoneria - gancio corto



Codice	Descrizione	Contenuto bucket	Imballo complessivo
NB72120	Bucket con tasselli universale FUA-GC in acciaio 9x40 con gancio corto 5x45	50 pz	8 bucket

Bucket

BUCKET FUA-GM - Tassello universale in acciaio con pitoneria - gancio medio



Codice	Descrizione	Contenuto bucket	Imballo complessivo
NB72137	Bucket con tasselli universale FUA-GM in acciaio 9x40 con gancio medio 5x45	50 pz	8 bucket

BUCKET FUA-OA - Tassello universale in acciaio con pitoneria - occhiolo aperto



Codice	Descrizione	Contenuto bucket	Imballo complessivo
NB72144	Bucket con tasselli FUA-OA in acciaio 9x40 con occhiolo aperto 5x45	400 pz	8 bucket

BUCKET TNSM-SV - Tassello rapido con bordo svasato in nylon vite zincata a battuta



Codice	Descrizione	Contenuto bucket	Imballo complessivo
NB72045	Bucket con tassello rapido TNSM-SV con bordo svasato in nylon 6x35 con vite zincata	100 pz	8 bucket
NB72052	Bucket con tassello rapido TNSM-SV con bordo svasato in nylon 6x40 con vite zincata	100 pz	8 bucket
NB72069	Bucket con tassello rapido TNSM-SV con bordo svasato in nylon 6x60 con vite zincata	50 pz	8 bucket
NB72076	Bucket con tassello rapido TNSM-SV con bordo svasato in nylon 6x80 con vite zincata	50 pz	8 bucket
NB72083	Bucket con tassello rapido TNSM-SV con bordo svasato in nylon 8x60 con vite zincata	50 pz	8 bucket
NB72090	Bucket con tassello rapido TNSM-SV con bordo svasato in nylon 8x80 con vite zincata	50 pz	8 bucket
NB72106	Bucket con tassello rapido TNSM-SV con bordo svasato in nylon 8x100 con vite zincata	50 pz	8 bucket

BOX KIT TNSM-SV - Tassello rapido con bordo svasato in nylon vite zincata a battuta



Codice	Descrizione	Contenuto box kit	Imballo complessivo
NB2090017	Box kit con tassello rapido TNSM-SV con bordo svasato in nylon 6x35 con vite zincata	300 pz	3 box kit
NB2090018	Box kit con tassello rapido TNSM-SV con bordo svasato in nylon 6x40 con vite zincata	300 pz	3 box kit

Bucket

BUCKET TNB - Tassello rapido in nylon a testa bombata con vite a battuta



Codice	Descrizione	Contenuto bucket	Imballo complessivo
NB73141	Bucket con tasselli TNB in nylon 5x25 con vite a battuta	200 pz	8 bucket
NB73158	Bucket con tasselli TNB in nylon 6x40 con vite a battuta	100 pz	8 bucket
NB209640	Bucket con tasselli TNB in nylon 6x40 con vite a battuta	200 pz	8 bucket

BUCKET SXL-V - Tassello in acciaio passante con vite TE 6.8



Codice	Descrizione	Contenuto bucket	Imballo complessivo
NB72311	Bucket con tasselli in acciaio passante SXL-V E8x45 con vite TE	50 pz	8 bucket
NB72328	Bucket con tassello in acciaio passante SXL-V E8x60 con vite TE	50 pz	8 bucket

BUCKET AK-V - Ancore in acciaio con vite

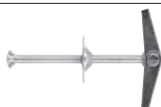

Codice	Descrizione	Contenuto bucket	Imballo complessivo
NB72397	Bucket con ancore AK-V in acciaio con vite M4	25 pz	8 bucket

AK-DD - Ancore in acciaio con doppio dado



Codice	Descrizione	Contenuto bucket	Imballo complessivo
NB72403	Bucket con ancore AK-DD in acciaio A con doppio dado M4	25 pz	8 bucket

AK-OA - Ancore in acciaio con occhiolo aperto



Codice	Descrizione	Contenuto bucket	Imballo complessivo
NB72427	Bucket con ancore AK-OA in acciaio con occhiolo aperto M4	25 pz	8 bucket

Bucket

AK-OC - Ancore in acciaio con occhio chiuso



Codice	Descrizione	Contenuto bucket	Imballo complessivo
NB72410	Bucket con ancore AK-OC in acciaio con occhio chiuso M4	25 pz	8 bucket

BUCKET TM-FL - Tasselli in acciaio passante



Codice	Descrizione	Contenuto bucket	Imballo complessivo
NB72373	Bucket con tassello in acciaio passante TM-FL 8x75	20 pz	8 bucket
NB72380	Bucket con tassello in acciaio passante TM-FL 10x90	20 pz	8 bucket

Blister

Gamma completa di blister, composti da solo tassello, tassello e vite o tassello vite e punta HM. La gamma comprende tasselli universali in plastica, universali in acciaio, tasselli a battuta e viteria.

BLISTER A - Con tassello in nylon A senza bordo



Codice	Descrizione	Contenuto blister	Imballo complessivo
NB21715	Blister con tasselli A 5 in nylon 5x25	40 pz	20 blister
NB21722	Blister con tasselli A 6 in nylon 6x30	40 pz	14 blister
NB21739	Blister con tasselli A 8 in nylon 8x40	30 pz	10 blister
NB21746	Blister con tasselli A 10 in nylon 10x50	15 pz	10 blister

BLISTER AV-TC - Con tassello in nylon A senza bordo e vite truciolare DIN 7505/A



Codice	Descrizione	Contenuto blister	Imballo complessivo
NB21753	Blister con tasselli universali AV in nylon senza bordo 5x25 con vite TSP 4x30	20 pz	20 blister
NB21760	Blister con tasselli universali AV in nylon senza bordo 6x30 con vite TSP 4,5x40	15 pz	14 blister
NB21777	Blister con tasselli universali AV in nylon senza bordo 8x40 con vite TSP 5,0x45	10 pz	14 blister
NB21784	Blister con tasselli universali AV in nylon senza bordo 10x50 con vite TSP 6,0x60	6 pz	14 blister

BLISTER AV-TC-HM - Con tassello in nylon A senza bordo, vite truciolare e punta HM-SU



Codice	Descrizione	Contenuto blister	Imballo complessivo
NB21814	Blister con tasselli universali AV in nylon senza bordo 5x25 con vite TSP 4x30 e punta HM-SU	20 pz	20 blister
NB21821	Blister con tasselli universali AV in nylon senza bordo 6x30 con vite TSP 4,5x40 e punta HM-SU	10 pz	20 blister
NB21838	Blister con tasselli universali AV in nylon senza bordo 8x40 con vite TSP 5,0x45 e punta HM-SU	16 pz	14 blister

BLISTER AV-TE - Con tassello in nylon A senza bordo e tirafondo



Codice	Descrizione	Contenuto blister	Imballo complessivo
NB21807	Blister con tasselli universali AV in nylon senza bordo 8x40 con tirafondo 6x45	6 pz	20 blister
NB21791	Blister con tasselli universali AV in nylon senza bordo 10x50 con tirafondo 7x60	4 pz	14 blister
NB71765	Blister con tasselli universali AV in nylon senza bordo 12x60 con tirafondo 10x60	2 pz	10 blister

BLISTER AVB-TC - Con tassello in nylon AB con bordo e vite truciolare DIN 7505/A



Codice	Descrizione	Contenuto blister	Imballo complessivo
NB71529	Blister con tasselli universali AVB 5 in nylon senza bordo 5x25 con vite TSP 4x30	20 pz	20 blister
NB71536	Blister con tasselli universali AVB 6 in nylon senza bordo 6x30 con vite TSP 4,5x40	15 pz	14 blister
NB71543	Blister con tasselli universali AVB 8 in nylon senza bordo 8x40 con vite TSP 5,0x45	10 pz	14 blister
NB71550	Blister con tasselli universali AVB 10 in nylon senza bordo 10x50 con vite TSP 6,0x60	6 pz	14 blister

BLISTER NC - Con tassello in nylon NC



Codice	Descrizione	Contenuto blister	Imballo complessivo
NB174040	Blister con tasselli NC 5 in nylon 5x25	30 pz	20 blister
NB174042	Blister con tasselli NC 6 in nylon 6x30	30 pz	10 blister
NB174044	Blister con tasselli NC 8 in nylon 8x40	20 pz	10 blister
NB174046	Blister con tasselli NC 10 in nylon 10x50	10 pz	10 blister

BLISTER NCV - Con tassello in nylon NC e vite truciolare DIN 7505/A



Codice	Descrizione	Contenuto blister	Imballo complessivo
NB174050	Blister con tasselli NCV 5 in nylon 5x25 e vite TSP 4x30	20 pz	20 blister
NB174063	Blister con tasselli NCV 6 in nylon 6x30 e vite TSP 4,5x40	15 pz	14 blister
NB174070	Blister con tasselli NCV 8 in nylon 8x40 e vite TSP 5x50	10 pz	14 blister
NB174087	Blister con tasselli NCV 10 in nylon 10x50 e vite TSP 6x60	6 pz	14 blister

Blister

BLISTER NCV-HM - Con tassello in nylon NC, vite truciolare e punta HM-SU



Codice	Descrizione	Contenuto blister	Imballo complessivo
NB174010	Blister con tasselli NCV 5 in nylon 5x25 con vite TSP 4x30 e punta HM-SU	20 pz	20 blister
NB174012	Blister con tasselli NCV 6 in nylon 6x30 con vite TSP 4,5x40 e punta HM-SU	10 pz	20 blister
NB174014	Blister con tasselli NCV 8 in nylon 8x40 con vite TSP 5x50 e punta HM-SU	6 pz	14 blister

BLISTER NCV-TE - Con tassello in nylon NC e tirafondo



Codice	Descrizione	Contenuto blister	Imballo complessivo
NB174018	Blister con tasselli NCV 8 in nylon 5x25 e tirafondo 5x50	6 pz	14 blister
NB174020	Blister con tasselli NCV 10 in nylon 6x30 e tirafondo 6x60	4 pz	14 blister
NB174022	Blister con tasselli NCV 12 in nylon 8x40 e tirafondo 8x70	4 pz	14 blister

BLISTER NC6 - Con tassello in nylon NC e pitoneria



Codice	Descrizione	Contenuto blister	Imballo complessivo
NB174024	Blister con tasselli NCV 6 in nylon 6x30 e gancio corto	10 pz	20 blister
NB174028	Blister con tasselli NCV 6 in nylon 6x30 e gancio medio	10 pz	20 blister
NB174032	Blister con tasselli NCV 6 in nylon 6x30 e occhio aperto	8 pz	20 blister
NB174036	Blister con tasselli NCV 6 in nylon 6x30 e occhio chiuso	8 pz	20 blister

BLISTER TFN-V - Con tassello in nylon per forati e lastre con vite truciolare DIN 7505/A



Codice	Descrizione	Contenuto blister	Imballo complessivo
NB69038	Blister con tasselli universale in nylon TFN-V 6 con vite TSP 3,5x45	10 pz	20 blister
NB69045	Blister con tasselli universale in nylon TFN-V 8 con vite TSP 4,5x60	10 pz	14 blister
NB69052	Blister con tasselli universale in nylon TFN-V 10 con vite TSP 6x80	6 pz	10 blister

BLISTER TOP-CB - Con tassello universale in polipropilene



Codice	Descrizione	Contenuto blister	Imballo complessivo
NB22033	Blister con tasselli universale TOP-CB in polipropilene 6x38	15 pz	20 blister
NB22040	Blister con tasselli universale TOP-CB in polipropilene 8x51	10 pz	20 blister
NB22057	Blister con tasselli universale TOP-CB in polipropilene 10x60	6 pz	14 blister

BLISTER TOP-V CB - Con tassello in polipropilene con vite truciolare DIN 7505/A

Codice	Descrizione	Contenuto blister	Imballo complessivo
NB22002	Blister con tasselli universali TOP-V CB in polipropilene 6x38 con vite TSP 4x50	10 pz	14 blister
NB22019	Blister con tasselli universali TOP-V CB in polipropilene 8x51 con vite TSP 5x60	10 pz	10 blister
NB22026	Blister con tasselli universali TOP-V CB in polipropilene 10x60 con vite TSP 6x70	6 pz	14 blister

BLISTER AQ - Con tassello AV con gancio appendiquadro

Codice	Descrizione	Contenuto blister	Imballo complessivo
NB21848	Blister con tasselli AQ in nylon senza bordo in nylon con cancano	10 pz	20 blister
NB21850	Blister con tasselli AQ in nylon senza bordo in nylon con cancano	20 pz	20 blister
NB21852	Blister con tasselli AQ in nylon senza bordo in nylon con cancano	30 pz	20 blister

BLISTER TNSM-BTS - Con tassello rapido bordo svasato in nylon per zoccolini e battiscopa

Codice	Descrizione	Contenuto blister	Imballo complessivo
NB71567	Blister con tasselli rapido bordo svasato TNSM-BTS 4x30 in nylon per zoccolini e battiscopa	30 pz	14 blister

BLISTER TNSM-SV - Tassello rapido con bordo svasato in nylon vite zincata a battuta

Codice	Descrizione	Contenuto blister	Imballo complessivo
NB69182	Blister con tassello rapido TNSM-SV con bordo svasato in nylon 6x35 con vite zincata	100 pz	8 blister
NB72434	Blister con tassello rapido TNSM-SV con bordo svasato in nylon 6x40 con vite zincata	100 pz	8 blister
NB69199	Blister con tassello rapido TNSM-SV con bordo svasato in nylon 6x60 con vite zincata	50 pz	8 blister
NB69205	Blister con tassello rapido TNSM-SV con bordo svasato in nylon 6x80 con vite zincata	50 pz	8 blister
NB69212	Blister con tassello rapido TNSM-SV con bordo svasato in nylon 8x60 con vite zincata	50 pz	8 blister
NB69229	Blister con tassello rapido TNSM-SV con bordo svasato in nylon 8x80 con vite zincata	50 pz	8 blister

Blister

BLISTER TNB- Tassello passante in nylon a testa bombata con vite a battuta



Codice	Descrizione	Contenuto blister	Imballo complessivo
NB22415	Blister con tasselli TNB in nylon 6x25 con vite a battuta	6 pz	20 blister
NB22422	Blister con tasselli TNB in nylon 6x40 con vite a battuta	6 pz	20 blister
NB22439	Blister con tasselli TNB in nylon 6x50 con vite a battuta	6 pz	14 blister
NB22446	Blister con tasselli TNB in nylon 6x60 con vite a battuta	6 pz	14 blister

BLISTER AK - Ancore in acciaio con vite M4



AK-V



AK-DD



AK-OC



AK-OA

Per schede tecniche vedi articoli AK pag. 70-71

Codice	Descrizione	Contenuto blister	Imballo complessivo
NB22125	Blister con ancora AK-V in acciaio con vite M4	2 pz	14 blister
NB22132	Blister con ancora AK-DD in acciaio con vite M4	2 pz	14 blister
NB22149	Blister con ancora AK-OC in acciaio con vite M4	2 pz	14 blister
NB22156	Blister con ancora AK-OA in acciaio con vite M4	2 pz	14 blister

BLISTER TOP FUN-V - Tassello universale in nylon con vite metrica



Codice	Descrizione	Contenuto blister	Imballo complessivo
NB22576	Blister con tasselli in nylon TOP FUN-V 4 9x40 con vite metrica 4x45	6 pz	14 blister
NB22583	Blister con tassello in nylon TOP FUN-V 5 12x45 con vite metrica 4x50	4 pz	10 blister

BLISTER TOP FUN-CG - Tassello universale in nylon con pitoneria - gancio corto



Codice	Descrizione	Contenuto bucket	Imballo complessivo
NB22613	Blister con tasselli in nylon TOP FUN-GC 4 9x40 con vite metrica 4x45	6 pz	14 bucket
NB22590	Blister con tassello in nylon TOP FUN-GC 5 12x45 con vite metrica 4x50	4 pz	10 bucket

BLISTER TOP FUN-GM - Tassello universale in nylon con pitoneria - gancio medio



Codice	Descrizione	Contenuto blister	Imballo complessivo
NB22620	Blister con tasselli TOP FUN-GM 4 in nylon 9x40 con gancio medio 4x45	6 pz	14 blister
NB22606	Blister con tasselli TOP FUN-GM 5 in nylon 12x45 con gancio medio 5x50	4 pz	10 blister

Blister

BLISTER TOP FUN-OA - Tassello universale in nylon con pitoneria - occhio aperto



Codice	Descrizione	Contenuto blister	Imballo complessivo
NB22651	Blister con tasselli TOP FUN-OA 4 in nylon 9x40 con gancio occhio aperto	6 pz	10 blister
NB22668	Blister con tasselli TOP FUN-OA 5 in nylon 12x45 con gancio occhio aperto	2 pz	10 blister

BLISTER TOP FUN-OC - Tassello universale in nylon con pitoneria - occhio chiuso



Codice	Descrizione	Contenuto blister	Imballo complessivo
NB22675	Blister con tasselli TOP FUN-OC 4 in nylon 9x40 con gancio occhio chiuso	6 pz	10 blister
NB22682	Blister con tasselli TOP FUN-OC 5 in nylon 12x45 con gancio occhio chiuso	2 pz	10 blister

BLISTER TOP FUN-DD - Tassello universale in nylon con vite metrica e doppio dado



Codice	Descrizione	Contenuto blister	Imballo complessivo
NB22699	Blister con tasselli TOP FUN-DD 4 in nylon 9x40 con vite metrica e doppio dado	4 pz	10 blister
NB22705	Blister con tasselli TOP FUN-DD 5 in nylon 12x45 con vite metrica e doppio dado	2 pz	10 blister

BLISTER FP 9 - Paracolpi in PVC con tassello FUN-V ø 9 universale in nylon e vite metrica



Codice	Descrizione	Contenuto blister	Imballo complessivo
NB22767	Blister con paracolpi in PVC FP 9 colore bianco	2 pz	10 blister
NB22774	Blister con paracolpi in PVC FP 9 colore nero	2 pz	10 blister
NB22804	Blister con paracolpi in PVC FP 9 colore marrone	2 pz	10 blister

BLISTER AC - Tassello mini in acciaio con vite o pitoneria metrica



AC-V

AC-G

AC-O

Per schede tecniche vedi articoli AC pag. 63

Codice	Descrizione	Contenuto blister	Imballo complessivo
NB21876	Blister con tassello mini AC-V 3x30 in acciaio con vite metrica	10 pz	20 blister
NB21883	Blister con tassello mini AC-G 3x30 in acciaio con vite metrica	10 pz	20 blister
NB21890	Blister con tassello mini AC-O 3x30 in acciaio con vite metrica	10 pz	20 blister

Blister

BLISTER FUA-V - Tassello universale in acciaio con vite metrica

Codice	Descrizione	Contenuto blister	Imballo complessivo
NB23009	Blister con tassello universale FUA-V in acciaio 9x40 con vite metrica 5x45	6 pz	10 blister

BLISTER FUA-GC - Tassello universale in acciaio con pitoneria - gancio corto

Codice	Descrizione	Contenuto blister	Imballo complessivo
NB23023	Blister con tasselli universale FUA-GC in acciaio 9x40 con gancio corto 5x45	4 pz	10 blister

BLISTER FUA-GM - Tassello universale in acciaio con pitoneria - gancio medio

Codice	Descrizione	Contenuto blister	Imballo complessivo
NB23047	Blister con tasselli universale FUA-GM in acciaio 9x40 con gancio medio 5x45	4 pz	10 blister

BLISTER FUA-OA - Tassello universale in acciaio con pitoneria - occhio aperto

Codice	Descrizione	Contenuto blister	Imballo complessivo
NB23085	Blister con tasselli FUA-OA in acciaio 9x40 con occhio aperto 5x45	4 pz	10 blister

BLISTER FUA-OC - Tassello universale in acciaio con pitoneria - occhio chiuso

Codice	Descrizione	Contenuto blister	Imballo complessivo
NB23108	Blister con tasselli FUA-OC in acciaio 9x40 con occhio chiuso 5x45	4 pz	10 blister

BLISTER FUA-DD - Tassello universale in acciaio con vite metrica e doppio dado

Codice	Descrizione	Contenuto blister	Imballo complessivo
NB23122	Blister con tasselli FUA-DD in acciaio 9x40 con vite metrica 5x80 e doppio dado	2 pz	10 blister

Blister

BLISTER HAV - Ancorante in nylon non passante per carichi leggeri



Codice	Descrizione	Contenuto blister	Imballo complessivo
NB22064	Blister con ancorante HAV in nylon non passante 10x38	4 pz	14 blister
NB22071	Blister con ancorante HAV in nylon non passante 17x47	4 pz	14 blister
NB22088	Blister con ancorante HAV-V in nylon non passante 10x38 con vite TSP 4x50	4 pz	14 blister
NB22095	Blister con ancorante HAV-V in nylon non passante 17x47 con vite TSP 4x50	4 pz	14 blister

BLISTER SPV - Tassello autoforante in nylon per cartongesso con vite DIN 7505/A



Codice	Descrizione	Contenuto blister	Imballo complessivo
NB22217	Blister con tassello autoforante in nylon SPV 6x37 con vite TSP 4x30	5 pz	20 blister

BLISTER SPZ - Tassello autoforante in zamak per cartongesso con vite DIN 7505/A



Codice	Descrizione	Contenuto blister	Imballo complessivo
NB22224	Blister con tassello autoforante in zamak SPZ 6x37 con vite TSP 4,5x40	5 pz	20 blister

BLISTER CPV - Tassello in acciaio con vite bombata Pozi



Codice	Descrizione	Contenuto blister	Imballo complessivo
NB69267	Blister con tassello CPV in acciaio 9x65 con vite bombata 5x70	2 pz	14 blister
NB69274	Blister con tassello CPV in acciaio 10x52 con vite bombata 6x57	2 pz	14 blister
NB69281	Blister con tassello CPV in acciaio 10x65 con vite bombata 6x70	2 pz	14 blister

BLISTER V-FOSF - Vite fosfatata con punta chiodo impronta Philips PH 2



Codice	Descrizione	Contenuto blister	Imballo complessivo
NB69298	Blister con vite fosfatata V-FOSF 3,5x25 punta chiodo	30 pz	20 blister
NB69300	Blister con vite fosfatata V-FOSF 3,5x25 punta chiodo	100 pz	14 blister
NB69302	Blister con vite fosfatata V-FOSF 3,5x25 punta chiodo	150 pz	10 blister
NB69304	Blister con vite fosfatata V-FOSF 3,5x25 punta chiodo	25 pz	20 blister
NB69308	Blister con vite fosfatata V-FOSF 3,5x25 punta chiodo	100 pz	10 blister
NB69312	Blister con vite fosfatata V-FOSF 3,5x25 punta chiodo	50 pz	10 blister

Blister

BLISTER SXP-B - Tasselli in acciaio non passante completi di vite TE 8.8 e rondella



Codice	Descrizione	Contenuto blister	Imballo complessivo
NB69106	Blister con tassello in acciaio non passante SXP-B 6x45 E10 con vite TE e rondella	2 pz	14 blister
NB69137	Blister con tassello in acciaio non passante SXP-B 8x50 E12 con vite TE e rondella	2 pz	14 blister
NB69151	Blister con tassello in acciaio non passante SXP-B 10x60 E14 con vite TE e rondella	2 pz	14 blister

BLISTER SXP-P - Tasselli in acciaio passante con distanziale, rondella e vite TE 8.8



Codice	Descrizione	Contenuto blister	Imballo complessivo
NB69113	Blister con tasselli in acciaio passante SXP-P M6x65 E10 con distanziale, rondella e vite TE	2 pz	14 blister
NB69144	Blister con tasselli in acciaio passante SXP-P M8x70 E12 con distanziale, rondella e vite TE	2 pz	14 blister

BLISTER SXP-OA - Tasselli in acciaio non passante con occhiolo aperto stampato a freddo



Codice	Descrizione	Contenuto blister	Imballo complessivo
NB71611	Blister con tasselli in acciaio passante SXP-OA M6x45 E10 occhiolo aperto	2 pz	14 blister
NB71628	Blister con tasselli in acciaio passante SXP-OA M8x50 E12 occhiolo aperto	2 pz	14 blister

BLISTER SXP-OC - Tasselli in acciaio passante con occhiolo chiuso stampato a freddo



Codice	Descrizione	Contenuto blister	Imballo complessivo
NB71598	Blister con tassello in acciaio passante SXP-OC M6x45 occhiolo aperto	2 pz	14 blister
NB71604	Blister con tassello in acciaio passante SXP-OC M8x50 occhiolo aperto	2 pz	14 blister

BLISTER TM-FL - Tasselli in acciaio passante



Codice	Descrizione	Contenuto blister	Imballo complessivo
NB23930	Blister con tasselli in acciaio passante TM-FL 6x60	4 pz	14 blister
NB23932	Blister con tasselli in acciaio passante TM-FL 6x80	4 pz	14 blister
NB23934	Blister con tasselli in acciaio passante TM-FL 8x75	4 pz	14 blister
NB23936	Blister con tasselli in acciaio passante TM-FL 8x90	4 pz	14 blister
NB23938	Blister con tasselli in acciaio passante TM-FL 10x90	4 pz	14 blister
NB23940	Blister con tasselli in acciaio passante TM-FL 10x100	4 pz	14 blister
NB23942	Blister con tasselli in acciaio passante TM-FL 12x90	4 pz	14 blister
NB23944	Blister con tasselli in acciaio passante TM-FL 12x110	4 pz	14 blister

Blister

BLISTER NX-B - Tasselli in acciaio non passante con vite TE 8.8 e rondella



Codice	Descrizione	Contenuto blister	Imballo complessivo
NB23405	Blister con tasselli in acciaio non passante NX-B M6x60 E12 con vite TE 8.8 e rondella	2 pz	14 blister
NB23412	Blister con tasselli in acciaio non passante NX-B M8x70 E14 con vite TE 8.8 e rondella	2 pz	14 blister
NB23414	Blister con tasselli in acciaio non passante NX-B M10x80 E16 con vite TE 8.8 e rondella	2 pz	14 blister

BLISTER NX-OC - Tasselli in acciaio con pitoneria occhiolo chiuso stampato a freddo



Codice	Descrizione	Contenuto blister	Imballo complessivo
NB23450	Blister con tasselli in acciaio non passante NX-B M6x60 con vite TE 8.8 e rondella	2 pz	14 blister
NB23467	Blister con tasselli in acciaio non passante NX-B M8x70 con vite TE 8.8 e rondella	2 pz	14 blister

BLISTER NX-OA - Tasselli in acciaio non passante con occhiolo aperto



Codice	Descrizione	Contenuto blister	Imballo complessivo
NB23481	Blister con tasselli in acciaio non passante NX-OA M6x45 occhiolo aperto	2 pz	14 blister
NB23498	Blister con tasselli in acciaio non passante NX-OA M8x55 occhiolo aperto	2 pz	14 blister

BLISTER SXL-V - Tassello in acciaio passante con vite TE 6.8



Codice	Descrizione	Contenuto blister	Imballo complessivo
NB23238	Blister con tasselli in acciaio passante SXL-V E8x45 con vite TE	4 pz	14 blister
NB23245	Blister con tasselli in acciaio passante SXL-V E8x60 con vite TE	2 pz	14 blister
NB23276	Blister con tasselli in acciaio passante SXL-V E10x60 con vite TE	2 pz	14 blister

BLISTER NTO - Tassello in ottone godronato per medie portate



Codice	Descrizione	Contenuto blister	Imballo complessivo
NB69172	Blister con tasselli in ottone NTO M 5x20 E 6,5	10 pz	20 blister
NB69174	Blister con tasselli in ottone NTO M 6x23 E 8	10 pz	20 blister
NB69176	Blister con tasselli in ottone NTO M 8x28 E 10	8 pz	20 blister
NB69178	Blister con tasselli in ottone NTO M 10x32 E 12	6 pz	20 blister

Blister

BLISTER NNB - Tassello passante in nylon con nottolino zincato



Codice	Descrizione	Contenuto blister	Imballo complessivo
NB71633	Blister con tasselli passante in nylon NNB 8x70 E12	4 pz	14 blister
NB71640	Blister con tasselli passante in nylon NNB 10x75 E14	4 pz	10 blister

BLISTER GN - Gabbietta in polipropilene per fissaggio chimico su laterizi forati e cappotti



Codice	Descrizione	Contenuto blister	Imballo complessivo
NB71826	Blister con gabbietta in polipropilene singola GN 15x85 per fissaggio chimico	2 pz	14 blister

BLISTER BR - Barrette filettate con dado e rondella. Classe di resistenza 4.8



Codice	Descrizione	Contenuto blister	Imballo complessivo
NB71864	Blister con barretta filettata BR 6x60 con dado e rondella	6 pz	20 blister
NB71871	Blister con barretta filettata BR 8x100 con dado e rondella	4 pz	20 blister
NB71888	Blister con barretta filettata BR 10x110 con dado e rondella	4 pz	14 blister

BLISTER WC - Tasselli in nylon per vasi e bidet con vite in ottone TE



Codice	Descrizione	Contenuto blister	Imballo complessivo
NB23948	Blister con tasselli in nylon WC 10x50 con vite TE 6x80 in ottone	2 pz	14 blister

BLISTER FCS - Tasselli in nylon con codetta per fissaggio scaldabagni



Codice	Descrizione	Contenuto blister	Imballo complessivo
NB71673	Blister con tasselli in nylon FCS 10x60 con codetta 8x70	2 pz	10 blister

BLISTER NNB-CG - Tassello in nylon passante con codette per fissaggio scaldabagno

Codice	Descrizione	Contenuto blister	Imballo complessivo
NB24044	Blister con tasselli in nylon passante NNB-CG 14x95 con codette	2 pz	10 blister

BLISTER SXLV-GL - Tassello per fissaggio scaldabagni e caldaie con codetta a L

Codice	Descrizione	Contenuto blister	Imballo complessivo
NB69168	Blister con tasselli SXLV-GL 10x80 E12 con codetta a L	2 pz	10 blister

PUNTE DA TRAPANO

PUNTE DA TRAPANO

HSS FRESATE - COBALTO	204-207
HM SUPER	208
SDS-PLUS	209
SDS-MAX	210
ACCESSORI E SCALPELLI	211
FRESE E ACCESSORI	212-214
PEL	215
BIT e ACCESSORI	215-216

Punte per metalli

Punte in acciaio HSS di elevata qualità, DIN 338 cilindriche.

Disponibili in variante rullata o fresata, con acciai HSS , HSS cobalto 5% e HSS cobalto 8% per i materiali con resistenza più elevata.

MATERIALI DI SUPPORTO Tutti i tipi di metalli

HSS - Punta elicoidale cilindrica rullata per forare tutti i tipi di metallo DIN 338 serie corta

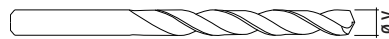

indicata per Ferro, Acciaio dolce, Acciaio legato, Metalli leggeri e plastica



Codice	Descrizione	Ø P mm	Scatola singola	Imballo complessivo
NB40419	Punta elicoidale cilindrica HSS 1 mm rullata	1	10 pz	10 scatole
NB40420	Punta elicoidale cilindrica HSS 1,25 mm rullata	1,25	10 pz	10 scatole
NB40422	Punta elicoidale cilindrica HSS 1,5 mm rullata	1,5	10 pz	10 scatole
NB40424	Punta elicoidale cilindrica HSS 1,75 mm rullata	1,75	10 pz	10 scatole
NB40426	Punta elicoidale cilindrica HSS 2 mm rullata	2	10 pz	10 scatole
NB40428	Punta elicoidale cilindrica HSS 2,25 mm rullata	2,25	10 pz	10 scatole
NB40430	Punta elicoidale cilindrica HSS 2,5 mm rullata	2,5	10 pz	10 scatole
NB40432	Punta elicoidale cilindrica HSS 2,75 mm rullata	2,75	10 pz	10 scatole
NB40433	Punta elicoidale cilindrica HSS 3 mm rullata	3	10 pz	10 scatole
NB42598	Punta elicoidale cilindrica HSS 3,25 mm rullata	3,25	10 pz	10 scatole
NB42604	Punta elicoidale cilindrica HSS 3,50 mm rullata	3,50	10 pz	10 scatole
NB42611	Punta elicoidale cilindrica HSS 3,75 mm rullata	3,25	10 pz	10 scatole
NB40440	Punta elicoidale cilindrica HSS 4 mm rullata	4	10 pz	10 scatole
NB42628	Punta elicoidale cilindrica HSS 4,25 mm rullata	4,25	10 pz	10 scatole
NB42635	Punta elicoidale cilindrica HSS 4,5 mm rullata	4,5	10 pz	10 scatole
NB42642	Punta elicoidale cilindrica HSS 4,75 mm rullata	4,75	10 pz	10 scatole
NB40457	Punta elicoidale cilindrica HSS 5 mm rullata	4,5	10 pz	10 scatole
NB42659	Punta elicoidale cilindrica HSS 5,25 mm rullata	5,25	10 pz	10 scatole
NB42666	Punta elicoidale cilindrica HSS 5,5 mm rullata	5,5	10 pz	10 scatole
NB42668	Punta elicoidale cilindrica HSS 5,75 mm rullata	5,75	10 pz	10 scatole
NB40464	Punta elicoidale cilindrica HSS 6 mm rullata	6	10 pz	10 scatole
NB42680	Punta elicoidale cilindrica HSS 6,25 mm rullata	6,25	10 pz	10 scatole
NB42697	Punta elicoidale cilindrica HSS 6,5 mm rullata	6,5	10 pz	10 scatole
NB42703	Punta elicoidale cilindrica HSS 6,75 mm rullata	6,75	10 pz	10 scatole
NB40471	Punta elicoidale cilindrica HSS 7 mm rullata	7	10 pz	10 scatole
NB42710	Punta elicoidale cilindrica HSS 7,25 mm rullata	7,25	10 pz	10 scatole
NB42727	Punta elicoidale cilindrica HSS 7,5 mm rullata	7,5	10 pz	10 scatole
NB42734	Punta elicoidale cilindrica HSS 7,75 mm rullata	7,75	10 pz	10 scatole
NB40488	Punta elicoidale cilindrica HSS 8 mm rullata	8	10 pz	10 scatole
NB42741	Punta elicoidale cilindrica HSS 8,25 mm rullata	8,25	10 pz	10 scatole
NB42758	Punta elicoidale cilindrica HSS 8,5 mm rullata	8,5	10 pz	10 scatole
NB42765	Punta elicoidale cilindrica HSS 8,75 mm rullata	8,75	10 pz	10 scatole
NB40495	Punta elicoidale cilindrica HSS 9 mm rullata	9	10 pz	10 scatole
NB42772	Punta elicoidale cilindrica HSS 9,25 mm rullata	9,25	10 pz	10 scatole
NB42789	Punta elicoidale cilindrica HSS 9,5 mm rullata	9,5	10 pz	10 scatole
NB42796	Punta elicoidale cilindrica HSS 9,75 mm rullata	9,75	10 pz	10 scatole
NB40501	Punta elicoidale cilindrica HSS 10 mm rullata	10	10 pz	10 scatole
NB42819	Punta elicoidale cilindrica HSS 10,5 mm rullata	10,5	5 pz	5 scatole
NB40518	Punta elicoidale cilindrica HSS 11 mm rullata	11	5 pz	5 scatole
NB42840	Punta elicoidale cilindrica HSS 11,5 mm rullata	11,5	5 pz	5 scatole
NB40525	Punta elicoidale cilindrica HSS 12 mm rullata	12	5 pz	5 scatole
NB42871	Punta elicoidale cilindrica HSS 12,5 mm rullata	12,5	5 pz	5 scatole
NB40532	Punta elicoidale cilindrica HSS 13 mm rullata	13	5 pz	5 scatole

HSS FRESATA - Punta elicoidale cilindrica fresata, interamente rettificata DIN 338

indicata per Metalli, Metalli leggeri, Acciaio dolce, Acciaio legato, Ghisa

Codice	Descrizione	Ø P mm	Scatola singola	Imballo complessivo
NB40827	Punta elicoidale cilindrica HSS 0,5 mm fresata	0,5	10 pz	10 scatole
NB40829	Punta elicoidale cilindrica HSS 0,6 mm fresata	0,6	10 pz	10 scatole
NB40831	Punta elicoidale cilindrica HSS 0,7 mm fresata	0,7	10 pz	10 scatole
NB40833	Punta elicoidale cilindrica HSS 0,8 mm fresata	0,8	10 pz	10 scatole
NB40835	Punta elicoidale cilindrica HSS 0,9 mm fresata	0,9	10 pz	10 scatole
NB40837	Punta elicoidale cilindrica HSS 1 mm fresata	1	10 pz	10 scatole
NB40843	Punta elicoidale cilindrica HSS 1,25 mm fresata	1,25	10 pz	10 scatole
NB40845	Punta elicoidale cilindrica HSS 1,5 mm fresata	1,5	10 pz	10 scatole
NB40851	Punta elicoidale cilindrica HSS 1,75 mm fresata	1,75	10 pz	10 scatole
NB40857	Punta elicoidale cilindrica HSS 2 mm fresata	2	10 pz	10 scatole
NB40863	Punta elicoidale cilindrica HSS 2,25 mm fresata	2,25	10 pz	10 scatole
NB40869	Punta elicoidale cilindrica HSS 2,5 mm fresata	2,5	10 pz	10 scatole
NB40875	Punta elicoidale cilindrica HSS 2,75 mm fresata	2,75	10 pz	10 scatole
NB40881	Punta elicoidale cilindrica HSS 3 mm fresata	3	10 pz	10 scatole
NB40887	Punta elicoidale cilindrica HSS 3,25 mm fresata	3,25	10 pz	10 scatole
NB40893	Punta elicoidale cilindrica HSS 3,5 mm fresata	3,5	10 pz	10 scatole
NB40899	Punta elicoidale cilindrica HSS 3,75 mm fresata	3,75	10 pz	10 scatole
NB40905	Punta elicoidale cilindrica HSS 4 mm fresata	4	10 pz	10 scatole
NB40911	Punta elicoidale cilindrica HSS 4,25 mm fresata	4,25	10 pz	10 scatole
NB40917	Punta elicoidale cilindrica HSS 4,5 mm fresata	4,5	10 pz	10 scatole
NB40923	Punta elicoidale cilindrica HSS 4,75 mm fresata	4,75	10 pz	10 scatole
NB40929	Punta elicoidale cilindrica HSS 5 mm fresata	5	10 pz	10 scatole
NB40935	Punta elicoidale cilindrica HSS 5,25 mm fresata	5,25	10 pz	10 scatole
NB40941	Punta elicoidale cilindrica HSS 5,5 mm fresata	5,5	10 pz	10 scatole
NB40943	Punta elicoidale cilindrica HSS 5,75 mm fresata	5,75	10 pz	10 scatole
NB40949	Punta elicoidale cilindrica HSS 6 mm fresata	6	10 pz	10 scatole
NB40955	Punta elicoidale cilindrica HSS 6,25 mm fresata	6,25	10 pz	10 scatole
NB40961	Punta elicoidale cilindrica HSS 6,5 mm fresata	6,5	10 pz	10 scatole
NB40971	Punta elicoidale cilindrica HSS 7 mm fresata	7	10 pz	10 scatole
NB40981	Punta elicoidale cilindrica HSS 7,5 mm fresata	7,5	10 pz	10 scatole
NB40989	Punta elicoidale cilindrica HSS 8 mm fresata	8	10 pz	10 scatole
NB40995	Punta elicoidale cilindrica HSS 8,5 mm fresata	8,5	5 pz	5 scatole
NB41001	Punta elicoidale cilindrica HSS 9 mm fresata	9	5 pz	5 scatole
NB41009	Punta elicoidale cilindrica HSS 9,5 mm fresata	9,5	5 pz	5 scatole
NB41013	Punta elicoidale cilindrica HSS 10 mm fresata	10	5 pz	5 scatole
NB41017	Punta elicoidale cilindrica HSS 10,5 mm fresata	10,5	5 pz	5 scatole
NB41021	Punta elicoidale cilindrica HSS 11 mm fresata	11	5 pz	5 scatole
NB41025	Punta elicoidale cilindrica HSS 11,5 mm fresata	11,5	5 pz	5 scatole
NB41029	Punta elicoidale cilindrica HSS 12 mm fresata	12	5 pz	5 scatole
NB41037	Punta elicoidale cilindrica HSS 13 mm fresata	13	5 pz	5 scatole

Punte per metalli

MATERIALI DI SUPPORTO Indicata per foratura di lega acciaio - ghisa - acciaio inox.

HSS COBALTO 5% - Punta elicoidale cilindrica, hss cobalto 5%, professionale, DIN 338

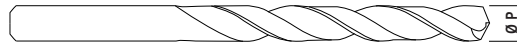

indicata per Acciaio legato, Acciaio inossidabile, Ghisa



Codice	Descrizione	Ø P mm	Scatola singola	Imballo complessivo
NB40170	Punta elicoidale al cobalto 5% HSS 1 mm	1	10 pz	5 scatole
NB40176	Punta elicoidale al cobalto 5% HSS 1,25 mm	1,25	10 pz	5 scatole
NB40180	Punta elicoidale al cobalto 5% HSS 1,5 mm	1,5	10 pz	5 scatole
NB40184	Punta elicoidale al cobalto 5% HSS 1,75 mm	1,75	10 pz	5 scatole
NB40188	Punta elicoidale al cobalto 5% HSS 2 mm	2	10 pz	5 scatole
NB40194	Punta elicoidale al cobalto 5% HSS 2,25 mm	2,25	10 pz	5 scatole
NB40200	Punta elicoidale al cobalto 5% HSS 2,5 mm	2,25	10 pz	5 scatole
NB40204	Punta elicoidale al cobalto 5% HSS 2,75 mm	2,75	10 pz	5 scatole
NB40208	Punta elicoidale al cobalto 5% HSS 3 mm	3	10 pz	5 scatole
NB40214	Punta elicoidale al cobalto 5% HSS 3,25 mm	3,25	10 pz	5 scatole
NB40220	Punta elicoidale al cobalto 5% HSS 3,5 mm	3,5	10 pz	5 scatole
NB40226	Punta elicoidale al cobalto 5% HSS 3,75 mm	3,75	10 pz	5 scatole
NB40232	Punta elicoidale al cobalto 5% HSS 4 mm	4	10 pz	5 scatole
NB40238	Punta elicoidale al cobalto 5% HSS 4,25 mm	4,25	10 pz	5 scatole
NB40244	Punta elicoidale al cobalto 5% HSS 4,5 mm	4,5	10 pz	5 scatole
NB40250	Punta elicoidale al cobalto 5% HSS 4,75 mm	4,75	10 pz	5 scatole
NB40256	Punta elicoidale al cobalto 5% HSS 5 mm	5	10 pz	5 scatole
NB40260	Punta elicoidale al cobalto 5% HSS 5,5 mm	5,5	10 pz	5 scatole
NB40268	Punta elicoidale al cobalto 5% HSS 6 mm	6	10 pz	5 scatole
NB40276	Punta elicoidale al cobalto 5% HSS 6,5 mm	6,5	10 pz	5 scatole
NB40288	Punta elicoidale al cobalto 5% HSS 7,5 mm	7,5	10 pz	5 scatole
NB40296	Punta elicoidale al cobalto 5% HSS 8 mm	8	10 pz	5 scatole
NB40300	Punta elicoidale al cobalto 5% HSS 8,5 mm	8,5	5 pz	5 scatole
NB40304	Punta elicoidale al cobalto 5% HSS 9 mm	9	5 pz	5 scatole
NB40308	Punta elicoidale al cobalto 5% HSS 9,5 mm	9,5	5 pz	5 scatole
NB40314	Punta elicoidale al cobalto 5% HSS 10 mm	10	10 pz	5 scatole
NB40320	Punta elicoidale al cobalto 5% HSS 10,5 mm	10,5	5 pz	5 scatole
NB40324	Punta elicoidale al cobalto 5% HSS 11 mm	11	10 pz	5 scatole
NB40328	Punta elicoidale al cobalto 5% HSS 11,5 mm	11,5	5 pz	5 scatole
NB40332	Punta elicoidale al cobalto 5% HSS 12 mm	12	10 pz	5 scatole
NB40336	Punta elicoidale al cobalto 5% HSS 12,5 mm	12,5	5 pz	5 scatole
NB40340	Punta elicoidale al cobalto 5% HSS 13 mm	13	10 pz	5 scatole

Punte per metalli

HSS COBALTO 8% - Punta elicoidale cilindrica, hss Cobalto 8%, professionale, DIN 338

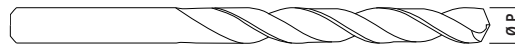

indicata per Acciaio legato, Acciaio inossidabile, Ghisa

Codice	Descrizione	Ø P mm	Scatola singola	Imballo complessivo
NB41140	Punta elicoidale al Cobalto 8% HSS 1 mm	1	10 pz	5 scatole
NB41142	Punta elicoidale al Cobalto 8% HSS 1,25 mm	1,25	10 pz	5 scatole
NB41144	Punta elicoidale al Cobalto 8% HSS 1,5 mm	1,5	10 pz	5 scatole
NB41146	Punta elicoidale al Cobalto 8% HSS 1,75 mm	1,75	10 pz	5 scatole
NB41148	Punta elicoidale al Cobalto 8% HSS 2 mm	2	10 pz	5 scatole
NB41152	Punta elicoidale al Cobalto 8% HSS 2,25 mm	2,25	10 pz	5 scatole
NB41156	Punta elicoidale al Cobalto 8% HSS 2,5 mm	2,5	10 pz	5 scatole
NB41160	Punta elicoidale al Cobalto 8% HSS 2,75 mm	2,75	10 pz	5 scatole
NB41164	Punta elicoidale al Cobalto 8% HSS 3 mm	3	10 pz	5 scatole
NB41170	Punta elicoidale al Cobalto 8% HSS 3,25 mm	3,25	10 pz	5 scatole
NB41174	Punta elicoidale al Cobalto 8% HSS 3,5 mm	3,5	10 pz	5 scatole
NB41178	Punta elicoidale al Cobalto 8% HSS 3,75 mm	3,75	10 pz	5 scatole
NB41180	Punta elicoidale al Cobalto 8% HSS 4 mm	4	10 pz	5 scatole
NB41186	Punta elicoidale al Cobalto 8% HSS 4,25 mm	4,25	10 pz	5 scatole
NB41190	Punta elicoidale al Cobalto 8% HSS 4,5 mm	4,5	10 pz	5 scatole
NB41194	Punta elicoidale al Cobalto 8% HSS 4,75 mm	4,75	10 pz	5 scatole
NB41198	Punta elicoidale al Cobalto 8% HSS 5 mm	5	10 pz	5 scatole
NB41204	Punta elicoidale al Cobalto 8% HSS 5,5 mm	5,5	10 pz	5 scatole
NB41212	Punta elicoidale al Cobalto 8% HSS 6 mm	6	10 pz	5 scatole
NB41218	Punta elicoidale al Cobalto 8% HSS 6,5 mm	6,5	10 pz	5 scatole
NB41224	Punta elicoidale al Cobalto 8% HSS 7 mm	7	10 pz	5 scatole
NB41228	Punta elicoidale al Cobalto 8% HSS 7,5 mm	7,5	10 pz	5 scatole
NB41232	Punta elicoidale al Cobalto 8% HSS 8 mm	8	10 pz	5 scatole
NB41238	Punta elicoidale al Cobalto 8% HSS 8,5 mm	8,5	10 pz	5 scatole
NB41244	Punta elicoidale al Cobalto 8% HSS 9 mm	9	10 pz	5 scatole
NB41248	Punta elicoidale al Cobalto 8% HSS 9,5 mm	9,5	10 pz	5 scatole
NB41252	Punta elicoidale al Cobalto 8% HSS 10 mm	10	10 pz	5 scatole
NB41258	Punta elicoidale al Cobalto 8% HSS 10,5 mm	10,5	5 pz	5 scatole
NB41262	Punta elicoidale al Cobalto 8% HSS 11 mm	11	5 pz	5 scatole
NB41266	Punta elicoidale al Cobalto 8% HSS 11,5 mm	11,5	5 pz	5 scatole
NB41270	Punta elicoidale al Cobalto 8% HSS 12 mm	12	5 pz	5 scatole
NB41274	Punta elicoidale al Cobalto 8% HSS 12,5 mm	12,5	5 pz	5 scatole
NB41276	Punta elicoidale al Cobalto 8% HSS 13 mm	13	5 pz	5 scatole

Punte per muro

Punte in acciaio Cr40 di elevata qualità.

Disponibili con attacco cilindrico, SDS PLUS e SDS MAX, fresate, interamente rettificate, con placchette ad alta resistenza saldata o monoblocco.

La particolare geometria delle placchette le rende autcentranti e aumenta la rimozione dei detriti in fase di foratura.

MATERIALI DI SUPPORTO Edilizia

HM SU - Punte professionali per forare a forte percussione per muro lunghezza standard

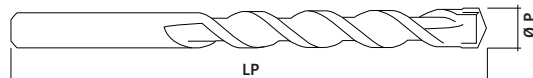

indicata per Pietra naturale, mattoni, calcestruzzo, granito

Codice	Descrizione	Ø P mm	LP mm	Scatola singola	Imballo complessivo
NB39707	Punte professionali perforare a forte percussione HM-SU 3x60 mm	3	60	10 pz	5 scatole
NB39710	Punte professionali perforare a forte percussione HM-SU 4x75 mm	4	75	10 pz	5 scatole
NB39727	Punte professionali perforare a forte percussione HM-SU 5x85 mm	5	85	10 pz	5 scatole
NB39741	Punte professionali perforare a forte percussione HM-SU 6x100 mm	6	100	10 pz	5 scatole
NB39765	Punte professionali perforare a forte percussione HM-SU 7x100 mm	7	100	10 pz	5 scatole
NB39772	Punte professionali perforare a forte percussione HM-SU 8x120 mm	8	120	10 pz	15 scatole
NB39789	Punte professionali perforare a forte percussione HM-SU 9x120 mm	9	120	10 pz	5 scatole
NB39796	Punte professionali perforare a forte percussione HM-SU 10x120 mm	10	120	10 pz	5 scatole
NB39819	Punte professionali perforare a forte percussione HM-SU 12x150 mm	12	150	10 pz	5 scatole
NB39833	Punte professionali perforare a forte percussione HM-SU 14x150 mm	14	150	5 pz	5 scatole
NB39840	Punte professionali perforare a forte percussione HM-SU 15x150 mm	15	150	5 pz	5 scatole
NB39857	Punte professionali perforare a forte percussione HM-SU 16x150 mm	16	150	5 pz	5 scatole
NB39859	Punte professionali perforare a forte percussione HM-SU 18x160 mm	18	160	5 pz	5 scatole
NB39861	Punte professionali perforare a forte percussione HM-SU 20x160 mm	20	160	5 pz	5 scatole
NB39863	Punte professionali perforare a forte percussione HM-SU 22x160 mm	22	160	5 pz	5 scatole

Altre misure e lunghezze disponibili a richiesta

SDS-PLUS 4 - Punte per tassellatori a 4 taglienti roto-percussione

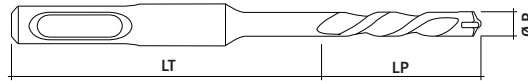

indicata per Pietra naturale, mattoni, calcestruzzo, cemento armato

Codice	Descrizione	Ø P mm	LT mm	LP mm	Scatola singola	Imballo complessivo
NB41300	Punta per tassellatori SDS-PLUS 5x50x110 mm	5	50	110	1 pz	10 scatole
NB41303	Punta per tassellatori SDS-PLUS 5x100x160 mm	5	100	160	1 pz	10 scatole
NB41312	Punta per tassellatori SDS-PLUS 6x50x110 mm	6	50	110	1 pz	10 scatole
NB41315	Punta per tassellatori SDS-PLUS 6x100x160 mm	6	100	160	1 pz	10 scatole
NB41318	Punta per tassellatori SDS-PLUS 4X4 6X150X210 mm	6	150	210	1 pz	10 scatole
NB41323	Punta per tassellatori SDS-PLUS 4X4 6X250X310 mm	6	250	310	1 pz	10 scatole
NB41339	Punta per tassellatori SDS-PLUS 4X4 7X50X110 mm	7	50	110	1 pz	10 scatole
NB41341	Punta per tassellatori SDS-PLUS 4X4 7X100X160 mm	7	100	160	1 pz	10 scatole
NB41345	Punta per tassellatori SDS-PLUS 4X4 8X50X110 mm	8	50	110	1 pz	10 scatole
NB41348	Punta per tassellatori SDS-PLUS 4X4 8X100X160 mm	8	100	160	1 pz	10 scatole
NB41351	Punta per tassellatori SDS-PLUS 4X4 8X150X210 mm	8	150	210	1 pz	10 scatole
NB41354	Punta per tassellatori SDS-PLUS 4X4 8X200X260 mm	8	200	260	1 pz	10 scatole
NB41363	Punta per tassellatori SDS-PLUS 4X4 10X50X110 mm	10	50	110	1 pz	10 scatole
NB41366	Punta per tassellatori SDS-PLUS 4X4 10X100X160 mm	10	100	160	1 pz	10 scatole
NB41369	Punta per tassellatori SDS-PLUS 4X4 10X150X210 mm	10	150	210	1 pz	10 scatole
NB41372	Punta per tassellatori SDS-PLUS 4X4 10X200X260 mm	10	200	260	1 pz	10 scatole
NB41378	Punta per tassellatori SDS-PLUS 4X4 10X400X450 mm	10	400	450	1 pz	10 scatole
NB41387	Punta per tassellatori SDS-PLUS 4X4 12X100X160 mm	12	100	160	1 pz	10 scatole
NB41390	Punta per tassellatori SDS-PLUS 4X4 12X150X210 mm	12	150	210	1 pz	10 scatole
NB41393	Punta per tassellatori SDS-PLUS 4X4 12X200X260 mm	12	200	260	1 pz	10 scatole
NB41399	Punta per tassellatori SDS-PLUS 4X4 12X400X450 mm	12	400	450	1 pz	10 scatole
NB41408	Punta per tassellatori SDS-PLUS 4X4 14X100X160 mm	14	100	160	1 pz	10 scatole
NB41411	Punta per tassellatori SDS-PLUS 4X4 14X150X210 mm	14	150	210	1 pz	10 scatole
NB41414	Punta per tassellatori SDS-PLUS 4X4 14X200X260 mm	14	200	260	1 pz	10 scatole
NB41420	Punta per tassellatori SDS-PLUS 4X4 14X400X450 mm	14	400	450	1 pz	10 scatole
NB41441	Punta per tassellatorio SDS-PLUS 4X4 16X100X160 mm	16	100	160	1 pz	10 scatole
NB41444	Punta per tassellatori SDS-PLUS 4X4 16X150X210 mm	16	150	210	1 pz	10 scatole
NB41447	Punta per tassellatori SDS-PLUS 4X4 16X200X260 mm	16	200	260	1 pz	10 scatole
NB41453	Punta per tassellatori SDS-PLUS 4X4 16X400X450 mm	16	400	450	1 pz	10 scatole
NB41461	Punta per tassellatori SDS-PLUS 4X4 18X150X210 mm	18	150	210	1 pz	10 scatole
NB41462	Punta per tassellatori SDS-PLUS 4X4 18X200X260 mm	18	200	260	1 pz	10 scatole
NB41463	Punta per tassellatori SDS-PLUS 4X4 18X250X310 mm	18	250	310	1 pz	10 scatole
NB41465	Punta per tassellatori SDS-PLUS 4X4 18X400X450 mm	18	400	450	1 pz	10 scatole
NB41467	Punta per tassellatori SDS-PLUS 4X4 20X150X210 mm	20	150	210	1 pz	10 scatole
NB41468	Punta per tassellatori SDS-PLUS 4X4 20X200X260 mm	20	200	260	1 pz	10 scatole
NB41469	Punta per tassellatori SDS-PLUS 4X4 20X250X310 mm	20	250	310	1 pz	10 scatole
NB41471	Punta per tassellatori SDS-PLUS 4X4 20X400X450 mm	20	400	450	1 pz	10 scatole
NB41474	Punta per tassellatori SDS-PLUS 4X4 22X200X260 mm	22	200	260	1 pz	10 scatole
NB41475	Punta per tassellatori SDS-PLUS 4X4 22X250X310 mm	22	250	310	1 pz	10 scatole
NB41477	Punta per tassellatori SDS-PLUS 4X4 22X400X450 mm	22	400	450	1 pz	10 scatole
NB41480	Punta per tassellatori SDS-PLUS 4X4 24X200X260 mm	24	200	260	1 pz	10 scatole
NB41483	Punta per tassellatori SDS-PLUS 4X4 24X400X450 mm	24	400	450	1 pz	10 scatole
NB41486	Punta per tassellatori SDS-PLUS 4X4 25X200X260 mm	25	200	260	1 pz	10 scatole
NB41489	Punta per tassellatori SDS-PLUS 4X4 25X400X450 mm	25	400	450	1 pz	10 scatole

Altre misure e lunghezze disponibili a richiesta

Punte per muro

SDS-MAX 3 - Punte per martelli perforatori a 6 taglienti

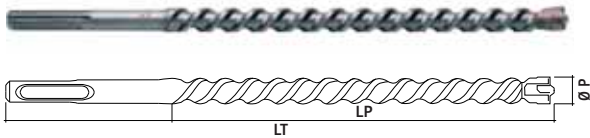

indicata per Pietra naturale, mattoni, calcestruzzo, granito, cemento armato



Codice	Descrizione	Ø P mm	LT mm	LP mm	Scatola singola	Imballo complessivo
NB41500	Punta per trapani a martello 3 taglienti SDS-MAX 12x200x340 mm	12	200	340	1 pz	5 scatole
NB41503	Punta per trapani a martello 3 taglienti SDS-MAX 12x400x540 mm	12	400	540	1 pz	5 scatole
NB41506	Punta per trapani a martello 3 taglienti SDS-MAX 12x600x690 mm	12	600	690	1 pz	5 scatole
NB41515	Punta per trapani a martello 3 taglienti SDS-MAX 14x200x340 mm	14	200	340	1 pz	5 scatole
NB41527	Punta per trapani a martello 3 taglienti SDS-MAX 15x200x340 mm	15	200	340	1 pz	5 scatole
NB41533	Punta per trapani a martello 3 taglienti SDS-MAX 16x200x340 mm	16	200	340	1 pz	5 scatole
NB41554	Punta per trapani a martello 3 taglienti SDS-MAX 18x200x340 mm	18	200	340	1 pz	5 scatole
NB41557	Punta per trapani a martello 3 taglienti SDS-MAX 18x400x540 mm	18	400	540	1 pz	5 scatole
NB41563	Punta per trapani a martello 3 taglienti SDS-MAX 18x800x940 mm	18	800	940	1 pz	5 scatole
NB41575	Punta per trapani a martello 3 taglienti SDS-MAX 20x200x320 mm	20	200	320	1 pz	5 scatole
NB41578	Punta per trapani a martello 3 taglienti SDS-MAX 20x400x520 mm	20	400	520	1 pz	5 scatole
NB41584	Punta per trapani a martello 3 taglienti SDS-MAX 20x800x920 mm	20	800	920	1 pz	5 scatole
NB41590	Punta per trapani a martello 3 taglienti SDS-MAX 22x200x320 mm	22	200	320	1 pz	5 scatole
NB41599	Punta per trapani a martello 3 taglienti SDS-MAX 22x800x920 mm	22	800	920	1 pz	5 scatole
NB41605	Punta per trapani a martello 3 taglienti SDS-MAX 24x200x320 mm	24	200	320	1 pz	5 scatole
NB41608	Punta per trapani a martello 3 taglienti SDS-MAX 24x400x520 mm	24	400	520	1 pz	5 scatole
NB41611	Punta per trapani a martello 3 taglienti SDS-MAX 25x200x320 mm	25	200	320	1 pz	5 scatole
NB41614	Punta per trapani a martello 3 taglienti SDS-MAX 25x400x520 mm	25	400	520	1 pz	5 scatole
NB41620	Punta per trapani a martello 3 taglienti SDS-MAX 25x800x920 mm	25	800	920	1 pz	5 scatole
NB41623	Punta per trapani a martello 3 taglienti SDS-MAX 25x1200x1320 mm	25	1200	1320	1 pz	5 scatole
NB41632	Punta per trapani a martello 3 taglienti SDS-MAX 28x200x320 mm	28	200	320	1 pz	5 scatole
NB41635	Punta per trapani a martello 3 taglienti SDS-MAX 28x400x520 mm	28	400	520	1 pz	5 scatole
NB41638	Punta per trapani a martello 3 taglienti SDS-MAX 28x600x720 mm	28	600	720	1 pz	5 scatole
NB41647	Punta per trapani a martello 3 taglienti SDS-MAX 30x200x320 mm	30	200	320	1 pz	5 scatole
NB41650	Punta per trapani a martello 3 taglienti SDS-MAX 30x400x520 mm	30	400	520	1 pz	5 scatole
NB41653	Punta per trapani a martello 3 taglienti SDS-MAX 32x200x320 mm	32	200	320	1 pz	5 scatole
NB41656	Punta per trapani a martello 3 taglienti SDS-MAX 32x400x520 mm	32	400	520	1 pz	5 scatole
NB41662	Punta per trapani a martello 3 taglienti SDS-MAX 32x800x920 mm	32	800	920	1 pz	5 scatole
NB41665	Punta per trapani a martello 3 taglienti DS-MAX 32x1200x1320 mm	32	1200	1320	1 pz	5 scatole
NB41668	Punta per trapani a martello 3 taglienti SDS-MAX 35x200x320 mm	35	200	320	1 pz	5 scatole
NB41674	Punta per trapani a martello 3 taglienti SDS-MAX 35x600x720 mm	35	600	720	1 pz	5 scatole
NB41692	Punta per trapani a martello 3 taglienti SDS-MAX 38x200x320 mm	38	200	320	1 pz	5 scatole
NB41695	Punta per trapani a martello 3 taglienti SDS-MAX 38x400x520 mm	38	400	520	1 pz	5 scatole
NB41701	Punta per trapani a martello 3 taglienti SDS-MAX 40x200x320 mm	40	200	320	1 pz	5 scatole
NB41710	Punta per trapani a martello 3 taglienti SDS-MAX 40x800x920 mm	40	800	920	1 pz	5 scatole
NB41713	Punta per trapani a martello 3 taglienti SDS-MAX 40x1200x260 mm	40	1200	260	1 pz	5 scatole
NB41716	Punta per trapani a martello 3 taglienti SDS-MAX 45x400x520 mm	45	400	520	1 pz	5 scatole
NB41719	Punta per trapani a martello 3 taglienti SDS-MAX 50x400x520 mm	50	400	520	1 pz	5 scatole

Accessori

SDS PLUS - Adattatore SDS PLUS1/2x20 UNF per mandrini



Codice	Descrizione	Ø inch	L mm	Scatola singola	Imballo complessivo
NB43930	Adattatore SDS 1/2x20 mm UNF per mandrini	1/2	20	1 pz	5 scatole

Accessori e scalpelli

ACCESSORI E SCALPELLI - con corpo forgiato ineramente rettificato



Scalpellini per trapano a martello con innesto SDS-PLUS



Codice	Descrizione	LT mm	L mm	Scatola singola
NB43330	DS-PLUS scalpello a punta 250 mm	-	250	1 pz
NB43333	SDS-PLUS scalpello a taglio 250 mm	-	250	1 pz
NB43336	SDS-PLUS scalpello largo 40x250 mm	40	250	1 pz
NB43339	SDS-PLUS scalpello a canale 22x250 mm	22	250	1 pz
NB43341	SDS-PLUS scalpello curvo 40x250 mm	40	250	1 pz

Scalpellini per trapano a martello con innesto SDS-MAX



Codice	Descrizione	LT mm	L mm	Scatola singola
NB43300	SDS-MAX scalpello a punta 280 mm	-	280	1 pz
NB43303	SDS-MAX scalpello a punta 400 mm	-	400	1 pz
NB43306	SDS-MAX scalpello a punta 600 mm	-	600	1 pz
NB43309	SDS-MAX scalpello piatto 25x280 mm	25	280	1 pz
NB43312	SDS-MAX scalpello piatto 25x400 mm	25	400	1 pz
NB43315	SDS-MAX scalpello piatto 25x600 mm	25	600	1 pz
NB43318	SDS-MAX scalpello largo 50x400 mm	50	400	1 pz
NB43324	SDS-MAX scalpello largo 75x300 mm	75	300	1 pz
NB43321	SDS-MAX scalpello sgorbia 26x300 mm	26	300	1 pz

Fresa a corona

FRESA A CORONA - Per martelli leggeri Profondità utile 50 mm con attacco M 16**indicata per** Pietra naturale, mattoni, calcestruzzo, granito, cemento armato

Codice	Descrizione	Ø mm	Attacco M	Scatola singola
NB43800	Fresa a corona Ø 25 attacco M 16	25	16	1 pz
NB43803	Fresa a corona Ø 30 attacco M 16	30	16	1 pz
NB43806	Fresa a corona Ø 35 attacco M 16	35	16	1 pz
NB43809	Fresa a corona Ø 40 attacco M 16	40	16	1 pz
NB43812	Fresa a corona Ø 50 attacco M 16	50	16	1 pz
NB43815	Fresa a corona Ø 66 attacco M 16	66	16	1 pz
NB43818	Fresa a corona Ø 70 attacco M 16	70	16	1 pz
NB43821	Fresa a corona Ø 72 attacco M 16	72	16	1 pz
NB43824	Fresa a corona Ø 80 attacco M 16	80	16	1 pz
NB43827	Fresa a corona Ø 90 attacco M 16	90	16	1 pz
NB43829	Fresa a corona Ø 100 attacco M 16	100	16	1 pz
NB43833	Fresa a corona Ø 110 attacco M 16	110	16	1 pz
NB43836	Fresa a corona Ø 125 attacco M 16	125	16	1 pz

**Prolunghe attacco esagonale - M/16**

Codice	Descrizione	L mm	Attacco M	Scatola singola
NB43850	Prolunga attacco esagonale M 16 100 mm	100	16	1 pz
NB43853	Prolunga attacco esagonale M16 200 mm	200	16	1 pz
NB43856	Prolunga attacco esagonale M16 350 mm	350	16	1 pz
NB43859	Prolunga attacco esagonale M16 450 mm	450	16	1 pz

**Prolunghe attacco SDS-PLUS - M/16**

Codice	Descrizione	L mm	Attacco M	Scatola singola
NB43862	Prolunga attacco SDS-PLUS M16 100 mm	100	16	1 pz
NB43865	Prolunga attacco SDS-PLUS M16 200 mm	200	16	1 pz
NB43868	Prolunga attacco SDS-PLUS M16 350 mm	350	16	1 pz
NB43871	Prolunga attacco SDS-PLUS M16 450 mm	450	16	1 pz

Fresa a corona

FRESA A CORONA - Per martelli leggeri Profondità utile 50 mm con attacco M 22



Codice	Descrizione	Ø mm	Attacco M mm	Scatola singola
NB43900	Fresa a corona Ø 50 attacco M 22	50	22	1 pz
NB43903	Fresa a corona Ø 66 attacco M 22	66	22	1 pz
NB43906	Fresa a corona Ø 80 attacco M 22	80	22	1 pz
NB43912	Fresa a corona Ø 90 attacco M 22	90	22	1 pz
NB43915	Fresa a corona Ø 100 attacco M 22	100	22	1 pz
NB43918	Fresa a corona Ø 112 attacco M 22	112	22	1 pz
NB43921	Fresa a corona Ø 125 attacco M 22	125	22	1 pz



Prolunghe attacco SDS-PLUS - M/22



Codice	Descrizione	L mm	Attacco M mm	Scatola singola
NB43950	Prolunga SDS-PLUS M 22 100 mm	100	22	1 pz
NB43953	Prolunga SDS-PLUS M 22 200 mm	200	22	1 pz
NB43956	Prolunga SDS-PLUS M 22 350 mm	350	22	1 pz
NB43959	Prolunga SDS-PLUS M 22 450 mm	450	22	1 pz



Punta centratore per prolunga



Codice	Descrizione	Ø mm	L mm	Scatola singola
NB43880	Punta centratore per prolunga 8x120 mm	8	120	1 pz

Fresa a corona

FRESA A CORONA - Fresa a corona per attacco SDS-MAX per applicazioni a roto-percussione



indicata per Pietra naturale, mattoni, calcestruzzo, granito, cemento armato



Codice	Descrizione	Ø mm	Attacco mm	Scatola singola
NB43600	Fresa a corona Ø 40 attacco SDS-MAX	40	SDS-MAX	1 pz
NB43603	Fresa a corona Ø 50 attacco SDS-MAX	50	SDS-MAX	1 pz
NB43606	Fresa a corona Ø 60 attacco SDS-MAX	60	SDS-MAX	1 pz
NB43609	Fresa a corona Ø 66 attacco SDS-MAX	40	SDS-MAX	1 pz
NB43612	Fresa a corona Ø 80 attacco SDS-MAX	50	SDS-MAX	1 pz
NB43615	Fresa a corona Ø 90 attacco SDS-MAX	66	SDS-MAX	1 pz
NB43617	Fresa a corona Ø 100 attacco SDS-MAX	70	SDS-MAX	1 pz
NB43621	Fresa a corona Ø 112 attacco SDS-MAX	72	SDS-MAX	1 pz
NB43624	Fresa a corona Ø 125 attacco SDS-MAX	80	SDS-MAX	1 pz
NB43627	Fresa a corona Ø 130 attacco SDS-MAX	90	SDS-MAX	1 pz
NB43630	Fresa a corona Ø 150 attacco SDS-MAX	100	SDS-MAX	1 pz



Prolunghe attacco SDS-MAX



Codice	Descrizione	L mm	Attacco mm	Scatola singola
NB43750	Prolunga attacco SDS-MAX 250 mm	250	SDS-MAX	1 pz
NB43753	Prolunga attacco SDS-MAX 450 mm	450	SDS-MAX	1 pz
NB43756	Prolunga attacco SDS-MAX 600 mm	600	SDS-MAX	1 pz



Punta centratore conica per prolunga con attacco SDS-MAX



Codice	Descrizione	Ø mm	L mm	Scatola singola
NB43790	Punta centratore conica prolunga 12x135 mm	12	135	1 pz

Punte per legno

PEL - Punte elicoidali per legno - acciaio HSS - doppia elica

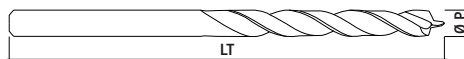

indicata per legno laminato, trave, legno compensato, legno duro, legno naturale dolce, cartongesso.



Codice	Descrizione	Ø mm	L mm	Scatola singola
NB39200	Punta elicoidali PEL 3x60 mm	3	60	1 pz
NB39202	Punta elicoidali PEL 4x75 mm	4	75	1 pz
NB39204	Punta elicoidali PEL 5x85 mm	5	85	1 pz
NB39206	Punta elicoidali PEL 6x90 mm	6	90	1 pz
NB39208	Punta elicoidali PEL 7x105 mm	7	105	1 pz
NB39210	Punta elicoidali PEL 8x110 mm	8	110	1 pz
NB39212	Punta elicoidali PEL 9x115 mm	9	115	1 pz
NB39214	Punta elicoidali PEL 10x120 mm	10	120	1 pz
NB39216	Punta elicoidali PEL 11x130 mm	11	130	1 pz
NB39218	Punta elicoidali PEL 12x140 mm	12	140	1 pz
NB39220	Punta elicoidali PEL 13x150 mm	13	150	1 pz
NB39222	Punta elicoidali PEL 14x150 mm	14	150	1 pz
NB39224	Punta elicoidali PEL 15x160 mm	15	160	1 pz
NB39226	Punta elicoidali PEL 16x160 mm	16	160	1 pz
NB39228	Punta elicoidali PEL 18x180 mm	18	180	1 pz
NB39230	Punta elicoidali PEL 20x230 mm	20	230	1 pz

Inserti BIT per viti

BIT - Inserti per viti con attacco SDS-MAX



BIT-PH



Codice	Descrizione	L mm	Impronta	Scatola singola
NB40610	Inserti per viti con attacco BIT-PH 0	25	Phillips	10 pz
NB40612	Inserti per viti con attacco BIT-PH 1	25	Phillips	10 pz
NB40614	Inserti per viti con attacco BIT-PH 2	25	Phillips	10 pz
NB40616	Inserti per viti con attacco BIT-PH 3	25	Phillips	10 pz
NB40618	Inserti per viti con attacco BIT-PH 4	25	Phillips	10 pz
NB40620	Inserti per viti con attacco BIT-PH 1	25	Phillips	25 pz
NB40622	Inserti per viti con attacco BIT-PH 2	25	Phillips	25 pz
NB40624	Inserti per viti con attacco BIT-PH 3	25	Phillips	25 pz
NB40630	Inserti per viti con attacco BIT-PH 1	25	Phillips	50 pz
NB40632	Inserti per viti con attacco BIT-PH 2	25	Phillips	50 pz
NB40634	Inserti per viti con attacco BIT-PH 3	25	Phillips	50 pz

Inserti BIT per viti



BIT-PZD



Codice	Descrizione	L mm	Impronta	Scatola singola
NB40640	Inserti per viti con attacco BIT-PZD 0	25	Pozidriv	10 pz
NB40642	Inserti per viti con attacco BIT-PZD 1	25	Pozidriv	10 pz
NB40644	Inserti per viti con attacco BIT-PZD 2	25	Pozidriv	10 pz
NB40646	Inserti per viti con attacco BIT-PZD 3	25	Pozidriv	10 pz
NB40648	Inserti per viti con attacco BIT-PZD 4	25	Pozidriv	10 pz
NB40650	Inserti per viti con attacco BIT-PZD 1	25	Pozidriv	25 pz
NB40652	Inserti per viti con attacco BIT-PZD 2	25	Pozidriv	25 pz
NB40654	Inserti per viti con attacco BIT-PZD 3	25	Pozidriv	25 pz
NB40660	Inserti per viti con attacco BIT-PZD 1	25	Pozidriv	50 pz
NB40662	Inserti per viti con attacco BIT-PZD 2	25	Pozidriv	50 pz
NB40664	Inserti per viti con attacco BIT-PZD 3	25	Pozidriv	50 pz



BIT-TX



Codice	Descrizione	L mm	Impronta	Scatola singola
NB40670	Inserti per viti con attacco BIT-TX 6	25	Torx	10 pz
NB40672	Inserti per viti con attacco BIT-TX 7	25	Torx	10 pz
NB40674	Inserti per viti con attacco BIT-TX 8	25	Torx	10 pz
NB40676	Inserti per viti con attacco BIT-TX 9	25	Torx	10 pz
NB40678	Inserti per viti con attacco BIT-TX 10	25	Torx	10 pz
NB40680	Inserti per viti con attacco BIT-TX 15	25	Torx	10 pz
NB40682	Inserti per viti con attacco BIT-TX 20	25	Torx	10 pz
NB40684	Inserti per viti con attacco BIT-TX 25	25	Torx	10 pz
NB40686	Inserti per viti con attacco BIT-TX 27	25	Torx	10 pz
NB40688	Inserti per viti con attacco BIT-TX 30	25	Torx	10 pz
NB40690	Inserti per viti con attacco BIT-TX 40	25	Torx	10 pz



BIT-TA



Codice	Descrizione	L mm	Impronta	Scatola singola
NB49700	Inserti per viti con attacco BIT-TA 3,0x0,5 mm	25	Taglio	10 pz
NB49702	Inserti per viti con attacco BIT-TA 4,5x0,6 mm	25	Taglio	10 pz
NB49704	Inserti per viti con attacco BIT-TA 5,5x0,8 mm	25	Taglio	10 pz
NB49706	Inserti per viti con attacco BIT-TA 6,5x1,2 mm	25	Taglio	10 pz
NB49710	Inserti per viti con attacco BIT-TA 3,0x0,5 mm	25	Taglio	25 pz
NB49712	Inserti per viti con attacco BIT-TA 4,5x0,6 mm	25	Taglio	25 pz
NB49714	Inserti per viti con attacco BIT-TA 5,5x0,8 mm	25	Taglio	25 pz
NB49716	Inserti per viti con attacco BIT-TA 6,5x1,2 mm	25	Taglio	25 pz

Accessori

PORTAINSERTI MAGNETICO - Con attacco esagonale 1/4



Codice	Descrizione	L mm	Scatola singola
NB40602	Portainseriti magnetico	60	5 pz

PORTAINSERTI QUICK - Rapido con attacco esagonale 1/4



Codice	Descrizione	L mm	Scatola singola
NB40604	Portainseriti QUICK	60	5 pz

Codice	Pagina	Codice	Pagina	Codice	Pagina	Codice	Pagina	Codice	Pagina	Codice	Pagina	Codice	Pagina
NB1007	15	NB11600	113	NB12456	104	NB13512	110	NB14460	116	NB16056	127	NB17053	129
NB1014	15	NB11617	113	NB12457	105	NB13514	110	NB14463	116	NB16063	127	NB17060	129
NB1021	15	NB11624	113	NB12458	105	NB13516	110	NB14466	116	NB16070	127	NB17084	129
NB102148	126	NB11631	113	NB12459	104	NB13518	110	NB14469	116	NB16087	127	NB17091	129
NB102168	10	NB11648	113	NB1246	22	NB13520	110	NB14472	116	NB161	9	NB17107	129
NB102168	171	NB11650	114	NB12460	105	NB13522	110	NB14475	116	NB1618	28	NB17114	129
NB102169	10	NB11655	114	NB12461	105	NB13524	110	NB14500	118	NB16230	128	NB17121	129
NB102169	171	NB11662	114	NB12463	105	NB13526	110	NB14503	118	NB16247	128	NB17138	129
NB102170	10	NB11679	114	NB12464	105	NB13528	110	NB14506	118	NB1625	28	NB17145	129
NB102170	171	NB11709	146	NB12465	104	NB13530	110	NB14509	118	NB16254	128	NB17152	129
NB10283	100	NB11709	113	NB12466	105	NB13532	110	NB14512	118	NB16261	128	NB17169	129
NB10285	100	NB11716	146	NB12467	105	NB13534	110	NB14515	118	NB16278	128	NB17176	129
NB10290	100	NB11716	113	NB12468	104	NB13536	110	NB14518	118	NB16285	128	NB17183	129
NB10306	100	NB11723	146	NB12469	105	NB13538	110	NB14521	118	NB16290	128	NB17190	129
NB10313	100	NB11723	113	NB12470	105	NB13540	110	NB14524	118	NB16292	128	NB17206	129
NB10337	54	NB11730	146	NB12471	104	NB13541	110	NB14527	118	NB16294	128	NB17213	129
NB10337	102	NB11730	113	NB12472	105	NB13542	110	NB14530	118	NB16308	128	NB172151	184
NB1038	15	NB11747	146	NB12473	105	NB13546	110	NB14533	118	NB16315	128	NB172168	184
NB10641	106	NB11747	113	NB12474	104	NB13548	110	NB14536	118	NB16322	128	NB17220	129
NB10658	106	NB11754	146	NB12475	105	NB13550	110	NB14539	118	NB16339	128	NB17237	129
NB10665	106	NB11754	113	NB12476	105	NB13552	110	NB14542	118	NB16346	128	NB17244	129
NB10672	106	NB11761	146	NB12477	104	NB13554	110	NB14545	118	NB16353	128	NB17251	129
NB10689	106	NB11761	113	NB12479	105	NB1366	24	NB14548	118	NB16360	128	NB17268	129
NB10696	106	NB11778	146	NB12480	104	NB13697	115	NB14551	118	NB16377	128	NB17275	129
NB10702	106	NB11778	113	NB12482	105	NB13703	115	NB14554	118	NB16384	128	NB17282	129
NB10719	106	NB11785	146	NB12483	104	NB13710	115	NB14557	118	NB16391	126	NB17299	129
NB10726	106	NB11785	113	NB12485	105	NB13864	111	NB14560	118	NB16407	126	NB172990	41
NB10733	106	NB11792	114	NB12486	104	NB13871	111	NB14563	118	NB16409	126	NB172992	41
NB10740	106	NB11808	114	NB12489	104	NB13888	111	NB14566	118	NB16414	126	NB172994	41
NB10757	106	NB11877	103	NB1249	22	NB13895	111	NB14569	118	NB16421	126	NB172996	41
NB10771	106	NB11878	103	NB12492	104	NB13901	111	NB14572	118	NB16424	126	NB173000	41
NB10788	106	NB11884	103	NB12495	104	NB13918	111	NB14575	118	NB16427	126	NB173006	41
NB10795	106	NB11885	103	NB12499	105	NB13925	111	NB1458	18	NB16430	126	NB173008	41
NB10801	106	NB11891	103	NB1252	22	NB13932	111	NB14580	117	NB16445	168	NB17305	129
NB10818	106	NB11892	103	NB1255	22	NB13949	111	NB14582	117	NB16452	168	NB17312	129
NB10825	106	NB11907	103	NB129773	50	NB13956	111	NB14584	117	NB16469	168	NB17329	129
NB109	8	NB11908	103	NB1298	24	NB13963	111	NB14586	117	NB16476	168	NB17336	129
NB112000	56	NB11914	103	NB130	9	NB13970	111	NB14588	117	NB16478	168	NB17336	129
NB112001	56	NB11915	103	NB1304	24	NB13987	111	NB14600	117	NB16480	168	NB17343	130
NB112002	56	NB11921	103	NB13060	106	NB13994	111	NB14602	117	NB16482	168	NB17350	130
NB112003	57	NB11922	103	NB13093	106	NB14014	111	NB14604	117	NB16483	168	NB17374	130
NB112004	57	NB11938	103	NB13100	106	NB1403	24	NB14606	117	NB16484	168	NB17381	130
NB112005	58	NB11939	103	NB13109	106	NB14038	111	NB14608	117	NB16486	168	NB173910	40
NB112006	58	NB11942	103	NB1311	24	NB14069	111	NB14620	117	NB16486	168	NB173912	40
NB112007	59	NB11945	103	NB13112	106	NB14076	111	NB14622	117	NB16506	112	NB173929	40
NB112008	59	NB11946	103	NB13116	106	NB14083	111	NB14624	117	NB16513	112	NB173936	40
NB112009	59	NB11949	103	NB13118	106	NB1410	18	NB14626	117	NB16520	112	NB173943	40
NB112010	57	NB11952	103	NB13120	106	NB14106	111	NB14628	117	NB16537	112	NB173950	40
NB112011	56	NB11969	103	NB13124	106	NB14113	111	NB14628	117	NB16544	112	NB17398	130
NB112012	56	NB11970	103	NB13126	106	NB14120	111	NB14630	116	NB16551	112	NB174010	192
NB112013	57	NB121006	30	NB13154	107	NB14137	111	NB14632	116	NB16558	112	NB174012	192
NB112014	57	NB121007	30	NB13161	107	NB14144	111	NB14634	116	NB16582	112	NB174014	192
NB112015	56	NB121008	30	NB13178	107	NB14151	111	NB14636	116	NB16599	112	NB174018	192
NB112016	58	NB121009	30	NB13185	107	NB14168	111	NB14637	116	NB16605	112	NB174020	192
NB112017	58	NB121010	30	NB13192	107	NB14175	111	NB1465	18	NB16612	112	NB174022	192
NB112018	58	NB1212	22	NB13208	107	NB14182	111	NB147	9	NB16636	112	NB174024	192
NB112019	59	NB1229	22	NB13215	108	NB14199	111	NB1472	18	NB16643	112	NB174028	192
NB112020	59	NB12340	104	NB13222	108	NB14205	111	NB1489	18	NB16650	170	NB174032	192
NB112021	57	NB12343	104	NB13239	108	NB14229	111	NB1496	28	NB16667	170	NB174036	192
NB112800	95	NB12346	104	NB13246	108	NB14236	111	NB1502	28	NB16674	170	NB17404	130
NB112801	95	NB12355	104	NB13253	108	NB14243	111	NB151064	53	NB16681	170	NB174040	191
NB112802	95	NB1236	22	NB13260	108	NB1427	18	NB151071	53	NB16698	170	NB174042	191
NB112803	95	NB12379	104	NB13277	109	NB1434	18	NB1533	28	NB16728	40	NB174044	191
NB112804	95	NB12386	104	NB1328	24	NB14400	116	NB154	9	NB167935	40	NB174046	191
NB112805	95	NB12393	104	NB13284	109	NB14403	116	NB1540	28	NB167941	41	NB174050	191
NB112806	95	NB12409	104	NB13291	109	NB14406	116	NB15523	119	NB167942	40	NB174063	191
NB112807	95	NB12412	104	NB13307	109	NB14409	116	NB15527	119	NB167950	40	NB174066	184
NB112808	95	NB12416	104	NB13314	109	NB1441	18	NB15530	119	NB167966	41	NB174070	191
NB112809	95	NB12420	104	NB13321	109	NB1441	166	NB15534	119	NB167973	41	NB174087	191
NB112810	95	NB12423	104	NB13338	109	NB1441	166	NB1571	28	NB167980	41	NB174088	184
NB112890	96	NB12426	104	NB13345	109	NB1441	168	NB15790	78	NB167985	41	NB174090	184
NB112891	96	NB12429	104	NB13352	109	NB1441	168	NB15806	78	NB168093	40	NB174092	184
NB112891	96	NB1243	22	NB13369	109	NB14412	116	NB15813	78	NB168109	40	NB174094	184
NB112892	96	NB12430	105	NB13376	109	NB14415	116	NB15820	78	NB168116	40	NB174095	184
NB112893	96	NB12432	104	NB13383	109	NB14418	116	NB15837	78	NB168120	40	NB174098	184
NB112894	96	NB12433	105	NB13390	109	NB14421	116	NB15844	78	NB16858	127	NB174100	184
NB112895	96	NB12436	105	NB13390	109	NB14424	116	NB15851	78	NB16865	127	NB174105	184
NB112896	96	NB12439	105	NB13406	109	NB14427	116	NB15868	78	NB16872	127	NB17411	130
NB112897	96	NB12442	105	NB13413	109	NB14430	116	NB1588	28	NB16887	127	NB174110	184
NB112898	96	NB12445	105	NB1342	24	NB14433	116	NB15912	107	NB16889	127	NB174110	184
NB112899	96	NB12448	105	NB13420	109	NB14436	116	NB15929	107	NB16940	129	NB17435	130
NB11556	113	NB12450	104	NB13437	109	NB14439	116	NB15936	107	NB16957	129	NB17442	130
NB11563	113	NB12451	105	NB13451	109	NB14442	116	NB1595	28	NB16964	129	NB17466	130
NB11570	113	NB12452	105	NB13468	109	NB14445	116	NB1601	28	NB16971	129	NB17473	130
NB11587	113	NB12453	104	NB13475	109	NB14448	116	NB1602	28	NB16995	129	NB17480	130
NB11594	113	NB12454	105	NB13482	109	NB14451	116	NB16018	127	NB17	8	NB17497	130
NB116	9	NB12455	105	NB13499	109	NB14454	116	NB16025	127	NB17015	129	NB175100	74
				NB13510	110	NB14457	116	NB16032	127	NB17022	129	NB175105	74
								NB16049	127	NB17039	129	NB175110	74

Codice	Pagina	Codice	Pagina	Codice	Pagina	Codice	Pagina	Codice	Pagina	Codice	Pagina	Codice	Pagina
NB175115	74	NB192	9	NB22613	194	NB25082	122	NB3025	16	NB36566	131	NB40176	210
NB175200	74	NB195501	42	NB22620	194	NB25084	122	NB3032	16	NB36573	131	NB40180	210
NB175205	74	NB195518	42	NB2264	5	NB25086	122	NB30397	126	NB36580	131	NB40184	210
NB175210	74	NB195525	42	NB22651	195	NB25088	122	NB30403	126	NB36597	131	NB40188	210
NB175215	74	NB195532	42	NB22668	195	NB25090	122	NB30427	126	NB36610	131	NB40194	210
NB175300	74	NB19590	53	NB22675	195	NB25092	122	NB30434	126	NB36639	131	NB40200	210
NB175305	74	NB19606	53	NB22682	195	NB25094	122	NB3049	16	NB36641	131	NB40204	210
NB175310	74	NB19613	53	NB22699	195	NB25100	123	NB3056	15	NB36658	131	NB40208	210
NB175315	74	NB19620	53	NB2270	5	NB25102	123	NB3063	15	NB36672	131	NB40214	210
NB175320	74	NB19637	53	NB22705	195	NB25104	123	NB3070	15	NB36689	131	NB40220	210
NB175325	74	NB197	10	NB22767	195	NB25106	123	NB3087	15	NB36696	131	NB40226	210
NB175400	75	NB1977	27	NB22774	195	NB25108	123	NB3094	15	NB36702	131	NB40232	210
NB175405	75	NB1984	27	NB22804	195	NB25110	123	NB31	8	NB3711	70	NB40238	210
NB175410	75	NB1991	26	NB23009	196	NB25112	123	NB3100	15	NB3728	70	NB40244	210
NB175415	75	NB2004	26	NB23023	196	NB25114	123	NB3117	15	NB3735	70	NB40250	210
NB175420	75	NB2011	26	NB23047	196	NB25116	123	NB3124	15	NB3800	70	NB40256	210
NB175425	75	NB2028	26	NB23085	196	NB25118	123	NB3216	19	NB3803	70	NB40260	210
NB175500	75	NB2035	26	NB23108	196	NB25150	123	NB3223	19	NB3810	70	NB40268	210
NB175505	75	NB2042	10	NB23122	196	NB25152	123	NB3230	19	NB38113	137	NB40276	210
NB175510	75	NB20558	48	NB23238	199	NB25154	123	NB3247	19	NB3827	71	NB40288	210
NB175515	75	NB20565	48	NB23245	199	NB25156	123	NB3254	19	NB3834	71	NB40296	210
NB175520	75	NB20572	48	NB2325	5	NB25158	123	NB3261	19	NB3841	72	NB4030	142
NB175600	75	NB2059	10	NB23276	199	NB25160	123	NB3278	19	NB3858	72	NB40300	210
NB175605	75	NB2066	10	NB23405	198	NB25162	123	NB3285	19	NB38584	133	NB40304	210
NB175610	75	NB2073	11	NB23412	198	NB25164	123	NB3292	167	NB38591	133	NB40308	210
NB175615	75	NB208	9	NB23414	199	NB25166	123	NB3308	167	NB38600	137	NB40314	210
NB175620	75	NB2080	11	NB23450	199	NB25168	123	NB3322	169	NB38610	137	NB40320	210
NB17641	50	NB2090017	189	NB23467	199	NB25170	123	NB3339	169	NB38611	137	NB40324	210
NB17658	50	NB2090018	189	NB23481	199	NB25172	123	NB3346	169	NB38612	137	NB40328	210
NB17665	50	NB209066	185	NB2349	5	NB25174	123	NB3353	169	NB38613	137	NB40332	210
NB17672	50	NB209088	185	NB23498	199	NB25176	123	NB33602	19	NB3865	72	NB40336	210
NB17689	50	NB209099	185	NB239	9	NB25178	123	NB33619	19	NB38700	137	NB40340	210
NB17696	51	NB209308	185	NB2391	5	NB25180	123	NB33626	19	NB38710	137	NB40419	208
NB17702	51	NB209506	185	NB2392	5	NB25182	123	NB33688	20	NB38711	137	NB40420	208
NB17719	51	NB209640	189	NB23930	198	NB25184	123	NB33695	20	NB38712	137	NB40422	208
NB17726	51	NB2097	11	NB23932	198	NB25186	123	NB33701	20	NB3872	73	NB40424	208
NB17733	51	NB2141	27	NB23934	198	NB25200	124	NB33718	20	NB38800	137	NB40426	208
NB17740	51	NB215	9	NB23936	198	NB25202	124	NB34180	29	NB38810	137	NB40428	208
NB17757	51	NB2158	27	NB23938	198	NB25204	124	NB34180	102	NB38811	137	NB40430	208
NB17764	51	NB2165	27	NB2394	5	NB25206	124	NB34371	147	NB38812	137	NB40432	208
NB17771	52	NB21715	190	NB23940	198	NB25208	124	NB3438	170	NB38843	134	NB40433	208
NB17788	52	NB2172	27	NB23942	198	NB25210	124	NB34388	147	NB3889	73	NB40440	208
NB17795	52	NB21722	190	NB23944	198	NB25212	124	NB34395	147	NB38898	134	NB40457	208
NB178	9	NB21739	190	NB23948	200	NB25214	124	NB34401	147	NB38904	134	NB40464	208
NB178000	76	NB21746	190	NB2395	5	NB25216	124	NB34418	147	NB38911	134	NB40471	208
NB17801	52	NB21753	190	NB24	8	NB25260	124	NB34425	147	NB38928	134	NB40488	208
NB17818	52	NB21760	190	NB2400	5	NB25262	124	NB34432	147	NB3900	71	NB40495	208
NB178220	77	NB21777	190	NB2402	5	NB25264	124	NB34449	147	NB3910	70	NB40501	208
NB178225	77	NB21784	190	NB2404	5	NB25266	124	NB3445	170	NB3919	71	NB40518	208
NB17825	52	NB21791	191	NB24044	201	NB25268	124	NB34456	147	NB39200	219	NB40525	208
NB178330	77	NB21807	191	NB2406	5	NB25270	124	NB34463	147	NB39202	219	NB40532	208
NB178335	77	NB21814	191	NB2408	5	NB25272	124	NB34470	147	NB39204	219	NB4055	143
NB178430	77	NB21821	191	NB2410	5	NB25274	124	NB34570	34	NB39206	219	NB4057	143
NB178435	77	NB21838	191	NB2412	5	NB25276	124	NB34579	34	NB39208	219	NB4060	144
NB178440	76	NB21848	193	NB2414	5	NB25278	124	NB34582	34	NB39210	219	NB40602	221
NB178442	76	NB21850	193	NB2416	5	NB25280	124	NB34586	34	NB39212	219	NB40604	221
NB178444	76	NB21852	193	NB2418	5	NB25282	124	NB34590	34	NB39214	219	NB40610	219
NB178445	76	NB21876	195	NB246	9	NB25284	124	NB34593	34	NB39216	219	NB40612	219
NB178980	76	NB21883	195	NB2462	5	NB25286	124	NB34600	34	NB39218	219	NB40614	219
NB178985	76	NB2189	27	NB2480	5	NB25290	124	NB34609	34	NB39220	219	NB40616	219
NB179106	39	NB21890	195	NB2496	5	NB25292	124	NB34615	34	NB39222	219	NB40618	219
NB179108	39	NB22002	193	NB25000	122	NB25294	124	NB34620	34	NB39224	219	NB40620	219
NB179116	39	NB22019	193	NB25002	122	NB25296	124	NB34625	34	NB39226	219	NB40622	219
NB179118	39	NB22026	193	NB25004	122	NB25298	124	NB34629	34	NB39228	219	NB40624	219
NB179126	39	NB22033	192	NB25006	122	NB253	9	NB34635	34	NB39230	219	NB40630	219
NB179128	39	NB22040	192	NB25008	122	NB25540	125	NB34640	34	NB3926	71	NB40632	219
NB179206	184	NB22057	192	NB25010	122	NB25542	125	NB34645	34	NB3933	71	NB40634	219
NB179208	184	NB22064	197	NB25014	122	NB25545	125	NB3469	170	NB3934	71	NB40640	220
NB185	9	NB22071	197	NB25016	122	NB25547	125	NB3476	170	NB3940	71	NB40642	220
NB187667	40	NB22088	197	NB25018	122	NB260	9	NB3483	170	NB3950	73	NB40644	220
NB187674	40	NB22095	197	NB25020	122	NB277	8	NB35110	136	NB3960	72	NB40646	220
NB187698	40	NB22125	194	NB25022	122	NB2974	16	NB35111	136	NB39707	212	NB40648	220
NB187704	40	NB22132	194	NB25050	122	NB29742	27	NB35112	136	NB39710	212	NB40650	220
NB187759	40	NB22149	194	NB25052	122	NB29803	92	NB35113	136	NB39727	212	NB40652	220
NB187768	40	NB22156	194	NB25054	122	NB2981	16	NB35125	136	NB39741	212	NB40654	220
NB187800	43	NB222	9	NB25058	122	NB29810	92	NB35126	136	NB39765	212	NB40660	220
NB187810	43	NB22217	197	NB25060	122	NB29827	69	NB35132	136	NB39772	212	NB40662	220
NB187820	43	NB22224	197	NB25062	122	NB29827	84	NB35149	136	NB39789	212	NB40664	220
NB187830	43	NB2240	5	NB25064	122	NB29834	85	NB35156	136	NB39796	212	NB40670	220
NB187844	42	NB22415	194	NB25066	122	NB29841	88	NB35163	136	NB39819	212	NB40672	220
NB187844	102	NB22422	194	NB25068	122	NB29841	89	NB35170	136	NB39833	212	NB40674	220
NB187851	42	NB22439	194	NB25070	122	NB29896	146	NB3610	64	NB39840	212	NB40676	220
NB187851	102	NB22446	194	NB25072	122	NB29896	113	NB3612	64	NB39857	212	NB40678	220
NB187858	42	NB22576	194	NB25074	122	NB2998	16	NB36542	131	NB39859	212	NB40680	220
NB187858	102	NB22583	194	NB25076	122	NB3001	16	NB36545	131	NB39861	212	NB40682	220
NB187865	42	NB22590	194	NB25078	122	NB30021	135	NB36550	131	NB39863	212	NB40684	220
NB187865	102	NB22606	194	NB25080	122	NB3018	16	NB36559	131	NB40170	210	NB40686	220

Codice	Pagina	Codice	Pagina	Codice	Pagina	Codice	Pagina	Codice	Pagina	Codice	Pagina	Codice	Pagina
NB40688	220	NB41323	213	NB41874	146	NB43912	217	NB48804	84	NB50195	178	NB53360	4
NB40690	220	NB41339	213	NB41876	146	NB43915	217	NB48828	84	NB50196	178	NB53362	4
NB40827	209	NB41341	213	NB4216	145	NB43918	217	NB48835	84	NB50205	178	NB53364	4
NB40829	209	NB41345	213	NB4221	145	NB43921	217	NB48842	84	NB50215	178	NB53372	82
NB40831	209	NB41348	213	NB4229	145	NB43930	215	NB48859	84	NB50245	178	NB53372	169
NB40833	209	NB41351	213	NB42598	208	NB43950	217	NB48866	84	NB50400	168	NB53396	137
NB40835	209	NB41354	213	NB42604	208	NB43953	217	NB48873	85	NB50412	168	NB53471	137
NB40837	209	NB41363	213	NB42611	208	NB43956	217	NB48880	85	NB50420	179	NB53587	127
NB4084	145	NB41366	213	NB42628	208	NB43959	217	NB48897	85	NB50423	178	NB53693	131
NB40843	209	NB41369	213	NB42635	208	NB44066	137	NB48903	85	NB5043	43	NB5371	47
NB40845	209	NB41372	213	NB42642	208	NB44101	134	NB48910	85	NB50430	178	NB53716	82
NB40851	209	NB41378	213	NB42659	208	NB44103	134	NB48927	85	NB50435	178	NB53792	82
NB40857	209	NB4138	146	NB42666	208	NB44202	135	NB48941	85	NB50440	179	NB53792	169
NB40863	209	NB41387	213	NB42668	208	NB44219	135	NB48965	85	NB50445	179	NB53808	34
NB40869	209	NB41390	213	NB42680	208	NB44226	135	NB48972	85	NB50448	179	NB53811	34
NB40875	209	NB41393	213	NB42697	208	NB44233	135	NB48989	85	NB50450	179	NB53815	34
NB40881	209	NB41399	213	NB42703	208	NB44240	135	NB48996	85	NB50453	179	NB53820	34
NB40887	209	NB41408	213	NB42710	208	NB44257	135	NB49009	85	NB50455	179	NB53825	34
NB40893	209	NB41411	213	NB42727	208	NB44356	112	NB49016	66	NB50548	45	NB53830	34
NB40899	209	NB41414	213	NB42734	208	NB44363	112	NB49023	66	NB50600	171	NB53835	34
NB40905	209	NB41420	213	NB42741	208	NB44370	112	NB49030	64	NB5067	43	NB53840	34
NB4091	145	NB41441	213	NB42758	208	NB44387	112	NB49047	64	NB50695	173	NB53845	34
NB40911	209	NB41444	213	NB42765	208	NB44387	112	NB49276	87	NB5074	43	NB53850	34
NB40917	209	NB41447	213	NB42772	208	NB44851	130	NB49283	87	NB50784	45	NB53855	34
NB40923	209	NB4145	146	NB42789	208	NB44875	20	NB49375	48	NB50906	166	NB53891	82
NB40929	209	NB41453	213	NB42796	208	NB44882	20	NB49382	48	NB51030	141	NB53921	131
NB40935	209	NB41461	213	NB42819	208	NB44899	29	NB49399	48	NB51040	141	NB54110	4
NB40941	209	NB41462	213	NB42840	208	NB44905	29	NB49405	45	NB5166	43	NB54115	4
NB40943	209	NB41463	213	NB42871	208	NB44950	83	NB49597	45	NB5173	43	NB54120	4
NB40949	209	NB41465	213	NB43236	112	NB44967	83	NB49603	45	NB51835	45	NB54125	4
NB4095	145	NB41467	213	NB43243	112	NB44974	133	NB49610	45	NB51842	45	NB54130	4
NB40955	209	NB41468	213	NB43250	112	NB44981	133	NB49700	220	NB51910	45	NB54287	4
NB40961	209	NB41469	213	NB43300	215	NB44998	133	NB49702	220	NB51941	131	NB54292	4
NB40971	209	NB41471	213	NB43303	215	NB45001	133	NB49704	220	NB51958	131	NB54294	4
NB40981	209	NB41474	213	NB43306	215	NB45018	133	NB49706	220	NB51958	131	NB54300	4
NB40989	209	NB41475	213	NB43309	215	NB45025	133	NB49710	220	NB52016	166	NB54355	142
NB40995	209	NB41477	213	NB43312	215	NB45032	133	NB49712	220	NB5203	45	NB5463	27
NB41001	209	NB41480	213	NB43315	215	NB45049	133	NB49714	220	NB52139	62	NB5470	27
NB41009	209	NB41483	213	NB43318	215	NB45056	133	NB49716	220	NB52216	28	NB5477	27
NB41013	209	NB41486	213	NB43321	215	NB45063	133	NB49770	220	NB52225	28	NB5487	27
NB41017	209	NB41489	213	NB43324	215	NB45070	133	NB49780	109	NB52240	28	NB5494	27
NB41021	209	NB41500	214	NB43330	215	NB45087	133	NB49781	109	NB52250	28	NB54973	140
NB41025	209	NB41503	214	NB43333	215	NB45094	133	NB49782	109	NB52254	29	NB54980	140
NB41029	209	NB41506	214	NB43336	215	NB45100	133	NB49783	109	NB52273	29	NB55	8
NB41037	209	NB41515	214	NB43339	215	NB45117	133	NB49784	109	NB52280	29	NB55345	127
NB4107	145	NB4152	146	NB43341	215	NB45216	133	NB49785	109	NB52288	29	NB55352	127
NB41119	114	NB41527	214	NB43341	215	NB45223	133	NB49786	109	NB52979	4	NB55369	127
NB41140	211	NB41533	214	NB43600	218	NB45230	133	NB49788	109	NB52986	4	NB55376	127
NB41142	211	NB41554	214	NB43603	218	NB45247	133	NB49790	109	NB52988	4	NB55383	127
NB41144	211	NB41557	214	NB43606	218	NB45254	133	NB49795	108	NB52993	4	NB56185	2
NB41146	211	NB41563	214	NB43609	218	NB45261	133	NB49801	108	NB53006	4	NB56190	2
NB41148	211	NB41563	214	NB43612	218	NB45278	133	NB49818	108	NB53013	4	NB56200	2
NB41152	211	NB41575	214	NB43615	218	NB45285	133	NB49825	108	NB53014	4	NB56205	2
NB41152	211	NB41578	214	NB43617	218	NB45292	133	NB49832	108	NB53020	4	NB56210	2
NB41156	211	NB41584	214	NB43621	218	NB45292	133	NB49849	108	NB53025	4	NB56215	2
NB41160	211	NB41584	214	NB43624	218	NB45300	133	NB49856	108	NB53037	4	NB56300	2
NB41164	211	NB41590	214	NB43624	218	NB45414	146	NB49865	108	NB53039	4	NB56305	2
NB41164	211	NB41599	214	NB43627	218	NB45421	146	NB49887	108	NB53041	4	NB56307	2
NB41170	211	NB41605	214	NB43630	218	NB45425	146	NB50050	174	NB53043	4	NB56310	2
NB41174	211	NB41608	214	NB43750	218	NB45441	146	NB50055	175	NB53044	4	NB56315	2
NB41178	211	NB41611	214	NB43753	218	NB45421	146	NB50075	175	NB53047	4	NB56320	2
NB41180	211	NB41614	214	NB43756	218	NB45425	146	NB50090	174	NB53049	4	NB56390	2
NB41186	211	NB41620	214	NB43790	218	NB45425	146	NB50110	175	NB53075	4	NB56400	2
NB41190	211	NB41623	214	NB43800	216	NB45425	146	NB50120	175	NB53082	4	NB56405	2
NB41194	211	NB41632	214	NB43803	216	NB45425	146	NB50130	176	NB53211	26	NB56407	2
NB41198	211	NB41635	214	NB43806	216	NB45425	146	NB50135	176	NB53228	26	NB56410	2
NB41204	211	NB41638	214	NB43809	216	NB45425	146	NB50145	177	NB53235	26	NB56415	2
NB4121	146	NB41647	214	NB43812	216	NB45425	146	NB50148	176	NB53242	26	NB56420	2
NB41212	211	NB41650	214	NB43815	216	NB45425	146	NB50168	177	NB53259	26	NB56520	2
NB41218	211	NB41653	214	NB43818	216	NB45425	146	NB50171	177	NB53341	4	NB56545	2
NB41224	211	NB41656	214	NB43821	216	NB45425	146	NB50182	177	NB53358	4	NB56600	2
NB41228	211	NB41662	214	NB43824	216	NB45425	146						
NB41232	211	NB41665	214	NB43827	216	NB45425	146						
NB41238	211	NB41668	214	NB43829	216	NB45425	146						
NB41244	211	NB41674	214	NB43833	216	NB45425	146						
NB41248	211	NB41683	131	NB43836	216	NB45425	146						
NB41252	211	NB41692	214	NB43850	216	NB45425	146						
NB41258	211	NB41695	214	NB43853	216	NB45425	146						
NB41262	211	NB41701	214	NB43856	216	NB45425	146						
NB41266	211	NB41710	214	NB43859	216	NB45425	146						
NB41270	211	NB41713	214	NB43862	216	NB45425	146						
NB41274	211	NB41716	214	NB43865	216	NB45425	146						
NB41276	211	NB41719	214	NB43868	216	NB45425	146						
NB41300	213	NB41836	145	NB43871	216	NB45425	146						
NB41303	213	NB41867	146	NB43880	217	NB45425	146						
NB41312	213	NB41868	146	NB43900	217	NB45425	146						
NB41315	213	NB41870	146	NB43903	217	NB45425	146						
NB41318	213	NB41872	146	NB43906	217	NB45425	146						

Codice	Pagina	Codice	Pagina	Codice	Pagina	Codice	Pagina	Codice	Pagina	Codice	Pagina	Codice	Pagina
NB56605	2	NB59673	4	NB61543	4	NB63692	128	NB69281	197	NB72526	73	NB74445	132
NB56610	2	NB59718	33	NB61545	4	NB63708	128	NB69298	197	NB72533	144	NB74452	132
NB56670	2	NB59720	33	NB61582	30	NB63715	128	NB69300	197	NB72540	144	NB74469	132
NB56770	2	NB59722	33	NB61599	30	NB63722	128	NB69302	197	NB72557	144	NB74476	132
NB57113	3	NB59724	33	NB61605	30	NB63810	137	NB69304	197	NB72564	144	NB74483	132
NB57116	3	NB59726	33	NB61612	30	NB63814	137	NB69308	197	NB72571	144	NB74490	132
NB57119	3	NB59740	33	NB61629	30	NB63845	140	NB69312	197	NB72595	70	NB74506	132
NB57130	3	NB59742	33	NB61636	30	NB63850	140	NB7030	78	NB72600	70	NB74513	132
NB57133	3	NB59744	33	NB61643	30	NB64156	12	NB7035	78	NB72601	70	NB74520	132
NB57136	3	NB59746	33	NB61650	30	NB64163	12	NB7047	78	NB72618	71	NB74643	80
NB57139	3	NB59748	33	NB61667	30	NB64170	12	NB7054	78	NB72625	71	NB74650	80
NB5715	169	NB59760	33	NB61674	30	NB64187	12	NB7061	78	NB72630	71	NB74667	80
NB57150	3	NB59762	33	NB61700	31	NB64194	12	NB7078	78	NB7269	81	NB74674	80
NB57153	3	NB59764	33	NB61705	31	NB64927	78	NB7085	78	NB7276	81	NB74766	132
NB57156	3	NB59766	33	NB61707	31	NB65948	44	NB7090	78	NB7283	81	NB74773	132
NB57159	3	NB59770	33	NB61710	31	NB6600	148	NB71499	69	NB72850	72	NB74780	132
NB57163	3	NB59772	33	NB61715	31	NB6601	148	NB71499	87	NB72858	72	NB7481	60
NB57166	3	NB59774	33	NB61720	31	NB6603	148	NB71529	191	NB72872	73	NB74889	45
NB57170	3	NB59776	33	NB61725	31	NB6605	148	NB7153	81	NB72885	55	NB74902	44
NB57173	3	NB59779	33	NB61730	31	NB66150	65	NB71536	191	NB7290	81	NB7498	60
NB57176	3	NB59792	33	NB61735	31	NB6620	149	NB71543	191	NB73141	189	NB74988	4
NB57190	3	NB59794	33	NB61740	31	NB6621	149	NB71550	191	NB73158	189	NB74995	45
NB57193	3	NB59800	32	NB61745	31	NB6625	151	NB71567	193	NB33633	19	NB75008	44
NB57196	3	NB59802	32	NB61748	31	NB6626	151	NB71598	198	NB73486	100	NB75015	44
NB5790	171	NB59804	32	NB61750	31	NB6628	151	NB7160	81	NB73875	10	NB75022	44
NB58000	6	NB59806	32	NB61755	31	NB6630	148	NB71604	198	NB73882	11	NB75039	44
NB58005	6	NB59824	32	NB61757	31	NB6631	148	NB71611	198	NB73905	55	NB75044	45
NB58010	6	NB59828	32	NB61759	31	NB6635	148	NB71628	198	NB73967	49	NB75046	45
NB58015	6	NB59830	32	NB61760	31	NB6638	148	NB71633	200	NB73974	49	NB75053	45
NB58020	6	NB59832	32	NB61762	31	NB6650	149	NB71640	200	NB73981	49	NB75060	45
NB58025	6	NB59833	32	NB61765	31	NB66500	172	NB71673	200	NB74018	118	NB75077	44
NB58030	6	NB59834	32	NB61768	31	NB6652	149	NB71765	191	NB74020	118	NB75107	27
NB58035	6	NB59850	32	NB61770	31	NB66617	173	NB7177	81	NB74030	120	NB7511	60
NB58040	6	NB59852	32	NB61772	31	NB6662	150	NB7178	81	NB74033	120	NB75114	27
NB58045	6	NB59854	32	NB61774	31	NB6671	152	NB71826	200	NB74036	120	NB75121	27
NB58050	6	NB59858	32	NB61775	31	NB66800	173	NB7184	81	NB74039	120	NB75138	44
NB58055	6	NB59860	32	NB61777	31	NB6681	152	NB71864	200	NB74042	120	NB75145	44
NB58060	6	NB59880	32	NB61779	31	NB66853	86	NB71871	200	NB74045	120	NB75152	44
NB58065	6	NB59882	32	NB61780	31	NB66860	86	NB71888	200	NB74080	121	NB75169	44
NB58070	145	NB59884	32	NB61782	31	NB66877	86	NB7191	81	NB74083	121	NB75176	44
NB58075	6	NB59888	32	NB61784	31	NB66884	86	NB71963	185	NB74086	121	NB75183	44
NB58080	6	NB5996	68	NB61785	31	NB66891	86	NB71970	185	NB74089	121	NB75190	44
NB58085	6	NB5998	68	NB61787	31	NB66907	86	NB71987	185	NB74092	121	NB75206	45
NB58090	6	NB5999	66	NB61789	31	NB66914	86	NB71994	185	NB74095	121	NB75213	45
NB58095	6	NB6002	68	NB61790	31	NB66921	86	NB72002	186	NB74098	121	NB75220	45
NB58100	6	NB6006	68	NB61791	31	NB66938	86	NB72004	186	NB74101	121	NB75237	45
NB58105	6	NB6008	68	NB61820	141	NB66945	86	NB72006	186	NB74105	47	NB75244	46
NB58110	6	NB6019	68	NB61827	141	NB6700	154	NB72010	185	NB74106	47	NB75251	46
NB58115	6	NB60196	12	NB61834	145	NB6705	154	NB72012	185	NB74108	47	NB75268	46
NB58120	6	NB60202	12	NB61841	145	NB6740	154	NB72015	185	NB74110	47	NB75275	46
NB58125	6	NB60219	12	NB61858	145	NB6745	154	NB72045	188	NB74117	83	NB7528	60
NB58130	6	NB60219	167	NB62039	45	NB6760	155	NB72052	188	NB74124	83	NB75282	44
NB58134	145	NB60226	12	NB62046	45	NB6799	155	NB72069	188	NB74131	83	NB75343	45
NB5814	145	NB60233	12	NB62053	82	NB68000	172	NB7207	81	NB74148	83	NB7535	60
NB5821	145	NB6026	68	NB62053	169	NB6810	156	NB72076	188	NB74155	44	NB75404	45
NB5828	145	NB6027	82	NB62060	82	NB6830	156	NB72083	188	NB74160	83	NB75411	46
NB5838	145	NB6028	68	NB62060	169	NB6840	156	NB72090	188	NB74162	45	NB7542	61
NB5876	153	NB6030	68	NB62077	82	NB6842	140	NB72106	188	NB74163	83	NB75428	46
NB5883	64	NB6033	65	NB62077	169	NB6850	153	NB72113	187	NB74166	83	NB75435	46
NB5890	64	NB6040	65	NB62084	82	NB6859	143	NB72120	187	NB74169	83	NB75442	46
NB5913	64	NB6055	65	NB62084	169	NB68600	172	NB72137	188	NB74172	83	NB75466	43
NB5920	64	NB6057	65	NB62091	82	NB6866	153	NB7214	81	NB74175	83	NB75520	162
NB5927	66	NB6064	65	NB62091	169	NB6870	142	NB72144	188	NB74179	29	NB75522	162
NB5929	66	NB6070	65	NB62107	82	NB6873	142	NB72151	186	NB74186	83	NB7559	61
NB5934	66	NB6071	65	NB62107	169	NB6876	142	NB72168	186	NB74193	83	NB7566	61
NB5935	66	NB60929	86	NB62114	82	NB69038	192	NB72175	186	NB74209	83	NB7573	61
NB5937	66	NB60943	86	NB62114	169	NB69045	192	NB72182	186	NB74275	132	NB7580	61
NB5944	66	NB60950	86	NB63241	87	NB69052	192	NB72199	187	NB74277	132	NB7597	61
NB59633	4	NB60974	86	NB63487	88	NB69106	198	NB72205	187	NB74280	132	NB76051	158
NB59635	4	NB61070	24	NB63494	88	NB69113	198	NB72212	187	NB74285	132	NB76080	159
NB59640	4	NB61087	24	NB63500	88	NB69137	198	NB72212	187	NB74292	132	NB76090	158
NB59644	4	NB61094	24	NB63517	88	NB69144	198	NB72229	187	NB74308	132	NB76097	158
NB59671	4	NB61117	24	NB63524	88	NB69151	198	NB72236	187	NB74315	132	NB7610	62
		NB61087	24	NB63531	88	NB69168	201	NB72243	187	NB74322	132	NB76100	159
		NB61094	24	NB63548	79	NB69172	199	NB72311	189	NB74339	132	NB76125	159
		NB61100	24	NB63555	79	NB69174	199	NB72328	189	NB74346	132	NB76150	160
		NB61117	24	NB63562	79	NB69176	199	NB72373	190	NB74353	132	NB76152	160
		NB61124	24	NB63579	79	NB69178	199	NB72380	190	NB74360	132	NB76156	160
		NB61520	4	NB63586	79	NB69182	193	NB72397	189	NB74377	132	NB76181	161
		NB61522	4	NB63593	79	NB69199	193	NB72403	189	NB74384	132	NB76200	161
		NB61524	4	NB63609	79	NB69205	193	NB72410	190	NB74391	132	NB76250	161
		NB61526	4	NB63616	79	NB69212	193	NB72427	189	NB74407	132	NB7627	62
		NB61537	4	NB63623	79	NB69229	193	NB72434	193	NB74414	132	NB7634	62
		NB61540	4	NB63625	79	NB69267	197	NB7245	81	NB74421	132	NB7832	63
				NB63631	79	NB69274	197	NB7252	81	NB74438	132	NB7849	63

Codice	Pagina	Codice	Pagina	Codice	Pagina	Codice	Pagina	Codice	Pagina
NB7856	63	NB8747	80	NB88998	93	NB9126	85	NB9708	115
NB789	13	NB8754	80	NB89050	63	NB9133	85	NB9710	115
NB79	8	NB8761	80	NB89067	63	NB9140	85	NB9713	101
NB7924	48	NB8778	80	NB8907	82	NB9157	85	NB9719	115
NB7931	48	NB8785	82	NB8907	169	NB9164	85	NB9720	101
NB7948	48	NB87887	167	NB89074	63	NB918	14	NB9722	115
NB796	13	NB87889	167	NB8914	82	NB9188	85	NB97543	69
NB80122	180	NB87896	167	NB8914	169	NB9190	85	NB97550	69
NB80128	180	NB87900	131	NB8921	82	NB9201	85	NB97567	69
NB80142	180	NB87902	131	NB8921	169	NB9218	85	NB97574	69
NB80143	180	NB87919	131	NB8938	82	NB9225	85	NB97800	34
NB80146	181	NB8792	82	NB8938	169	NB9232	85	NB97810	34
NB80148	180	NB87933	131	NB8945	92	NB9249	85	NB97820	34
NB802	13	NB87940	131	NB895	14	NB925	14	NB97880	34
NB8044	44	NB87957	131	NB8952	92	NB9251	85	NB97888	34
NB80500	125	NB8808	82	NB89647	84	NB9254	85	NB97891	34
NB8075	47	NB8815	82	NB89654	84	NB9263	88	NB97895	34
NB8082	47	NB8822	82	NB89661	85	NB9263	89	NB97899	34
NB8099	47	NB88435	8	NB89678	85	NB9270	88	NB9812	101
NB8105	47	NB88442	8	NB8969	92	NB9270	89	NB98144	65
NB8112	47	NB88459	8	NB8976	92	NB9287	88	NB98205	143
NB819	13	NB88466	8	NB8980	92	NB9287	89	NB9829	101
NB826	13	NB88473	8	NB8983	69	NB9294	69	NB9836	101
NB833	13	NB88715	95	NB8983	84	NB9294	87	NB9843	101
NB840	13	NB88717	95	NB8985	92	NB93	8	NB9850	55
NB8556	54	NB88719	95	NB8990	84	NB9300	69	NB98632	145
NB8563	54	NB88721	95	NB9003	69	NB9300	87	NB9867	55
NB857	13	NB88723	95	NB9003	84	NB9317	69	NB9874	55
NB8570	54	NB88726	95	NB9003	84	NB9317	87	NB9881	55
NB8587	54	NB88726	95	NB901	14	NB932	14	NB98947	143
NB86	8	NB88726	95	NB9010	69	NB9324	69	NB98948	143
NB8600	79	NB88733	95	NB9010	84	NB9324	87	NB98953	16
NB8617	79	NB88735	95	NB9027	84	NB9331	69	NB98960	16
NB8624	79	NB88735	95	NB9041	84	NB9331	87	NB98977	16
NB8631	79	NB88737	95	NB9065	84	NB9478	89	NB9898	55
NB864	14	NB88737	95	NB9072	84	NB9485	89	NB98984	16
NB8648	79	NB88739	95	NB90808150	135	NB949	14	NB98991	17
NB86509	167	NB88739	95	NB90808200	135	NB9492	89	NB99004	17
NB86516	166	NB88741	95	NB9089	84	NB9508	89	NB99011	17
NB86523	166	NB88741	95	NB9096	84	NB9515	89	NB99028	17
NB86530	166	NB88743	95	NB91010160	135	NB9522	89	NB99035	17
NB86530	168	NB88743	95	NB91010200	135	NB9539	88	NB9904	55
NB86547	166	NB88780	170	NB91010250	135	NB9546	87	NB99042	17
NB86547	166	NB888	14	NB91010300	135	NB9553	87	NB99059	17
NB86547	168	NB88800	170	NB9102	84	NB95587	20	NB99066	17
NB8655	79	NB88810	170	NB91150	22	NB95594	20	NB99073	17
NB8662	79	NB88820	170	NB91153	22	NB956	14	NB99080	17
NB8679	79	NB88830	170	NB91156	22	NB95600	20	NB99097	17
NB8686	79	NB8884	78	NB91159	22	NB95617	20	NB99103	17
NB8693	80	NB88840	170	NB91162	22	NB95624	24	NB9911	55
NB8709	80	NB88850	93	NB91165	22	NB95631	24	NB9928	55
NB871	14	NB88851	93	NB91168	22	NB95648	24	NB99325	179
NB87117	130	NB88852	93	NB91171	22	NB95655	24	NB99330	179
NB87124	64	NB88853	93	NB91174	22	NB95662	24	NB99349	131
NB87124	130	NB88854	93	NB91177	22	NB95679	24	NB9935	55
NB87131	130	NB88855	93	NB91180	22	NB95686	24	NB99835	25
NB87135	130	NB88881	93	NB91183	22	NB95693	24	NB99840	25
NB87148	130	NB88882	93	NB9119	85	NB95709	24	NB99845	25
NB87155	18	NB88883	93	NB91190	23	NB95716	24	NB99850	25
NB8716	80	NB88884	93	NB91193	23	NB95723	24	NB99855	25
NB87162	18	NB88885	93	NB91196	23	NB95730	24	NB99860	25
NB87179	18	NB88886	93	NB91199	23	NB95747	24	NB99865	25
NB87186	18	NB88887	93	NB91202	23	NB95754	24	NB99870	25
NB8723	80	NB88888	93	NB91205	23	NB95761	24	NB99875	25
NB87230	67	NB88889	93	NB91208	23	NB9585	92	NB99880	25
NB87230	119	NB88890	93	NB91211	23	NB9591	92	NB99885	25
NB87247	67	NB8891	82	NB91212200	135	NB9600	94	NB99890	25
NB87247	119	NB8891	169	NB91212250	135	NB9614	92	NB99895	25
NB87254	67	NB88960	93	NB91212300	135	NB9620	92	NB99900	25
NB87254	119	NB88962	93	NB91212350	135	NB9621	92	NB99910	25
NB87261	67	NB88964	93	NB91212400	135	NB963	14		
NB87261	120	NB88966	93	NB91214	23	NB9630	101		
NB87278	67	NB88968	93	NB91217	23	NB9645	92		
NB87278	120	NB88970	93	NB91220	23	NB9653	94		
NB87285	67	NB88980	93	NB91223	23	NB9654	94		
NB87285	120	NB88982	93	NB91230	23	NB9656	96		
NB87292	67	NB88984	93	NB91233	23	NB9660	96		
NB87292	119	NB88986	93	NB91236	23	NB9676	126		
NB8730	80	NB88988	93	NB91239	23	NB9690	101		
NB87308	67	NB88990	93	NB91242	23	NB9695	96		
NB87308	119	NB88991	93	NB91245	23	NB970	14		
NB87315	67	NB88994	93	NB91248	23	NB9700	115		
NB87315	119	NB88996	93	NB91251	23	NB9702	115		
NB87322	67					NB9705	115		
NB87322	120					NB9706	101		



OUR BRANDS



seguici su



NOBEX s.r.l. Via Monviso, 5
I - 27010 Siziano (PV)
T. +39 0381 650082 - WhatsApp +39 340 4090146
mail. info@nobex.it - nobex.it



DOC000943